

# **GNS 430/430A**

*Pilot's Guide and Reference*



| Part Number              | Change Summary                                      |
|--------------------------|---|
| 190-00140-00<br>(Rev. J) | Made various layout corrections, no content changes |

| Revision | Date of Revision | Description   |
|----------|------------------|---|
| A        | 12/98            | Initial Release   |
| B        | 4/99             | Update to conform to recent SW changes                            |
| C        | 6/99             | Added Addendum  |
| D        | 7/99             | Update for SW 2.10  |
| E        | 4/00             | Update for SW 2.15  |
| F        | 7/00             | Updated Power On, Wind Vector, Crossfill, DME, and Fuel Plan      |
| G        | 5/03             | Added FDE Section, updated per SW 5.01, misc. changes             |
| H        | 5/06             | Changed to 8 inch x 8.5 inch format. Added TERRAIN, misc. changes |

Copyright © 1998-2006 Garmin Ltd. or its subsidiaries. All rights reserved.

This manual reflects the operation of Main System Software version 5.01 or later. Some differences may be observed when comparing the information in this manual to other software versions.

Garmin International, Inc., 1200 East 151st Street, Olathe, Kansas 66062 USA  
p: 913.397.8200 f: 913.397.8282

Garmin AT, Inc., 2345 Turner Road SE, Salem, Oregon 97302 USA  
p: 503.391.3411 f: 503.364.2138

Garmin (Europe) Ltd., Unit 5, The Quadrangle, Abbey Park, Industrial Estate, Romsey, SO51 9DL, U.K.  
p: 44/0870.8501241 f: 44/0870.8501251

Garmin (Asia) Corp., No. 68, Jangshu 2nd Road., Shijr, Taipei County, Taiwan  
p: 886/2.2642.9199 f: 886/2.2642-9099

Web Site Address: [www.garmin.com](http://www.garmin.com)

Visit the Garmin website for the latest updates and supplemental information concerning the operation of this and other Garmin products.

Except as expressly provided herein, no part of this manual may be reproduced, copied, transmitted, disseminated, downloaded or stored in any storage medium, for any purpose without the express written permission of Garmin. Garmin hereby grants permission to download a single copy of this manual and of any revision to this manual onto a hard drive or other electronic storage medium to be viewed for personal use, provided that such electronic or printed copy of this manual or revision must contain the complete text of this copyright notice and provided further that any unauthorized commercial distribution of this manual or any revision hereto is strictly prohibited.

Garmin®, AutoLocate®, and PhaseTrac12® are registered trademarks of Garmin Ltd. or its subsidiaries and may not be used without the express permission of Garmin.

GNS™ and Spell'N'Find™ are trademarks of Garmin Ltd. or its subsidiaries and may not be used without the express permission of Garmin.

NavData® is a registered trademark of Jeppesen, Inc.

|  |      |   |       |
|--|------|---|-------|
| <b>SECTION 1: INTRODUCTION</b> .....           | 1-1  | <b>SECTION 8: NRST PAGES</b> .....                                  | 8-1   |
| 1.1 Accessories and Packing List.....          | 1-1  | 8.1 NRST Page Group.....  | 8-1   |
| 1.2 Key and Knob Functions.....                | 1-2  | 8.2 Nearest Airport Page.....                                       | 8-4   |
| 1.3 Takeoff Tour.....                          | 1-5  | 8.3 Nearest Intersection Page.....                                  | 8-6   |
| <b>SECTION 2: COM</b> .....                    | 2-1  | 8.4 Nearest NDB Page.....   | 8-6   |
| 2.1 Communicating using the GNS 430.....       | 2-1  | 8.5 Nearest VOR Page.....   | 8-6   |
| <b>SECTION 3: NAV PAGES</b> .....              | 3-1  | 8.6 Nearest User Waypoint Page.....                                 | 8-8   |
| 3.1 Main Page Groups.....                      | 3-1  | 8.7 Nearest Center (ARTCC) Page.....                                | 8-8   |
| 3.2 NAV Page Group.....                        | 3-1  | 8.8 Nearest Flight Service Station (FSS) Page.....                  | 8-9   |
| 3.3 Default NAV Page.....                      | 3-2  | 8.9 Nearest Airspace Page.....                                      | 8-10  |
| 3.4 Map Page.....                              | 3-5  | <b>SECTION 9: VLOC RECEIVER</b> .....                               | 9-1   |
| 3.5 TERRAIN Page.....                          | 3-14 | 9.1 VLOC (VOR/LOCALIZER/GLIDESLOPE) Receiver<br>Operations.....     | 9-1   |
| 3.6 NAV/COM Page.....                          | 3-17 | <b>SECTION 10: AUX PAGES</b> .....                                  | 10-1  |
| 3.7 Position Page.....                         | 3-19 | 10.1 AUX Page Group.....  | 10-1  |
| 3.8 Satellite Status Page.....                 | 3-22 | 10.2 Flight Planning Page.....                                      | 10-2  |
| 3.9 Vertical Navigation Page.....              | 3-24 | 10.3 Utility Page.....  | 10-12 |
| <b>SECTION 4: DIRECT-TO NAVIGATION</b> .....   | 4-1  | 10.4 Setup 1 Page.....  | 10-20 |
| 4.1 Overview.....                              | 4-1  | 10.5 Setup 2 Page.....  | 10-27 |
| <b>SECTION 5: FLIGHT PLANS</b> .....           | 5-1  | <b>SECTION 11: TERRAIN INTERFACE</b> .....                          | 11-1  |
| 5.1 Flight Plan Catalog Page.....              | 5-1  | 11.1 Introduction.....  | 11-1  |
| 5.2 Active Flight Plan Page.....               | 5-8  | 11.2 TERRAIN Operation.....   | 11-2  |
| <b>SECTION 6: PROCEDURES</b> .....             | 6-1  | 11.3 TERRAIN Alerts.....  | 11-7  |
| 6.1 Approaches, Departures and Arrivals.....   | 6-1  | <b>SECTION 12: FAULT DETECTION AND<br/>EXCLUSION</b> .....          | 12-1  |
| 6.2 Non-Precision Approach Operations.....     | 6-3  | 12.1 Detection and Exclusion.....                                   | 12-1  |
| 6.3 ILS Approaches.....                        | 6-26 | 12.2 Pre-Departure Verification of FDE.....                         | 12-2  |
| 6.4 Points to Remember for All Approaches..... | 6-32 | <b>SECTION 13: MESSAGES, ABBREVIATIONS, AND<br/>NAV TERMS</b> ..... | 13-1  |
| <b>SECTION 7: WPT PAGES</b> .....              | 7-1  | 13.1 Messages.....  | 13-1  |
| 7.1 WPT Page Group.....                        | 7-1  | 13.2 Abbreviations.....   | 13-9  |
| 7.2 Airport Location Page.....                 | 7-4  | 13.3 Navigation Terms.....  | 13-12 |
| 7.3 Airport Runway Page.....                   | 7-5  | <b>Appendix A: Data Card Use</b> .....                              | A-1   |
| 7.4 Airport Frequency Page.....                | 7-6  | <b>Appendix B: Specifications</b> .....                             | B-1   |
| 7.5 Airport Approach Page.....                 | 7-8  | <b>Appendix C: Map Datums</b> .....                                 | C-1   |
| 7.6 Airport Arrival Page.....                  | 7-11 | <b>Appendix D: Troubleshooting Q &amp; A</b> .....                  | D-1   |
| 7.7 Airport Departure Page.....                | 7-13 |   |       |
| 7.8 Intersection Page.....                     | 7-14 |   |       |
| 7.9 NDB Page.....                              | 7-15 |   |       |
| 7.10 VOR Page.....                             | 7-15 |   |       |
| 7.11 User Waypoint Page.....                   | 7-17 |   |       |



---

**WARNING:** Navigation and terrain separation must NOT be predicated upon the use of the TERRAIN function. The TERRAIN feature is NOT intended to be used as a primary reference for terrain avoidance and does not relieve the pilot from the responsibility of being aware of surroundings during flight. The TERRAIN feature is only to be used as an aid for terrain avoidance and is not certified for use in applications requiring a certified terrain awareness system. Terrain data is obtained from third party sources. Garmin is not able to independently verify the accuracy of the terrain data.

---



---

**WARNING:** The terrain data should be used only as an aid for situational awareness. Terrain data must not be used as the sole basis for decisions or maneuvers to avoid terrain or obstacles. Terrain data must not be used for navigation.

---



---

**WARNING:** The altitude calculated by GNS 430 GPS receivers is geometric height above Mean Sea Level and could vary significantly from the altitude displayed by pressure altimeters in aircraft. GPS altitude should never be used for vertical navigation. Always use pressure altitude displayed by pressure altimeters in the aircraft.

---



---

**WARNING:** The Jeppesen database used in the GNS 430 system must be updated regularly in order to ensure that its information remains current. Updates are released every 28 days. A database information packet is included in the GNS 430 package. Pilots using an outdated database do so entirely at their own risk.

---



---

**WARNING:** The basemap (land and water data) must not be used for navigation, but rather only for non-navigational situational awareness. Any basemap indication should be compared with other navigation sources.

---



---

**WARNING:** For safety reasons, GNS 430 operational procedures must be learned on the ground.

---



---

**WARNING:** The United States government operates the Global Positioning System and is solely responsible for its accuracy and maintenance. The GPS system is subject to changes which could affect the accuracy and performance of all GPS equipment. GPS accuracy may be degraded by the U.S. Department of Defense-imposed Selective Availability (SA) program. With 'SA' on, GPS altitude may be in error by several hundred feet. Portions of the Garmin GNS 430 utilize GPS as a precision electronic NAVigation AID (NAVAID). Therefore, as with all NAVAIDs, information presented by the GNS 430 can be misused or misinterpreted and, therefore, become unsafe.

---



---

**WARNING:** Use the GNS 430 at your own risk. To reduce the risk of unsafe operation, carefully review and understand all aspects of the GNS 430 Pilot's Guide documentation and the GNS 430 Flight Manual Supplement. Thoroughly practice basic operation prior to actual use. During flight operations, carefully compare indications from the GNS 430 to all available navigation sources, including the information from other NAVAIDs, visual sightings, charts, etc. For safety purposes, always resolve any discrepancies before continuing navigation.

---



---

**CAUTION:** The GNS 430 display lens is coated with a special anti-reflective coating that is very sensitive to skin oils, waxes, and abrasive cleaners. **CLEANERS CONTAINING AMMONIA WILL HARM THE ANTI-REFLECTIVE COATING.** It is very important to clean the lens using a clean, lint-free cloth and an eyeglass lens cleaner that is specified as safe for anti-reflective coatings.

---



---

**CAUTION:** The Garmin GNS 430 does not contain any user-serviceable parts. Repairs should only be made by an authorized Garmin service center. Unauthorized repairs or modifications could void both the warranty and the pilot's authority to operate this device under FAA/FCC regulations.

---



---

**NOTE:** All visual depictions contained within this document, including screen images of the GNS 430 panel and displays, are subject to change and may not reflect the most current GNS 430 system. Depictions of equipment may differ slightly from the actual equipment.

---



---

**NOTE:** This device complies with part 15 of the FCC Rules. Operation is subject to the following two conditions: (1) this device may not cause harmful interference, and (2) this device must accept any interference received, including interference that may cause undesired operation.

---



---

**NOTE:** Unless otherwise specified within this manual, the term 'GNS 430' applies to both the GNS 430 and the GNS 430A models. Please, note that the difference between these two models is indicated under 'VHF COM Performance' in the Specifications section of this manual (Appendix B).

---



---

**NOTE:** This product, its packaging, and its components contain chemicals known to the State of California to cause cancer, birth defects, or reproductive harm. This notice is being provided in accordance with California's Proposition 65. If you have any questions or would like additional information, please refer to our website at [www.garmin.com/prop65](http://www.garmin.com/prop65).

---

## LIMITED WARRANTY

This Garmin product is warranted to be free from defects in materials or workmanship for two years from the date of purchase. Within this period, Garmin will, at its sole option, repair or replace any components that fail in normal use. Such repairs or replacement will be made at no charge to the customer for parts and labor, provided that the customer shall be responsible for any transportation cost. This warranty does not cover failures due to abuse, misuse, accident, or unauthorized alterations or repairs.

THE WARRANTIES AND REMEDIES CONTAINED HEREIN ARE EXCLUSIVE AND IN LIEU OF ALL OTHER WARRANTIES EXPRESS OR IMPLIED OR STATUTORY, INCLUDING ANY LIABILITY ARISING UNDER ANY WARRANTY OF MERCHANTABILITY OR FITNESS FOR A PARTICULAR PURPOSE, STATUTORY OR OTHERWISE. THIS WARRANTY GIVES YOU SPECIFIC LEGAL RIGHTS, WHICH MAY VARY FROM STATE TO STATE.

IN NO EVENT SHALL GARMIN BE LIABLE FOR ANY INCIDENTAL, SPECIAL, INDIRECT OR CONSEQUENTIAL DAMAGES, WHETHER RESULTING FROM THE USE, MISUSE, OR INABILITY TO USE THIS PRODUCT OR FROM DEFECTS IN THE PRODUCT. Some states do not allow the exclusion of incidental or consequential damages, so the above limitations may not apply to you.

Garmin retains the exclusive right to repair or replace the unit or software, or to offer a full refund of the purchase price, at its sole discretion. SUCH REMEDY SHALL BE YOUR SOLE AND EXCLUSIVE REMEDY FOR ANY BREACH OF WARRANTY.

To obtain warranty service, contact your local Garmin Authorized Service Center. For assistance in locating a Service Center near you, visit the Garmin Web site at "<http://www.garmin.com>" or contact Garmin Customer Service at 800-800-1020.



## SECTION 1: INTRODUCTION

### 1.1 ACCESSORIES AND PACKING LIST

Congratulations on choosing the finest, most advanced panel mount IFR navigation/communication system available. The GNS 430 represents Garmin's commitment to provide accurate, easy-to-use avionics.

Before installing and getting started with the GNS 430, please check to see that the package includes the following items. If any parts are missing or damaged, please contact a Garmin dealer immediately.

#### Standard Package:

- GNS 430 Unit, NavData® Card, and Terrain Data Card
- Installation Rack, Connectors, and GPS Antenna
- Pilot's Guide and Quick Reference Guide
- 400/500 Series Display Interface Pilot's Guide Addendum
- Database Subscription Packet
- Warranty Registration Card
- GNS 430 Simulator CD-ROM

The Garmin dealer performs the installation and configuration of the GNS 430. The GNS 430 is secured in the installation rack with the proper wiring connections performed. After installation, the NavData card and the Terrain Data card (if applicable) are installed into the correct slot on the front of the unit (Appendix A). A Garmin dealer can answer questions about the installation such as location of antennas or any connections to other equipment in the panel.



---

**NOTE:** *Help Garmin provide better support by completing our on-line registration. Registration ensures notification of product updates, new products, and provides for lost or stolen unit tracking. Have the serial number of the GNS 430 available and connect to our website ([www.garmin.com](http://www.garmin.com)). Look for the product registration link on the home page.*

---

## 1.2 KEY AND KNOB FUNCTIONS

The GNS 430 is designed to make operation as simple as possible. The key and knob descriptions (Figure 1-1) provide a general overview of the primary function(s) for each key and knob. The takeoff tour (Section 1.3) is intended to provide a brief overview of the primary functions of the GNS 430.

Experiment with the unit and refer to the reference sections for more information.

Data is entered using the large and small knobs. Experiment with them to become efficient at entering data. This greatly reduces the amount of time spent operating the GNS 430 in flight.

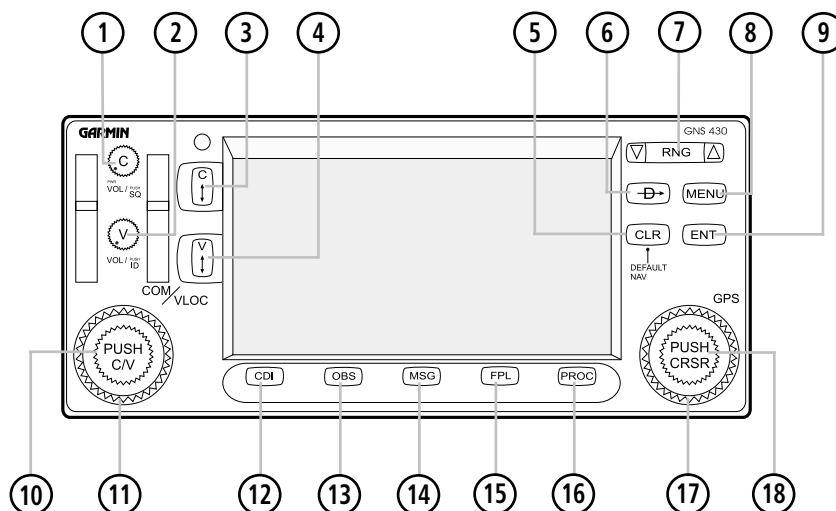

Figure 1-1 Keys and Knobs

- |   |                  |   |                 |   |                   |
|---|------------------|---|-----------------|---|-------------------|
| ① | COM Power/Volume | ⑦ | RNG (map range) | ⑬ | OBS               |
| ② | VLOC Volume      | ⑧ | MENU            | ⑭ | MSG (message)     |
| ③ | COM Flip-flop    | ⑨ | ENT (enter)     | ⑮ | FPL (flight plan) |
| ④ | VLOC Flip-flop   | ⑩ | Small left knob | ⑯ | PROC (procedures) |
| ⑤ | CLR (clear)      | ⑪ | Large left knob | ⑰ | Large right knob  |
| ⑥ | Direct-to        | ⑫ | CDI             | ⑱ | Small right knob  |

## Left-hand Keys and Knobs

The **COM Power/Volume** Knob controls unit power and communications radio volume. Press momentarily to disable automatic squelch control.

The **VLOC Volume** Knob controls audio volume for the selected VOR/Localizer frequency. Press momentarily to enable/disable the ident tone.

The large **left** knob (COM/VLOC) is used to tune the megahertz (MHz) value of the standby frequency for the communications transceiver (COM) or the VLOC receiver, whichever is currently selected by the tuning cursor.

The small **left** knob (COM/VLOC) is used to tune the kilohertz (kHz) value of the standby frequency for the communications transceiver (COM) or the VLOC receiver, whichever is currently selected by the tuning cursor. Press this knob momentarily to toggle the tuning cursor between the COM and VLOC frequency fields.

The **COM Flip-flop** Key is used to swap the active and standby COM frequencies. Press and hold to select emergency channel (121.500 MHz).

The **VLOC Flip-flop** Key is used to swap the active and standby VLOC frequencies (i.e., make the selected standby frequency active).

## Right-hand Keys and Knobs

The **RNG** Key allows the pilot to select the desired map range. Use the up arrow to zoom out to a larger area, or the down arrow to zoom in to a smaller area.

The **Direct-to** Key provides access to the direct-to function, which allows the pilot to enter a destination waypoint and establishes a direct course to the selected destination (Section 4).

The **MENU** Key displays a context-sensitive list of options. This options list allows the pilot to access additional features or make settings changes which relate to the currently displayed page.

The **CLR** Key is used to erase information, remove map detail, or to cancel an entry. Press and hold the **CLR** key to immediately display the Default NAV Page.

The **ENT** Key is used to approve an operation or complete data entry. It is also used to confirm information, such as during power on.

The large **right** knob is used to select between the various page groups: NAV, WPT, AUX, or NRST. With the on-screen cursor enabled, the large **right** knob allows the pilot to move the cursor about the page. The large **right** knob is also used to move the target pointer right (turn clockwise) or left (counterclockwise) when the map panning function is active.

The small **right** knob is used to select between the various pages within one of the groups listed above. Press this knob momentarily to display the on-screen cursor. The cursor allows the pilot to enter data and/or make a selection from a list of options. When entering data, the small knob is used to select the desired letter or number and the large knob is used to move to the next character space. The small **right** knob is also used to move the target pointer up (turn clockwise) or down (counterclockwise) when the map panning function is active.



*NOTE: When the GNS 430 is displaying a list of information that is too long for the display screen, a scroll bar appears along the right-hand side of the display (Figure 1-2). The scroll bar graphically indicates the number of additional items available within the selected category. To scroll through the list, press the small **right** knob to activate the cursor, then turn the large **right** knob.*

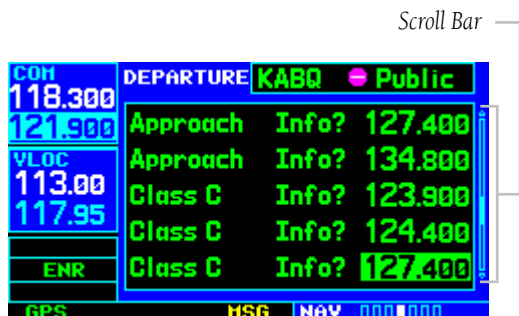

Figure 1-2 Scroll Bar

## Bottom Row Keys

The **CDI** Key is used to toggle which navigation source (GPS or VLOC) provides output to an external HSI or CDI.

The **OBS** Key is used to select manual or automatic sequencing of waypoints. Pressing the **OBS** Key selects OBS mode, which retains the current ‘active to’ waypoint as the navigation reference even after passing the waypoint (i.e., prevents sequencing to the next waypoint). Pressing the **OBS** Key again returns the unit to normal operation, with automatic sequencing of waypoints. When OBS mode is selected, the pilot may set the desired course to/from a waypoint using the ‘Select OBS Course’ pop-up window, or an external OBS selector on the HSI or CDI.

The **MSG** Key is used to view system messages and to alert the pilot to important warnings and requirements. See Section 13.1 for more information on messages.

The **FPL** Key allows the pilot to create, edit, activate, and invert flight plans, as well as access approaches, departures, and arrivals. A closest point to flight plan feature is also available from the **FPL** Key. See Section 5 for more information on flight plans.

The **PROC** Key allows the pilot to select and remove approaches, departures, and arrivals from the flight plan. When using a flight plan, available procedures for the departure and/or arrival airport are offered automatically. Otherwise, the pilot may select the desired airport, then the desired procedure.

## 1.3 TAKEOFF TOUR

### Overview

The Garmin GNS 430 provides the pilot accurate navigational data and communication capability, along with non-precision and precision approach certification in the IFR environment. The takeoff tour is designed to familiarize the pilot with the operation of the GNS 430 by :

- Powering up the unit
- Changing frequencies
- Entering data
- Performing a simple direct-to
- Selecting IFR procedures
- Using some limited flight plans

In addition, this section briefly covers the Default NAV Page, the Map Page, and the NAV/COM Page, which are available as part of the NAV Page Group. These pages are used for most of the in-flight navigation.

The takeoff tour assumes that the unit and antennas have been properly installed and that the GNS 430's default settings have not been changed. If any of the factory default settings (position format, units of measure, selectable fields, etc.) have been changed, the pictures shown here may not exactly match what is shown on the GNS 430. Prior to using the GNS 430 for the first time, Garmin recommends that the aircraft be moved to a location that is well away from buildings and other aircraft so the unit can collect satellite data without interruption.

This takeoff tour is intended to provide a brief introduction of the GNS 430's major features. Sections 2 through 13 of this manual describe these features, and others, in additional detail. Refer to these sections, as needed, to learn or review the details regarding a particular feature.

After becoming familiar with the basics, some suggested reading within this Pilot's Guide includes:

- Flight plan features - Section 5
- Waypoint information pages (database information) - Section 7
- IFR procedures - Section 6
- Unit settings (configuring the unit to the pilot's preferences) - Section 10

If more information is needed, Garmin's Customer Service staff is available during normal business hours (U.S. Central time zone) at the phone and fax numbers listed on page ii. Garmin can also be reached by mail (page ii) or at our web site address, [www.garmin.com](http://www.garmin.com).

### Powering up the GNS 430

The GNS 430's power and COM volume are controlled using the **COM Power/Volume** knob at the top left corner of the unit. Turning it clockwise turns unit power on and increases the COM radio volume. After turning the unit on, a welcome page (Figure 1-3) is displayed while the unit performs a self test, followed sequentially by the Land Data Page, then (if configured for TERRAIN) the Terrain Data Page, the Obstacle Data Page, and the Airport Terrain Data Page.



Figure 1-3 Welcome Page

The Database Confirmation Page (Figure 1-4) appears next, which shows the current database information on the NavData card (with the valid operating dates, cycle number, and database type indicated). The database is updated every 28 days, and must be current for approved instrument approach operations. Information on database subscriptions is available inside the GNS 430 package.



Figure 1-4 Database Confirmation Page

### To acknowledge the database information:

Press the **ENT** Key.

Once the database has been acknowledged, the Instrument Panel Self-test Page appears (Figure 1-5).



Figure 1-5 Instrument Panel Self-Test Page

### Instrument Panel Self-test Page

To ensure that the GNS 430 and any connected instruments are working properly, check for the following indications on the CDI/HSI, RMI, external annunciators, and other connected instruments:

- Course deviation - Half left/no flag
- TO/FROM flag - TO
- Bearing to destination - 135°
- Distance to dest. - 10.0 nautical mile (nm)
- All external annunciators (if installed) - On
- Glideslope - Half up/no flag
- Time to destination - 4 minutes
- Desired track - 149.5°
- Ground speed - 150 knots

The Instrument Panel Self-test Page (Figure 1-5) indicates the currently selected OBS course, fuel capacity (CAP), fuel on board (FOB), and fuel flow (FF). The fuel capacity, fuel on board, and fuel flow may be manually entered if the installation does not include connection to sensors which automatically provide these figures.

### To enter fuel capacity, fuel on board or fuel flow figures (if not provided by sensors):

- 1) Turn the large **right** knob to select the 'CAP', 'FOB', or 'FF' field.

- 2) Turn the small and large **right** knobs to enter the desired figure (Figures 1-5 and 1-6) and press the **ENT** Key.

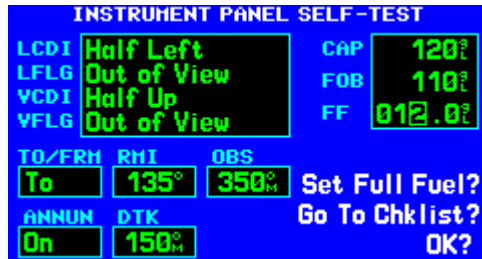

Figure 1-6 Fuel Flow Selected

The Instrument Panel Self-test Page includes selections to set fuel on board (FOB) to full capacity and access the Checklists Page. This allows the pilot to quickly set fuel to full limits and display any checklists that have been entered, such as start up or takeoff checklists.

**To set fuel on board to full (if not provided by sensor):**

- 1) Turn the large **right** knob to highlight 'Set Full Fuel?' (Figure 1-7).

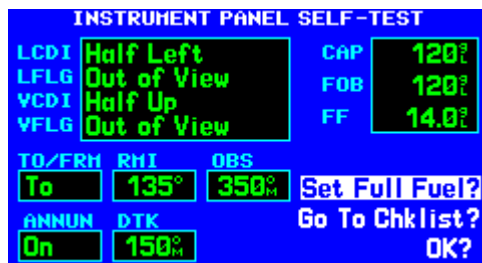

Figure 1-7 'Set Full Fuel?' Highlighted

- 2) Press the **ENT** Key and verify that fuel on board ('FOB') now matches the fuel capacity (CAP) figure. Fuel on board is reduced, over time, based on the fuel flow (FF) figure.

**To view the Checklists Page:**

- 1) Turn the large **right** knob to highlight 'Go To Chklist?' (Figure 1-8) and press the **ENT** Key.

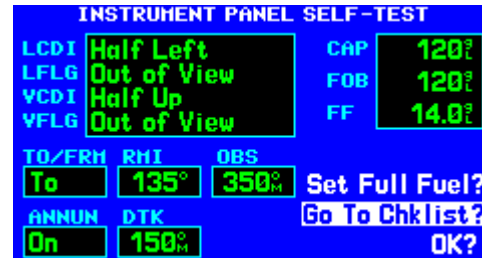

Figure 1-8 'Go To Chklist?' Highlighted

- 2) Turn the large **right** knob to select the desired checklist, then execute each step (Section 10.3, Utility Page: Checklists) in the selected checklist.
- 3) Once the pilot completes the desired checklist(s), press the small **right** knob to return to the Checklists Page. Press the small **right** knob again to return to normal operation on the Satellite Status Page or the Map Page.
- 4) Once instrument operation has been verified with the Instrument Panel Self-test Page displayed, press the **ENT** Key.



*NOTE: The GNS 430 can hold up to nine checklists with up to 30 entries in each checklist.*

## Satellite Status Page

The Satellite Status Page (Figure 1-9) appears as the GNS 430 attempts to collect satellite information.

When an ‘Acquiring’ status is displayed on the Satellite Status Page, the signal strengths of any satellites received appear as ‘bar graph’ readings. This is a good indication that the unit is receiving signals and a position fix is being determined. Following the first-time use of the GNS 430, the time required for a position fix varies, usually from one to two minutes.

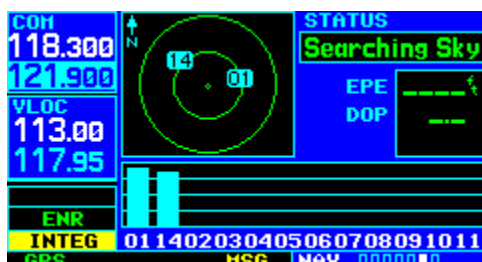

Figure 1-9 Satellite Status Page

If the unit can only obtain enough satellites for 2D navigation (no altitude), the unit uses the altitude provided by the altitude encoder (if one is connected).

The ‘INTEG’ annunciator (bottom left corner of the screen) indicates that satellite coverage is insufficient to pass built-in integrity monitoring tests. In the example above, not enough satellites are being received to determine a position. The Satellite Status Page shows the ID numbers for the satellites and the relative signal strength of each satellite received (as a ‘bar graph’ reading).

‘Searching Sky’ indicates that satellite almanac data is not available or has expired (if the unit hasn’t been used for six months or more). This means the unit is acquiring satellite data to establish almanac and satellite orbit information, which can take five to ten minutes. The data is recollected from the first available satellite. The Satellite Status Page displays a ‘Search Sky’ status, and the message

annunciator (MSG), above the **MSG** Key also flashes to alert the pilot of system message, ‘Searching the Sky’.

### To view a system message:

Press the **MSG** Key (Figure 1-10).

The Message Page appears and displays the status or warning information applicable to the receiver’s current operating condition.



Figure 1-10 Message Page

### To return to the previous page after viewing a message:

Press the **MSG** Key again.



**NOTE:** The GNS 430 utilizes certain software algorithms to ensure reliable GPS receiver operation. Receiver Autonomous Integrity Monitoring (RAIM) and Fault Detection and Exclusion (FDE) are two examples. These features allow navigation during Oceanic/Remote legs of a flight using the GNS 430. For further details, please refer to Sections 10.3 and 12.



## Selecting COM and VLOC Frequencies

While the GNS 430 is acquiring a position, take a minute to dial in the active and standby frequencies to be used for the first phase of the flight. The GNS 430's display is divided into separate 'windows' (or screen areas), including a COM Window, VLOC Window, and the GPS Window (Figure 1-11).

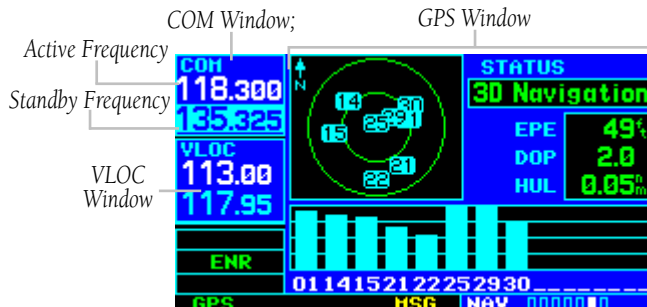

Figure 1-11 Standby Frequency 135.325 MHz

Pressing the small **left** knob activates the tuning cursor in the desired frequency window. To select the active frequency, first enter the frequency in the standby field, and use the **COM Flip-flop** (or the **NAV Flip-flop**) Key to move it to the active field.

### To change the standby communication frequency:

- 1) Press the small **left** knob if needed, to move the tuning cursor to the COM Window (Figure 1-11).
- 2) Turn the large **left** knob to select the MHz, and the small **left** knob to select the kHz of the desired frequency.

### To place the standby communication frequency in the active field:

Press the **COM Flip-flop Key** (Figure 1-12).

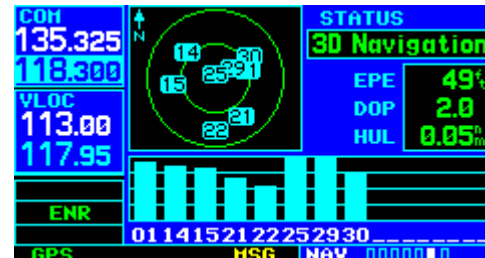

Figure 1-12 Active Frequency 135.325 MHz

Once the active frequency has been entered, repeat steps 1 and 2 to enter the standby frequency. After both communication frequencies have been entered, the COM Window may be kept 'hot' by leaving the cursor on the standby frequency. Move the cursor to the VLOC Window by pressing the small **left** knob.



**NOTE:** When selecting VLOC frequencies, the tuning cursor automatically returns to the COM Window after 30 seconds of inactivity.

### To change the standby VLOC frequency:

- 1) Press the small **left** knob if needed, to activate the tuning cursor in the VLOC Window.
- 2) Turn the large **left** knob to select the MHz, and the small **left** knob to select the kHz of the desired frequency.

### To place the standby frequency in the active field:

Press the **NAV Flip-flop Key**.

## Page Groups

| Page Groups   |               |                |               |
|---------------|---------------|----------------|---------------|
| NAV Group     | WPT Group     | AUX Group      | NRST Group    |
| see Section 3 | see Section 7 | see Section 10 | see Section 8 |

Table 1-1 Page Groups

The bottom right corner of the screen (Figure 1-13) indicates which page group (Table 1-1) is currently being displayed, the number of pages available within that group (indicated by square icons), and the placement of the current page within that group (indicated by a highlighted square icon).

In addition to the NAV Page Group, additional page groups are available for waypoint information (WPT), auxiliary (AUX) functions such as flight planning or unit settings, and listings for nearest (NRST) airports or other facilities.



Figure 1-13 Current Page and Page Group

### To select the desired page group:

Turn the large **right** knob until a page from the desired page group is displayed (Figure 1-13).

### To select the desired page within the page group:

Turn the small **right** knob until the desired page is displayed (Figure 1-13).

## NAV Pages

There are seven pages available under the NAV Page Group\*:

- Default NAV Page
- Map Page
- TERRAIN Page
- NAV/COM Page
- Position Page
- Satellite Status Page
- Vertical Navigation Page

The Default NAV Page, the Map Page, and the NAV/COM Page are used for most of the in-flight navigation.



**NOTE:** \*Eight NAV pages are available when the GNS 430 installation includes connection to traffic and/or weather information sources. See the 400/500 Series Display Interfaces Pilot's Guide Addendum, p/n 190-00140-10, or the 400/500 Series Garmin Optional Displays Pilot's Guide Addendum, p/n 190-00140-13.

### To select the NAV Page Group and display the Default NAV Page:

Press and hold the **CLR** Key.

### To select the desired NAV Page:

Turn the small **right** knob until the desired page is displayed.

## Map Page

After the GNS 430 acquires satellites and computes a position, the Map Page (Figure 1-14) appears automatically.

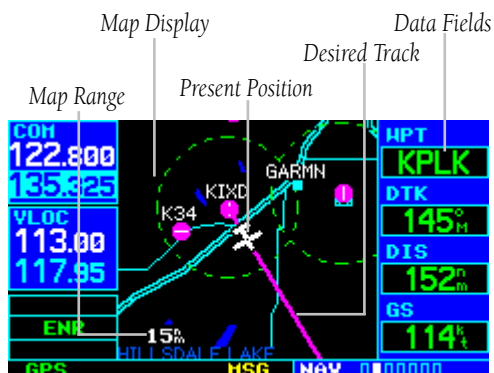

Figure 1-14 Map Page

The Map Page displays the present position (using an airplane symbol) relative to nearby airports, VORs, NDBs, intersections, user waypoints, and airspace boundaries. The route is displayed as a solid line.

Data fields for destination waypoint (WPT), distance to waypoint (DIS), desired track (DTK), and ground speed (GS) appear on the right-hand side of the display. These fields are user selectable (Section 3.4, Selecting Desired On-screen Data) to allow the pilot to configure the unit. Available settings include: altitude, bearing, enroute safe altitude, estimated time of arrival, minimum safe altitude, and ground track.

A Map Setup Page is provided to designate the maximum range at which each map feature appears. These settings provide an automatic decluttering of the map (based upon preferences) while adjusting the range. See Section 13.3 for definitions of these navigation terms.

While viewing the Map Page, the pilot can quickly declutter and remove many of the background map details by pressing the **CLR** Key (repeatedly) until the desired detail is depicted.

To change the map range, press the up arrow (to zoom out) or the down arrow (to zoom in) of the **RNG** (map range) Key. The current map range is depicted in the lower left corner of the Map Display.

## Direct-to Navigation

The GNS 430 can use direct point-to-point navigation to provide guidance from takeoff to touchdown, even in the IFR environment. Once a destination is selected, the unit provides speed, course, and distance data based upon a direct course from the present position to the destination. A destination can be selected from any page with the **Direct-to** Key.

### To select a direct-to destination:

- 1) Press the **Direct-to** Key. The Select Direct-to Waypoint Page appears with the destination field highlighted.
- 2) Turn the small **right** knob to enter the first letter of the destination waypoint identifier. The destination waypoint may be an airport, VOR, NDB, intersection, or user waypoint, as long as it is in the database or stored in memory as a user waypoint.
- 3) Turn the large **right** knob to the right to move the cursor to the next character position.
- 4) Repeat steps 2 and 3 to spell out the rest of the waypoint identifier (Figure 1-15).



Figure 1-15 Direct-to Waypoint Page

- 5) Press the **ENT** Key to confirm the identifier. The 'Activate?' function field is highlighted (Figure 1-16).



Figure 1-16 'Activate?' Highlighted

- 6) Press the **ENT** Key to activate a direct-to course to the selected destination.

Once a direct-to destination is selected, press and hold the **CLR** Key to display the Default NAV Page.

## Default NAV Page

During most flights, the Default NAV Page, the Map Page, and the NAV/COM Page are the primary pages used for navigation.

### To select the Default NAV Page:

Press and hold the **CLR** Key (Figure 1-17).

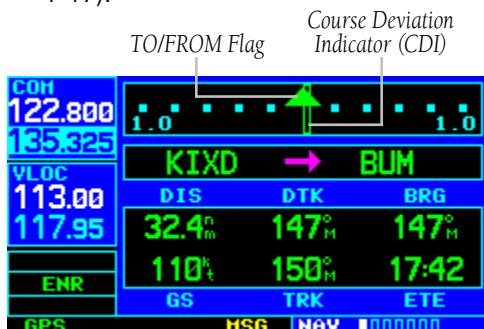

Figure 1-17 Default NAV Page

The Default NAV Page (Figure 1-17) displays a graphic course deviation indicator (CDI), the active leg of the flight plan (as defined by the current 'from' and 'to' waypoints), and six user-selectable data fields. The default settings for these fields are distance to waypoint (DIS), desired track (DTK), bearing to waypoint (BRG), ground speed (GS), ground track (TRK), and estimated time enroute (ETE). See Section 13.3 for definitions of these navigation terms.

### To change the data fields:

- 1) From the Default NAV page, press the **MENU** Key and select 'Change Fields?' (Figure 1-18).



Figure 1-18 Default NAV Page Menu

- 2) Turn the large **right** knob to select the data field to be changed.
- 3) Turn the small **right** knob to display a list of data options (Figure 1-19).



Figure 1-19 'Select Field Type' Window

- 4) Press the **ENT** Key to select the desired data item and return to the Default NAV Page.

## NAV/COM Page

From the Default NAV Page, turn the small **right** knob until the NAV/COM Page (Figure 1-20) is displayed.

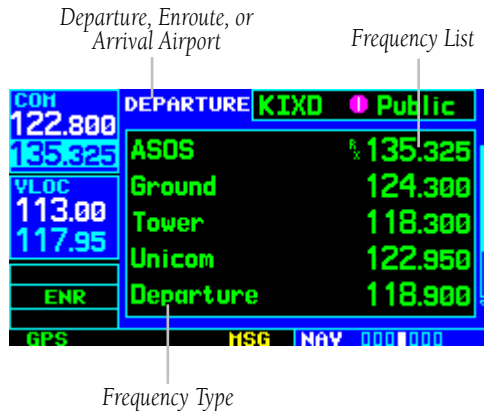

Figure 1-20 NAV/COM Page

The NAV/COM Page displays the available frequencies (communications and navigation) for the departure airport, any enroute airports which are included in the flight plan, and the final destination airport. When using the direct-to function, frequencies are listed for the airport nearest to the starting position and the destination airport.

### To display the frequency list for the desired flight plan or direct-to airport:

- 1) Press the small **right** knob to activate the cursor on the airport identifier field (in the GPS Window).
- 2) Turn the small **right** knob to display the list of airports (departure, arrival, and enroute) for the flight plan or direct-to. Continue to turn the small **right** knob until the desired airport is selected.
- 3) Press the **ENT** Key to display the frequency list for the selected airport.

A frequency listed on the NAV/COM Page can be quickly transferred to the standby field of the COM Window or the VLOC Window. This time-saving process prevents having to 're-key' a frequency already displayed elsewhere on the screen.

### To select a communication or navigation frequency:

- 1) Press the small **right** knob to activate the cursor in the GPS Window.
- 2) Turn the large **right** knob to select the desired frequency from the list.
- 3) Press the **ENT** Key to transfer the selected frequency to the standby field in the COM or VLOC Window. COM frequencies automatically go to the standby field of the COM Window and navigation frequencies automatically go to the standby field of the VLOC Window, regardless of which window is currently highlighted by the cursor.
- 4) To activate the selected frequency, press the **COM** or **VLOC Flip-flop** Key.

To display frequencies for a different airport along the flight plan.

- 1) Press the small **right** knob to highlight the airport identifier field.
- 2) Turn the small **right** knob to display the list of airports within the flight plan (Figure 1-21).



Figure 1-21 Airport Window

- 3) Continue turning the small **right** knob to select the desired airport and press the **ENT** Key.

## IFR Procedures

Once the direct-to or flight plan is confirmed, the whole range of instrument procedures is available. Departures (SIDs), arrivals (STARs), non-precision and precision approaches are stored within the NavData card and are available using the **PROC** (procedures) Key.

To display the Procedures Page (Figure 1-22), press the **PROC** Key.

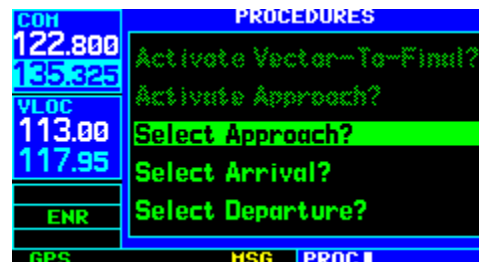

Figure 1-22 Procedures Page

The steps required to select and activate an approach, departure, or arrival are identical. In this introductory section, there are examples of the steps required to select an approach, but keep in mind the same process also applies to departures and arrivals.

### To select an approach, departure, or arrival:

- 1) Turn the large **right** knob to select the desired option ('Select Approach?', 'Select Arrival?', or 'Select Departure?') from the Procedures Page.
- 2) Press the **ENT** Key to display a list of available procedures for the arrival (when using approaches or STARs) or departure (when using SIDs) airport.
- 3) Turn the small **right** knob to select the desired procedure and press the **ENT** Key.

- 4) For approaches, a window appears (Figure 1-23) to select the desired initial approach fix (IAF) or provide a 'vectors' option to select just the final course segment of the approach. Turn the small **right** knob to select the desired option and press the **ENT** Key. (The 'vectors' option extends the final inbound course beyond the final approach fix, allowing the pilot to intercept the final course segment beyond its normal limits.)

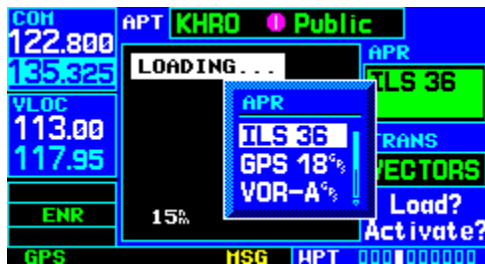

Figure 1-23 Approach Window

- 5) For departures and arrivals, a window appears to select the desired transition. Turn the small **right** knob to select the desired option and press the **ENT** Key.

In the flight plan or direct-to, the departure or arrival airport is replaced with the sequence of waypoints contained within the selected procedure.

## Nearest (NRST) Pages

The NRST Page Group provides detailed information on the nine nearest airports, VORs, NDBs, intersections, and user-created waypoints within 200 nm of the current position. In addition, pages are also provided to display the five nearest center (ARTCC/FIR) and Flight Service Station (FSS) points of communication, plus alert the pilot to any nearby special-use or controlled airspaces.

The Nearest Airport Page (Figure 1-24) is one of eight pages available in the NRST group:

- Nearest Airport Page
- Nearest NDB Page
- Nearest User Waypoints Page
- Nearest FSS Page
- Nearest Intersection Page
- Nearest VOR Page
- Nearest ARTCC Page
- Nearest Airspace Page

The communication frequencies and runway information may both be examined directly from the Nearest Airport Page. As discussed earlier for the NAV/COM Page, the pilot may also place any displayed frequency into the standby COM or VLOC field by highlighting the frequency with the cursor and pressing the **ENT** Key.

## To display the NRST pages:

- 1) If necessary, press and hold the **CLR** Key to select the NAV group and display the Default NAV Page.
- 2) Turn the large **right** knob to select the NRST Page Group, as indicated by 'NRST' appearing in the lower right corner of the screen.
- 3) Turn the small **right** knob to select the desired NRST Page.

## To display a list of nearby airports:

- 1) Turn the large **right** knob to select the NRST Page Group and (if needed) the small **right** knob to select the Nearest Airport Page (Figure 1-24).



Figure 1-24 Nearest Airport Page

- 2) To scroll through the list, press the small **right** knob, then turn the large **right** knob (Figure 1-25)



Figure 1-25 Scrolling the Nearest Airport List

## To view additional information for a nearby airport:

- 1) Press the small **right** knob to activate the cursor.
- 2) Turn the large **right** knob to select the desired airport from the list.
- 3) Press the **ENT** Key to display waypoint (WPT) information pages for the selected airport (Figure 1-26).

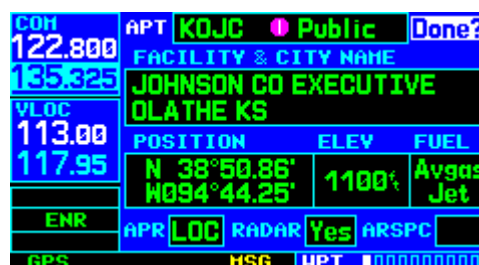

Figure 1-26 Airport Location Page

- 4) To display runway and frequency information, press the small **right** knob to remove the cursor and turn the small **right** knob to display the desired information page.

The Nearest Airport Page may be used in conjunction with the **Direct-to** Key to quickly set a course to a nearby facility in an in-flight emergency. Selecting a nearby airport as a direct-to destination overrides the flight plan or cancels a previously selected direct-to destination. (The pilot still has the option of returning to the flight plan by cancelling the direct-to; see Section 4.1, Cancelling Direct-to Navigation.)



**To select a nearby airport as a direct-to destination from the Nearest Airport Page:**

- 1) From the Nearest Airport Page, press the small **right** knob to activate the cursor.
- 2) Turn the large **right** knob to select the desired airport from the list.
- 3) Press the **Direct-to** Key, the **ENT** Key, and the **ENT** Key (again) to navigate to the nearby airport.

**To select a nearby airport as a direct-to destination from the Airport Information Page:**

- 1) Press the **Direct-to Key**, then press the **ENT** Key (Figure 1-27).

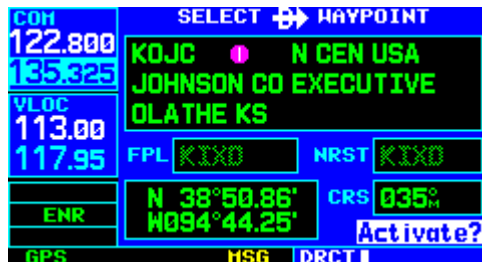

Figure 1-27 'Activate?' Highlighted

- 2) Press the **ENT** Key again to navigate to the nearby airport.

**Nearest (NRST) Airspace Page**

The last page in the NRST group, the Nearest Airspace Page (Figure 1-28), provides information for up to nine controlled or special-use airspaces near or in the flight path. Airspace information appears on this page based upon the same criteria used for airspace alert messages. Nearby airspace information and airspace alert messages are provided according to the following conditions:

- If the projected course will take the aircraft inside an airspace within the next ten minutes, the message 'Airspace ahead -- less than 10 minutes' appears.
- If the aircraft is within two nautical miles of an airspace and the current course will take it inside of the airspace, the message 'Airspace near and ahead' appears.
- If the aircraft is within two nautical miles of an airspace and the current course will not take it inside of the airspace, the message 'Near airspace less than 2nm' appears.
- If the aircraft has entered an airspace, the message 'Inside airspace' appears.

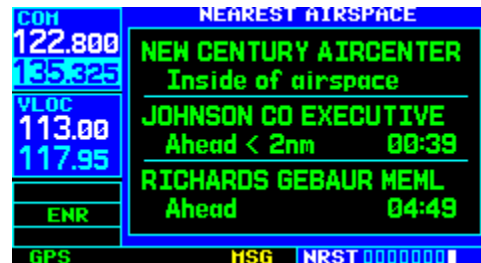

Figure 1-28 Nearest Airspace Page

By default, airspace alert messages are turned off. When turned on, the message (MSG) annunciator located directly above the **MSG** Key flashes to alert the pilot to the airspace message. See Section 10.4, Setup 1 Page: Airspace Alarms for information on enabling airspace alert messages.

### To view an airspace alert message:

- 1) Press the **MSG** Key. The Messages Page appears with the alert message (Figure 1-29).



Figure 1-29 Messages Page

- 2) Press the **MSG** Key again to return to the previous display.

Note that the airspace alerts are based upon three-dimensional data (latitude, longitude, and altitude) to avoid nuisance alerts. The alert boundaries for controlled airspace are also sectorized to provide complete information on any nearby airspace. Additional information about a nearby airspace—such as controlling agency, frequency, and floor/ceiling limits—is available from the Nearest Airspace Page (Section 8.9).

### To view additional airspace information:

- 1) Press the small **right** knob to activate the cursor.
- 2) Turn the large **right** knob to select the desired airspace from the list.
- 3) Press the **ENT** Key to view the airspace information.

## Flight Plans (FPL)

The GNS 430 lets the pilot create up to 20 flight plans with up to 31 waypoints in each flight plan. Flight plans are created, edited, and activated using the **FPL** Key. The FPL Page Group includes two pages: the Active Flight Plan Page and the Flight Plan Catalog Page (Figures 1-30 and 1-31). The Active Flight Plan Page provides information and editing features for the flight plan currently in use (referred to as ‘flight plan 00’). The Flight Plan Catalog Page serves as the main page for creating new flight plans, as well as editing or activating previously created flight plans.

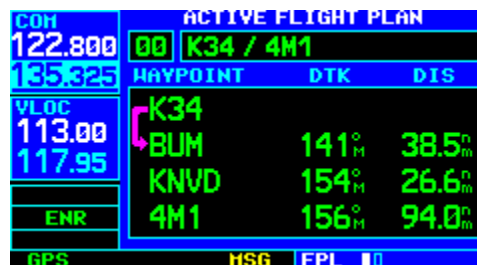

Figure 1-30 Active Flight Plan Page



Figure 1-31 Flight Plan Catalog Page

Since using flight plans is arguably one of the more complex features of the GNS 430, it will be discussed only briefly here, with focus on creating a new flight plan and activating it to use for navigation. Answers to additional questions about flight plans not found in this brief introduction can be found in Section 5, Flight Plans.

**To create a new flight plan:**

- 1) Press the **FPL** Key.
- 2) Turn the small **right** knob to select the Flight Plan Catalog Page.
- 3) Press the **MENU** Key to display the Flight Plan Catalog Page Menu (Figure 1-32).

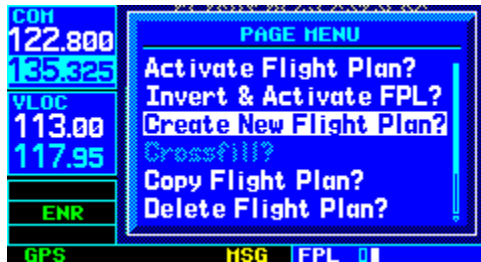

Figure 1-32 Flight Plan Catalog Page Menu

- 4) Turn the large **right** knob to select 'Create New Flight Plan?' and press the **ENT** Key.
- 5) The cursor appears on the first waypoint identifier field (located directly below 'WAYPOINT'). Use the large and small **right** knobs to enter the identifier of the first waypoint in the flight plan. (The small knob is used to select the desired letter or number and the large knob is used to move to the next character space.)
- 6) Press the **ENT** Key once the identifier has been selected. The cursor moves to the next blank waypoint identifier field.

- 7) Repeat steps 5 and 6, above, until all waypoints for the flight plan have been entered (Figure 1-33).



Figure 1-33 Enter Flight Plan Waypoints

Once the flight plan is created, it may be activated from the Flight Plan Catalog Page Menu. Activating the flight plan places it into 'flight plan 00' (a copy of it still resides in the original catalog location) and replaces any flight plan which currently exists in 'flight plan 00'.

**To activate the new flight plan:**

- 1) Press the **MENU** Key to display the Flight Plan Catalog Page Menu.
- 2) Turn the small **right** knob to select 'Activate Flight Plan?' (Figure 1-34) and press the **ENT** Key



Figure 1-34 Flight Plan Catalog Page Menu

Blank Page

## SECTION 2: COM

### 2.1 COMMUNICATING USING THE GNS 430

The GNS 430 features a digitally-tuned VHF COM radio that provides a seamless transition from communication to navigation, bringing the two most important functions in flying together in one panel-mounted unit. The GNS 430's COM radio operates in the aviation voice band, from 118.000 to 136.975 MHz, in 25 kHz steps (default). For European operations, a COM radio configuration to allow for 8.33 kHz steps is also provided (Section 10.5, Setup 2 Page: COM Configuration).

#### Volume

COM radio volume is adjusted using the **COM Power/Volume Knob**. Turn the **COM Power/Volume Knob** clockwise to increase volume, or counterclockwise to decrease volume.

#### Squelch

The COM radio features an automatic squelch, providing maximum sensitivity to weaker signals while rejecting many localized noise sources. The pilot may wish to override this automatic squelch function when listening to a distant station or when setting the desired volume level. The **COM Power/Volume Knob** allows the pilot to disable the automatic squelch and keep the COM audio open continuously. To override the automatic squelch, press the **COM Power/Volume Knob** momentarily. Press the **COM Power/Volume Knob** again to return to automatic squelch operation.

### COM Window and Tuning

Communication frequencies are selected with the tuning cursor in the standby COM frequency field (Figure 2-1), using the small and large **left** knobs to dial in the desired frequency. The standby frequency always appears below the active frequency. The active frequency is the frequency currently in use for transmit and receive operations.



Figure 2-1 'RX' Receive Indication

A frequency may also be quickly selected from the database by simply highlighting the desired frequency on any of the main pages and pressing the **ENT** Key. This process is referred to as auto-tuning. Once a frequency is selected in the standby field, it may be transferred to the active frequency by pressing the **COM Flip-flop Key**.

While receiving a station, an 'RX' indication (Figure 2-1) appears in the upper right corner of the COM Window to the immediate right of 'COM'. A 'TX' indication appears at this location when transmitting (Figure 2-2).

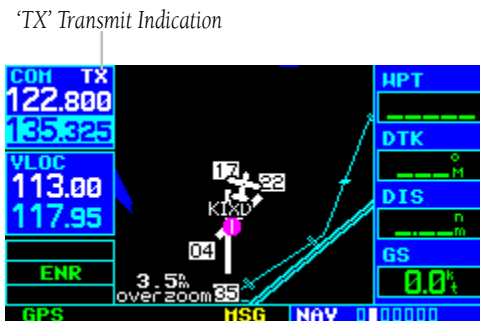

Figure 2-2 'TX' Transmit Indication



*NOTE: The tuning cursor normally appears in the COM Window, unless placed in the VLOC Window by pressing the small **left** knob. When the tuning cursor is in the VLOC Window, it automatically returns to the COM Window after 30 seconds of inactivity.*

**To select a COM frequency:**

- 1) If the tuning cursor is not currently in the COM Window, press the small **left** knob momentarily (Figure 2-3).



Figure 2-3 Standby Frequency of 135.325

- 2) Turn the large **left** knob to select the desired megahertz (MHz) value. For example, the '135' portion of the frequency '135.325'.
- 3) Turn the small **left** knob to select the desired kilohertz (kHz) value. For example, the '.325' portion of the frequency '135.325'.



*NOTE: The active frequency in either window cannot be accessed directly, only the standby frequency is highlighted by the tuning cursor.*

- 4) To make the standby frequency the active frequency, press the **COM Flip-flop** Key (Figure 2-4).



Figure 2-4 Active Frequency of 135.325

The tuning cursor is normally in the COM Window. To select a VOR/Localizer/ILS frequency, press the small **left** knob momentarily to place the cursor in the VLOC Window. Additional instructions for VOR/Localizer/ILS operations are available in Sections 6 and 9.

## Auto-Tuning

The GNS 430's auto-tune feature allows the pilot to quickly select any database frequency in the GPS Window as the standby frequency. Any COM frequency displayed in the GPS Window can be transferred to the standby COM frequency field, with a minimum of keystrokes required. The following are some examples of selecting COM frequencies from some of the main GPS pages.

### To select a COM frequency for a nearby airport:

- 1) Turn the large **right** knob to select the NRST Page Group.
- 2) Turn the small **right** knob to display the Nearest Airport Page (Figure 2-5)



Figure 2-5 Nearest Airport Page

- 3) Press the small **right** knob momentarily to place the cursor on the airport identifier field of the first airport in the list. To select another airport, turn the large **right** knob to highlight the desired airport.
- 4) The Nearest Airport Page displays the common traffic advisory frequency (CTAF) for each listed airport. To select this frequency, turn the large **right** knob to highlight the desired airport's CTAF frequency and press the **ENT** Key to place the frequency in the standby field of the COM Window.

### To display the entire list of frequencies for a nearby airport and select from that list:

- 1) Start with the desired airport highlighted on the Nearest Airport Page (as described in the preceding step 3), then press the **ENT** Key.
- 2) Press the small **right** knob momentarily to remove the cursor and turn the small **right** knob to display the frequency list (Figure 2-6).

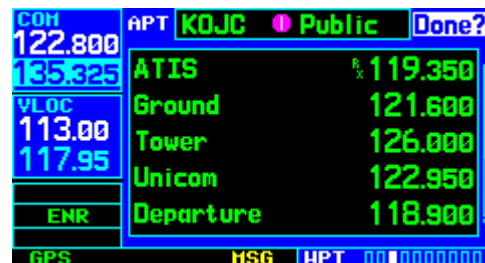

Figure 2-6 Airport Frequencies Page

- 3) Press the small **right** knob momentarily to reactivate the cursor and turn the large **right** knob to highlight the desired frequency.
- 4) Press the **ENT** Key to place the highlighted frequency in the standby COM field.

**To select a COM frequency for a nearby flight service station (FSS) or center (ARTCC):**

- 1) Turn the large **right** knob to select the NRST Page Group.
- 2) Turn the small **right** knob to select the Nearest Center or Nearest Flight Service Page (Figure 2-7).



Figure 2-7 Nearest ARTCC Page

- 3) Press the small **right** knob momentarily to place the cursor on the page.
- 4) Turn the large **right** knob to highlight the FSS/ARTCC frequency.
- 5) Press the **ENT** Key to place the frequency in the standby field of the COM Window.

**To select a COM frequency for any airport in the flight plan:**

- 1) Select the NAV/COM Page from the NAV Page Group. (Section 3.1, or press and hold the **CLR** Key, then turn the small **right** knob until the NAV/COM Page appears.)
- 2) Press the small **right** knob to place the cursor on the airport identifier field. To the left of this field appears Departure, Enroute, or Arrival, depending on the placement of the displayed airport within the flight plan.
- 3) Turn the small **right** knob to display a window (Figure 2-8) listing the airports in the flight plan. Continue turning the small **right** knob to select the desired airport.



Figure 2-8 NAV/COM Page 'Airport' Window

- 4) Press the **ENT** Key to return to the NAV/COM Page with the frequencies for the selected airport.
- 5) Turn the large **right** knob to highlight the desired frequency.
- 6) Press the **ENT** Key to place the highlighted frequency in the standby COM Window field.



To select a COM frequency for any airport in the database:

- 1) Turn the large **right** knob to select the NRST Page Group.
- 2) Turn the small **right** knob to select the Airport Frequencies Page (Figure 2-9).



Figure 2-9 Airport Frequencies Page

- 3) Press the small **right** knob to place the cursor on the airport identifier field.
- 4) Use the small and large **right** knobs to enter the identifier of the desired airport. Press the **ENT** Key when finished.
- 5) Turn the large **right** knob to highlight the desired frequency.
- 6) Press the **ENT** Key to place the highlighted frequency in the standby COM Window field.

## Emergency Channel

The GNS 430's emergency channel select provides a quick method of selecting 121.500 MHz as the active frequency in the event of an in-flight emergency. Emergency channel select is available anytime the unit is on, regardless of GPS or cursor status, or loss of the display.

### To quickly tune and activate 121.500:

Press and hold the **COM Flip-flop** Key for approximately two seconds (Figure 2-10).



Figure 2-10 Emergency Channel Active

## Stuck Microphone

As mentioned previously in this section, when the GNS 430 is transmitting, a 'TX' indication appears in the COM Window. If the microphone key is stuck or accidentally left in the on position; or the microphone continues to transmit after the key is released, the COM transmitter automatically times out (ceases transmitting) after 35 seconds of continuous broadcasting. A 'COM push-to-talk key stuck' message (Figure 2-11) is displayed as long as the condition continues.



Figure 2-11 Message Page

## SECTION 3: NAV PAGES

### 3.1 MAIN PAGE GROUPS

The GNS 430's main pages are divided into four separate page groups: NAV, WPT, AUX, and NRST (Table 3-1). Each page group is comprised of multiple pages. The page groups are selected using the large **right** knob. The individual pages are selected using the small **right** knob.

| Page Groups |               |                |               |
|-------------|---------------|----------------|---------------|
| NAV Group   | WPT Group     | AUX Group      | NRST Group    |
| 7 NAV Pages | see Section 7 | see Section 10 | see Section 8 |

Table 3-1 Page Groups

The bottom right corner of the screen (Figure 3-1) indicates which page group is currently being displayed (e.g., NAV, WPT, AUX, or NRST), the number of screens available within that group (indicated by the square icons), and the placement of the current screen within that group (indicated by a highlighted square icon).

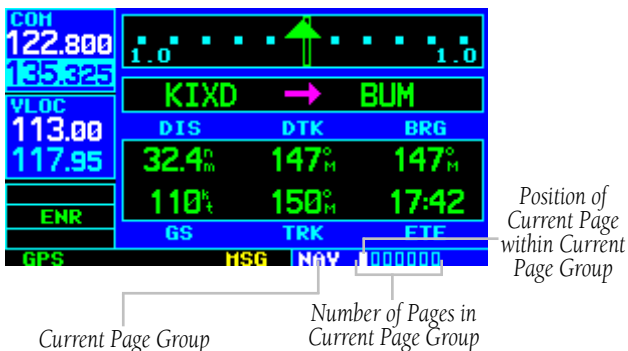

Figure 3-1 Current Page and Page Group

To select the desired page group (from any page):

Press and hold the **CLR** Key to select the Default NAV Page. Turn the large **right** knob to select the desired page group (Table 3-1 and Figure 3-1).

To select the desired page within the group:

Turn the small **right** knob to select the desired page (Figures 3-1 and 3-2).

### 3.2 NAV PAGE GROUP

The NAV Page Group includes seven pages (Figure 3-2). While viewing any NAV page, turn the small **right** knob to select a different NAV page. The pilot may find this selection process convenient to cycle between the Default NAV Page and the Map Page, which are two of the most frequently used pages. Other pages are provided for terrain information (if configured for TERRAIN), to list frequencies for the flight plan, show the current position, display current satellite reception, and make vertical navigation settings.

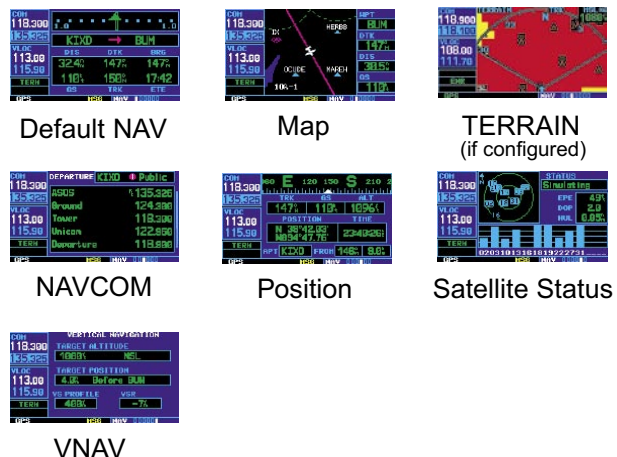
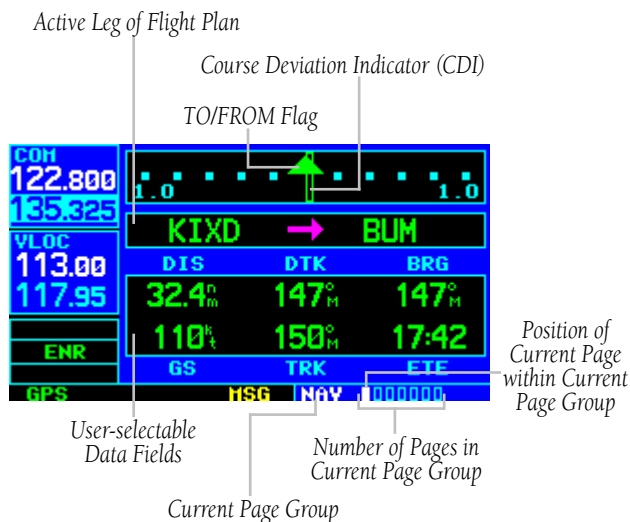

Figure 3-2 NAV Pages

### 3.3 DEFAULT NAV PAGE

The first NAV page is the Default NAV Page (Figure 3-3). This page may be quickly selected from any page by pressing and holding the **CLR** Key.



**Figure 3-3 Default NAV Page**

The Default NAV Page displays a graphic course deviation indicator (CDI) across the top of the page. Unlike the angular limits used on a mechanical CDI coupled to a VOR or ILS receiver, full scale limits for this CDI are defined by a GPS-derived distance (0.3, 1.0 or 5.0 nm), as indicated at both ends of the CDI. By default, the CDI scale automatically adjusts to the desired limits based upon the current phase of flight: enroute, terminal area or approach. The pilot may also manually select the desired scale setting as outlined in Section 10.4. The graphic CDI shows the current position at the center of the indicator, relative to the desired course (the moving course deviation needle). As with a traditional mechanical CDI, when off course simply steer toward the needle. The TO/FROM arrow in the center of the scale indicates whether the aircraft is heading TO (up arrow) or FROM the waypoint (down arrow).



**NOTE:** The GNS 430 always navigates TO a waypoint unless the OBS switch is set (preventing automatic waypoint sequencing), or if the aircraft has passed the last waypoint in the flight plan.

Directly below the CDI appears the active leg of the flight plan, or the direct-to destination when using the **Direct-to** Key. This automatically sequences to the next leg of the flight plan as each interim waypoint is reached. If no flight plan or direct-to destination has been selected, the destination field remains blank.

The following symbols are used on the Default NAV Page (directly below the CDI), to depict the 'active leg' of a flight plan or direct to:

- Direct-to a Waypoint
- Course to a Waypoint, or Desired Course between Two Waypoints
- Procedure Turn
- Procedure Turn
- Vectors-to-Final
- DME Arc to the Left
- DME Arc to the Right
- Left-hand Holding Pattern
- Right-hand Holding Pattern

## Selecting Desired On-Screen Data

At the bottom of the Default NAV Page there are six user-definable fields which display the data needed as the flight progresses (Figure 3-3). By default these fields display: distance to destination (DIS), desired track (DTK), bearing to destination (BRG), ground speed (GS), ground track (TRK), and estimated time enroute (ETE). However, each of these fields can be customized to display a different data item. Available data items include:

- Bearing to destination (BRG)
- Course to steer (CTS)
- Cross track error (XTK)
- Desired track (DTK)
- Distance to destination (DIS)
- Enroute safe altitude (ESA)
- Estimated time of arrival (ETA)
- Estimate time enroute (ETE)
- Fuel flow (FLOW) (when configured)
- Ground speed (GS)
- Ground track (TRK)
- Minimum safe altitude (MSA)
- Track angle error (TKE)
- Vertical speed required (VSR)

If no flight plan or direct-to destination has been selected, only speed, track, altitude, and minimum safe altitude data may be displayed. All other data types appear as blank lines on the Default NAV Page until a destination is selected.

To select a different data item for any data field:

- 1) Starting with the Default NAV Page, press the **MENU** Key to display the Default NAV Page Menu (Figure 3-4).



Figure 3-4 Default NAV Page Menu

- 2) The 'Change Fields?' option is already highlighted, so press the **ENT** Key to select this option.
- 3) Use the large **right** knob to highlight the data field to be changed (Figure 3-5).



Figure 3-5 'DIS' Field Highlighted

- 4) Turn the small right knob to display the list of available data items (Figure 3-6). Continue turning the small right knob to select the desired data item from the list.



Figure 3-6 Select Field Type Window

- 5) Press the **ENT** Key to select the desired data item and return to the Default NAV Page.
- 6) Press the small **right** knob momentarily to remove the cursor from the page.

### Restoring Factory Settings

All data fields settings can be quickly returned to original factory settings.

#### To restore all six data fields to factory default settings:

- 1) From the Default NAV Page, press the **MENU** Key to display the Default NAV Page Menu.
- 2) Turn the large **right** knob to highlight the 'Restore Defaults?' option (Figure 3-7) and press the **ENT** Key.



Figure 3-7 Default NAV Page Menu

### Dual Unit Considerations

A 'Crossfill?' option is also provided for the Default NAV Page. This option transfers a direct-to destination or flight plan to a second Garmin 400 Series unit. See Section 10.2, Flight Planning: Crossfill for additional details on using the crossfill option.

### 3.4 MAP PAGE

The second NAV page is the Map Page (Figure 3-8), which displays the present position using an airplane symbol, along with nearby airports, NAVAIDS, user-defined waypoints, airspace boundaries, lakes, rivers, highways, and cities.

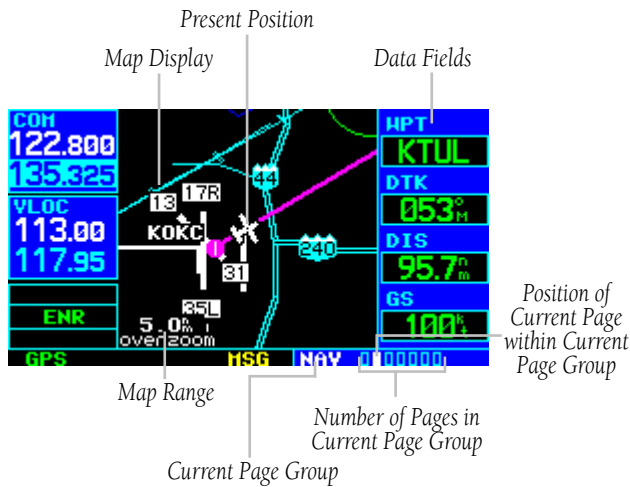

Figure 3-8 Map Page



**NOTE:** If the GNS 430 is unable to determine a GPS position, the present position (airplane) symbol does not appear on the Map Page.

Different symbols are used to distinguish between waypoint types. The identifiers for any on-screen waypoints can also be displayed. (The identifiers are enabled by default.) Special-use and controlled airspace boundaries appear on the map, showing the individual sectors for Class B, Class C, and Class D airspaces.

The following symbols are used to depict the various airports and NAVAIDS on the Map Page:

- Airport with hard surface runway(s);  
(primary runway shown)
- Airport with soft surface runway(s) only
- Private Airfield
- VOR
- VOR/DME
- DME
- Localizer
- Intersection
- VORTAC
- TACAN
- NDB
- Locator Outer Marker

The Map Display can be set to 23 different range settings from 500 feet to 2000 nautical miles (statute and metric units are also available). The range is indicated in the lower left-hand corner of the Map Display (Figure 3-8), and represents the top-to-bottom distance covered by the Map Display.

## To select a map range:

- 1) Press the up arrow of the **RNG** Key to zoom out to a larger map area.
- 2) Press the down arrow of the **RNG** Key to zoom in to a smaller map area and more detail.

An autozoom feature is available which automatically adjusts from an enroute range of 2000 nm through each lower range, stopping at a range of 1.0 nm when approaching the destination waypoint. The autozoom feature is turned on/off from the Map Setup Page (described in Section 3.4).

The Map Page also displays a background map (or 'basemap') showing lakes, rivers, coastlines, highways, railways, and towns. When a map range is selected below the lower limit at which the map detail was originally created, an 'overzoom' indication appears on the Map Display, below the range reading (Figure 3-9). The basemap has limited accuracy, and should not be used for navigation, but only for non-navigational situational awareness. Any basemap indication should be compared against other navigational sources for accuracy. Continuing to zoom in to lower range settings will cause 'overzoom' to be replaced with 'no map' and the geographic detail will be removed from the Map Display (airport and NAVAID remain).



Figure 3-9 Overzoom on Map Page

The 'Setup Map?' option (described in Section 3.4) allows the pilot to define the maximum range at which each map feature appears. This provides the pilot with complete control to minimize screen clutter. The pilot can also quickly remove items from the map using the **CLR** Key.

## To quickly declutter the Map Display:

Press the **CLR** Key momentarily (as often as needed) to select the desired amount of map detail.

The **CLR** Key allows the pilot to quickly declutter the Map Display, providing four levels of map detail. Note the '-2' ('-1' and '-' are also provided) suffix designation in Figure 3-10, indicating each successive declutter level.



Figure 3-10 Detail Level on Map Page

The right-hand side of the Map Page includes four user-selectable data fields (Figure 3-8). By default, the displayed data is: destination waypoint name (WPT), desired track (DTK), distance to destination waypoint (DIS), and ground speed (GS). Any of these data fields may be changed to display a different data type, as outlined in Section 3.4. The four data fields can also be removed from the map to show a larger map image, as described in Section 3.4.



## Map Panning

Another Map Page function is panning, which allows the map to move beyond its current limits without adjusting the map range. When the panning function is selected (by pressing the small **right** knob), a target pointer flashes on the Map Display (Figure 3-11). A window also appears at the top of the Map Display showing the latitude/longitude position of the pointer, plus the bearing and distance to the pointer from the present position.

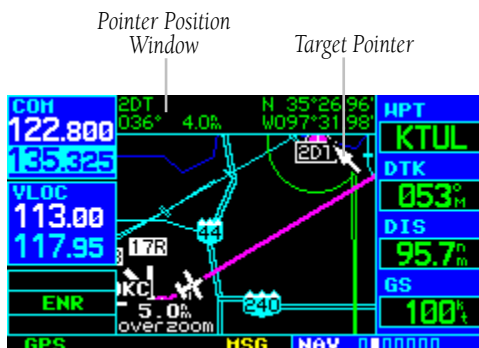

Figure 3-11 Panning on Map Page

### To select the panning function and pan the Map Display:

- 1) Press the small **right** knob to activate the panning target pointer.
- 2) Turn the small **right** knob to move up (turn clockwise) or down (counterclockwise).
- 3) Turn the large **right** knob to move right (turn clockwise) or left (counterclockwise).
- 4) To cancel the panning function and return to the present position, press the small **right** knob.

When the target pointer is placed on an object, the name of that object is highlighted (even if the name wasn't originally displayed on the map). This feature applies to airports, NAVAIDS, user-created waypoints, roads, lakes, rivers, almost everything displayed on the map except route lines.

When an airport, NAVAID, or user waypoint is selected on the Map Display, information about the waypoint can be reviewed or the waypoint can be designated as the direct-to destination.

### To review information for an on-screen airport, NAVAID or user waypoint:

- 1) Use the panning function (as described in the preceding procedure) to place the target pointer on a waypoint (Figure 3-11).
- 2) Press the **ENT** Key to display the Waypoint Information Page(s) for the selected waypoint (Figure 3-12).

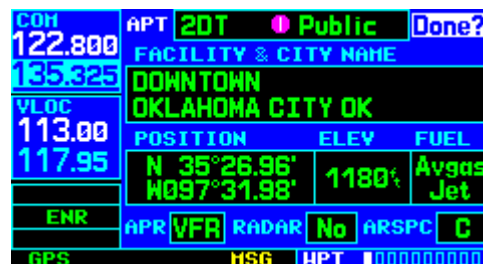

Figure 3-12 Information for On-Screen Waypoint

- 3) Press the **CLR** Key to exit the information page(s).

**Map Direct-to**

**To designate an on-screen airport, NAVAID, or user waypoint as the direct-to destination:**

- 1) Use the panning function ('Map Panning' in this section) to place the target pointer on a waypoint.
- 2) Press the **Direct-to** Key to display the select Direct-to Waypoint Page, with the selected waypoint already listed (Figure 3-13).



Figure 3-13 +MAP Waypoint

- 3) Press the **ENT** Key twice to confirm the selection and begin navigating to the waypoint.

The direct-to function can be used anywhere on the map. If nothing currently exists at the target pointer location, a new waypoint called '+MAP' (Figure 3-13) is created at the target pointer location before the direct-to is initiated.

**Airspace Information on the Map**

When a special-use or controlled airspace boundary appears on the Map Display, the pilot can quickly retrieve information (such as floor/ceiling limits and controlling agency) directly from the map.

**To view airspace information for an on-screen special-use or controlled airspace:**

- 1) Use the panning function ('Map Panning' in this section) to place the target pointer on an open area within the boundaries of an airspace. If the area is congested and it is difficult to select an open area, it may be necessary to zoom in or press the **CLR** Key to make the selection easier (Figure 3-14).



Figure 3-14 Select Airspace with Target Pointer

- 2) Press the **ENT** Key to display an options menu (Figure 3-15).



Figure 3-15 Map Panning Options Window

- 3) 'Review Airspace?' should already be highlighted, if not select it with the small **right** knob. Press the **ENT** Key to display the Airspace Information Page for the selected airspace.
- 4) To display the COM frequency(ies) for the controlling agency, turn the large **right** knob to highlight 'Frequencies?' and press the **ENT** Key. Press the **CLR** Key to return to the Airspace Information Page.
- 5) Press the **CLR** Key to exit the Airspace Information Page.

## Map Setup

Many of the GNS 430's functions are menu driven. Each of the main pages has an options menu, allowing customization of the corresponding page to the pilot's preferences and/or selection of special features which specifically relate to that page. A Map Page Menu (Figure 3-16) provides additional settings to customize the Map Page and additional features related specifically to the Map Page.

### To display the Map Page Menu:

Press the **MENU** Key with the Map Page displayed (Figure 3-16).



Figure 3-16 Map Page Menu

The following options are available: 'Setup Map?', 'Measure Dist?', 'Data Fields Off?', 'Change Fields?', and 'Restore Defaults?'.

'Setup Map?' allows configuration of the Map Display to individual preferences, including map orientation, land data enable/disable, Jeppesen data enable/disable, automatic zoom, airspace boundaries, and text size.

The following settings are available for each group:

|                 |   |
|-----------------|---|
| <b>Map</b>      | Orientation, AutoZoom, Land Data, Aviation Data   |
| <b>Weather</b>  | Lightning Mode/Symbol (when applicable)           |
| <b>Traffic</b>  | Traffic Mode/Symbol/Label (when applicable)       |
| <b>Airport</b>  | Large/Medium/Small Airports and Text              |
| <b>NAVAID</b>   | VORs, NDBs, Intersections, and Text               |
| <b>Waypoint</b> | User Waypoints, Waypoint Text, Flight Plan Wpts   |
| <b>Line</b>     | Active Flight Plan, Lat/Long                      |
| <b>Control</b>  | Controlled Airspace: Class B, C, D (tower zone)   |
| <b>Airspace</b> | Special-Use Airspace: Restricted, MOA, Other      |
| <b>City</b>     | Large/Medium/Small Cities and Text                |
| <b>Road</b>     | Freeway, National Highway, Local Hwy, Local Road  |
| <b>Other</b>    | States/Prov, Rivers/Lakes, Railroads, Wind Vector |



**NOTE:** Large, medium, and small classifications are used on the GNS 430 for airports and cities. Large airports are those with a runway longer than 8100 feet. Medium airports include those with a runway longer than 5000 feet or with a control tower. Large cities are those with approximate populations greater than 200,000 and medium cities with greater than 50,000.

### To change map orientation:

- 1) From the Map Page Menu, turn the large **right** knob to highlight 'Setup Map?' (Figure 3-16) and press the **ENT** Key.
- 2) Turn the small **right** knob to select 'Map' (Figure 3-17) and press the **ENT** Key.



Figure 3-17 Map Setup Window

- 3) Turn the large **right** knob to highlight the 'Orientation' field.
- 4) Turn the small **right** knob to select the desired option.
  - a) Select 'DTK up' to fix the top of the Map Display to the desired course.
  - b) Select 'North up' to fix the top of the Map Display to a north heading.
  - c) Select 'Track up' (Figure 3-18) to adjust the top of the Map Display to the current track heading.

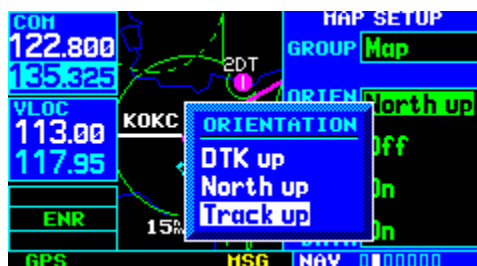

Figure 3-18 Orientation Window

- d) Press the **ENT** Key to accept the selected option (Figure 3-19).



Figure 3-19 Map Setup Page

#### To enable/disable automatic zoom:

- 1) From the Map Page Menu, turn the large **right** knob to highlight 'Setup Map?' and press the **ENT** Key.
- 2) Turn the small **right** knob to select 'Map' and press the **ENT** Key.
- 3) Turn the large **right** knob to highlight the 'Auto Zoom' field.
- 4) Turn the small **right** knob to select 'On' or 'Off'.
- 5) Press the **ENT** Key to accept the selected option. The automatic zoom feature automatically adjusts the map range from 2000 nm through each lower range, stopping at 1.0 nm when approaching the destination waypoint.

#### To enable/disable the wind vector, all background land data, or all Jeppesen aviation data:

- 1) From the Map Page Menu, turn the large **right** knob to highlight 'Setup Map?' and press the **ENT** Key.
- 2) Turn the small **right** knob to select 'Map' and press the **ENT** Key.

- 3) Turn the large **right** knob to highlight the appropriate field.
- 4) Turn the small **right** knob to select 'On' or 'Off'.
- 5) Press the **ENT** Key to accept the selected option.

#### For airports, NAVAIDs, active flight plan waypoints, user-created waypoints, state/provincial boundaries, rivers/lakes, and cities:

- 1) From the Map Page Menu, turn the large **right** knob to highlight 'Setup Map?' and press the **ENT** Key.
- 2) Turn the small **right** knob to select the appropriate 'Group' name (per the chart on the preceding page) and press the **ENT** Key.
- 3) Turn the large **right** knob to highlight the zoom field for the desired feature.
- 4) Turn the small **right** knob to select the maximum range at which the feature should appear on screen (or select 'Off' to never display the selected feature).
- 5) Press the **ENT** Key to accept the selected option.
- 6) Turn the large **right** knob to highlight the text field for the desired feature.
- 7) Turn the small **right** knob to select the desired text size, or select 'None' to disable text descriptions.
- 8) Press the **ENT** Key to accept the selected option.

**For airspace boundaries, highways, roads, railroad lines, track log data, active flight plan course lines, and lat/long grid lines:**

- 1) From the Map Page Menu, turn the large **right** knob to highlight 'Setup Map?' and press the **ENT** Key.
- 2) Turn the small **right** knob to select the appropriate 'Group' name (per the chart on the preceding page) and press the **ENT** Key.
- 3) Turn the large **right** knob to highlight the zoom field for the desired feature.
- 4) Turn the small **right** knob to select the maximum range at which the feature should appear on screen (or select 'Off' to never display the selected feature).
- 5) Press the **ENT** Key to accept the selected option.

### Distance Measurements

The 'Measure Dist?' option provides a quick, easy method for determining the bearing and distance between any two points on the Map Display.

**To measure bearing and distance between two points:**

- 1) From the Map Page Menu, turn the large **right** knob to highlight 'Measure Dist?' (Figure 3-20).



Figure 3-20 Map Page Menu

- 2) Press the **ENT** Key, an on-screen reference pointer appears on the Map Display at the present position.

- 3) Turn the small and large **right** knobs to place the reference pointer at the desired location to measure FROM and press the **ENT** Key (Figure 3-21).



Figure 3-21 Using Pointer to Measure Distance and Bearing

- 4) Again, use the small and large **right** knobs to place the reference pointer at the desired location to measure TO. The bearing and distance from the first reference location appears at the top of the Map Display.
- 5) To exit the 'Measure Dist?' option, press the small **right** knob.

### Selecting Full Screen Map

The 'Data Fields Off?' option provides a full-screen Map Display (Figure 3-22), without the four data fields along the right-hand side of the screen. Select this option to display a larger map area. If this option has been selected and the data fields are off, 'Data Fields On?' appears as an option instead.



Figure 3-22 Full Screen Map

**To turn the data fields off/on:**

From the Map Page Menu, Turn the large **right** knob to highlight 'Data Fields Off?' (or 'Data Fields On?') and press the **ENT** Key.

**Selecting Desired On-Screen Data**

'Change Fields?' allows selection of the data displayed on the four user-selectable data fields along the right-hand side of the Map Page. There are fourteen available data types, including bearing to destination, distance to destination, estimated time of arrival, ground speed, minimum safe altitude, and track. See Section 13.3 for descriptions of these (and other) navigation terms.

**To change a data field:**

- 1) From the Map Page Menu, turn the large **right** knob to highlight 'Change Fields?' (Figure 3-23) and press the **ENT** Key.

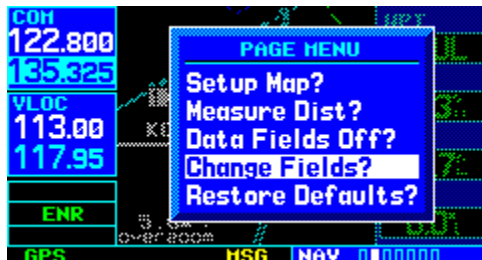

Figure 3-23 Map Page Menu

- 2) Turn the large **right** knob to highlight the data field to be changed.

- 3) Turn the small **right** knob to select the type of data (Figure 3-24) desired to appear on this field and press the **ENT** Key.



Figure 3-24 Select Data Field Window

- 4) Press the small **right** knob to remove the cursor.



*NOTE: The on-screen traffic information occupies two data fields, leaving room to display only two additional data types. Traffic information is only available when the GNS 430 installation includes connection to traffic information sources. See 400 Series Pilot's Guide Addendum, part number 190-00140-13.*

**Restoring Factory Settings**

'Restore Defaults?' resets all four user-selectable data fields to their original factory default settings.

**To restore the factory default settings:**

From the Map Page Menu, turn the large **right** knob to highlight 'Restore Defaults?' (Figure 3-25) and press the **ENT** Key.



Figure 3-25 Map Page Menu

### 3.5 TERRAIN PAGE

#### TERRAIN Page

The TERRAIN Page is the third page in the NAV Page Group. To display the TERRAIN Page, select the NAV Page Group and turn the small **right** knob until the TERRAIN Page is displayed (Figure 3-26). The TERRAIN Page displays terrain information, aircraft ground track, and GPS-derived MSL altitude. Altitude is shown in increments of 20 feet or in increments of 10 meters, depending on unit configuration. The 'G' to the right of the MSL altitude display reminds the pilot that altitude is GPS-derived.



*NOTE: The TERRAIN Page does not appear on GNS 430 units that are not properly equipped with or configured for TERRAIN. See Section 11 for a full description of TERRAIN functions.*

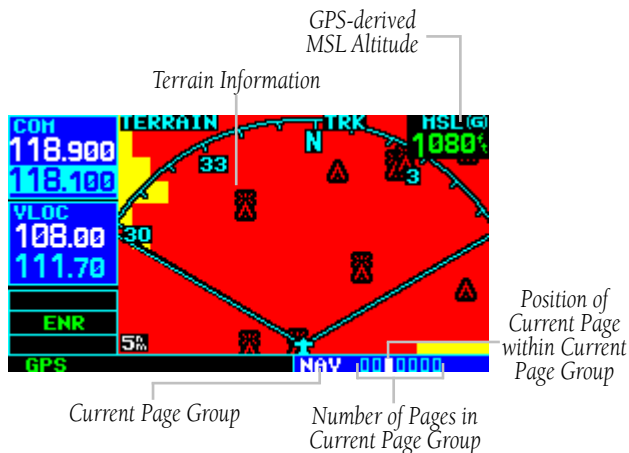

**Figure 3-26 TERRAIN Page**

#### Selectable Display Settings

The TERRAIN Page has two selectable view settings:

- 360° View - View from above aircraft depicting surrounding terrain on all sides
- 120° View - View of terrain ahead of and 60° to either side of the aircraft flight path (Figure 3-26)



*NOTE: The TERRAIN Page gives a 'Track Up' display orientation, as indicated by the 'TRK' label shown on the display. This is the only orientation available on this page.*

#### To display a 360° view:

- 1) Select the TERRAIN Page and press the **MENU** Key.
- 2) Select 'View 360°?' (Figure 3-27).



**Figure 3-27 TERRAIN Page Menu**

- 3) Press the **ENT** Key. To switch back to a 120° view, repeat step 1, select 'View 120°?', and press the **ENT** Key.



Seven display ranges are available, allowing for a more complete view of the surrounding area.

### To change the display range:

Select the TERRAIN Page and press up or down on the **RNG** Key to select the desired range: 1 nm, 2 nm, 5 nm, 10 nm, 25 nm, 50 nm, 100 nm (Figure 3-28).

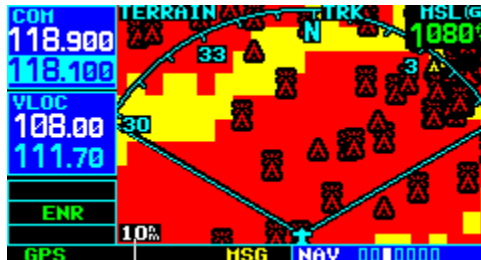

DisplayRange Field

Figure 3-28 TERRAIN Display Range

Aviation information such as airports, VORs, and other NAVAIDS can be turned on or off from the TERRAIN Page.

### To show or hide aviation data:

- 1) Select the TERRAIN Page and press the **MENU** Key.
- 2) Select 'Show (or Hide) Aviation Data' (Figure 3-29) and press the **ENT** Key. Pressing the **CLR** Key when the TERRAIN Page is displayed can also be used to toggle aviation information on or off.



Figure 3-29 TERRAIN Page Menu

## Inhibit Mode

The Garmin TERRAIN system provides an 'inhibit mode'. This mode is designed to deactivate terrain alerting when deemed unnecessary by the pilot. Flying VFR into an area where unique terrain exists could cause the system to annunciate nuisance alerts. Pilots should use discretion when inhibiting the TERRAIN system and always remember to enable the system when appropriate. See Section 11.3 for more information on TERRAIN alerts.

### To inhibit TERRAIN:

- 1) Select the TERRAIN Page and press the **MENU** Key. 'Inhibit Terrain?' is selected by default (Figure 3-30).



Figure 3-30 TERRAIN Page Menu

- 2) Press the **ENT** Key. The 'TER INHB' annunciation is displayed in the TERRAIN annunciator field when TERRAIN is inhibited (Figure 3-31).



Annunciator Field

**Figure 3-31 TERRAIN Annunciator Field**

**To enable TERRAIN:**

- 1) Select the TERRAIN Page and press the **MENU** Key. 'Enable Terrain?' is selected by default.
- 2) Press the **ENT** Key. The TERRAIN system is functional again.

**TERRAIN Symbols**

The following symbols (Figure 3-32) are used to represent obstacles and potential impact points on the Terrain Page.

- Red Symbol - Terrain/Obstacle is within 100 feet above or below the aircraft altitude
- Yellow Symbol - Terrain/Obstacle is between 1000 feet and 100 feet below the aircraft altitude



*NOTE: Obstacle symbols are shown on display zoom ranges up to 10 nm.*

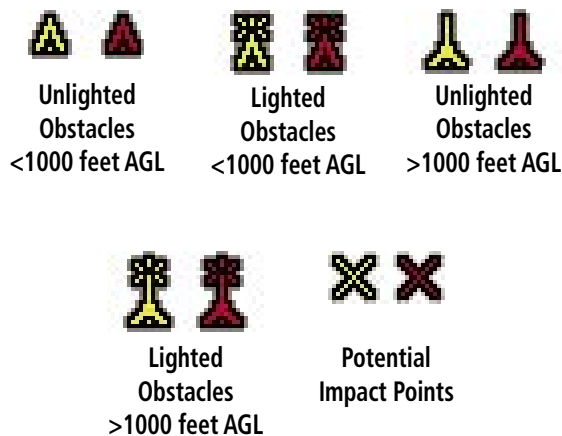

**Figure 3-32 TERRAIN Symbols**

### 3.6 NAV/COM PAGE

The fourth NAV page is the NAV/COM (navigation communications) Page (Figure 3-33). The NAV/COM Page provides a list of the airport communication and navigation frequencies at the departure, enroute, and arrival airports. The NAV/COM Page makes selection of the frequencies needed along the flight plan quick and convenient. If there is no active flight plan with a departure airport, the NAV/COM Page displays the frequencies for the airport nearest the departure position.

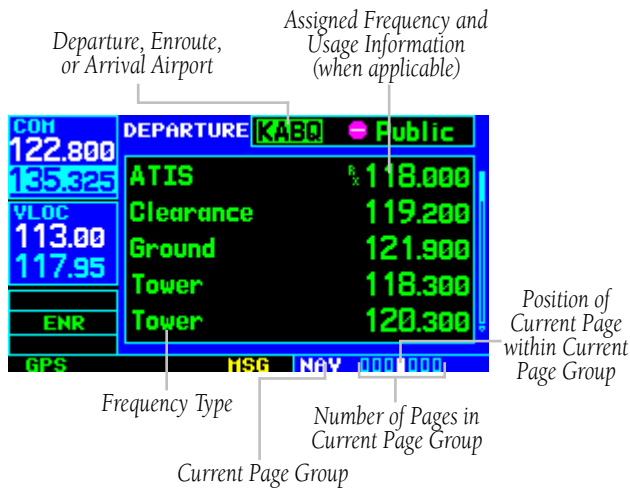

Figure 3-33 NAV/COM Page

To select a frequency list for a departure, enroute or arrival airport:

- 1) Press the small **right** knob to activate the cursor.
- 2) Turn the large **right** knob to place the cursor on the airport identifier field (top line on the NAV/COM Page, see Figure 3-33).
- 3) Turn the small **right** knob to select the desired airport (Figure 3-34) and press the **ENT** Key.



Figure 3-34 Airport Window

**To scroll through the list of frequencies:**

- 1) Activate the cursor, if not already active, by pressing the small **right** knob.
- 2) Turn the large **right** knob to move the cursor through the list of frequencies. If there are more frequencies in the list that can be displayed on the screen, a scroll bar along the right-hand side of the screen (Figure 3-35) indicates which part of the list is currently being displayed.

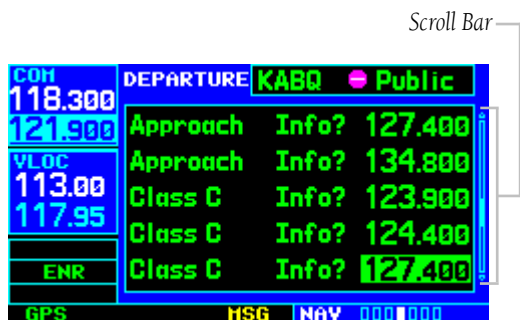

**Figure 3-35 Scroll Bar**

- 3) To place a frequency in the standby field of the COM or VLOC Window, highlight the desired frequency and press the **ENT** Key.

Some listed frequencies may include designations for limited usage, as follows:

- ‘TX’ - Transmit only
- ‘RX’ - Receive only
- ‘PT’ - Part time frequency

If a listed frequency has sector or altitude restrictions, the frequency is preceded by an ‘Info?’ designation.

**To view usage restrictions for a frequency:**

- 1) Turn the large **right** knob to place the cursor on the ‘Info?’ designation directly in front of the desired frequency (Figure 3-36).



**Figure 3-36 ‘Info’ Highlighted**

- 2) Press the **ENT** Key to display the restriction information (Figure 3-37).

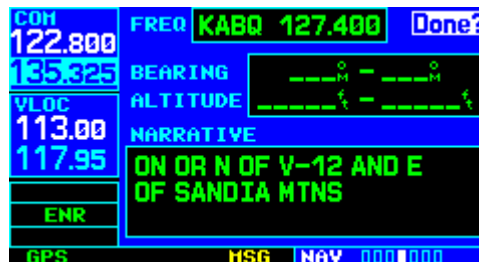

**Figure 3-37 Restriction Information Page**

- 3) To return to the NAV/COM Page, press the **ENT** Key.

### 3.7 POSITION PAGE

The Position Page (the fifth NAV page) displays the present position (by default, in latitude and longitude) and altitude. The Position Page (Figure 3-38) also displays the current track, ground speed, time, and a reference waypoint field. These fields are user-selectable to configure the page to the pilot's own preferences and current navigation needs.

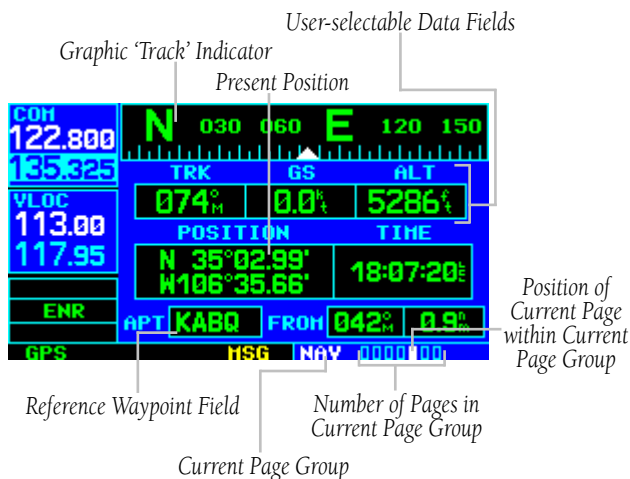

Figure 3-38 Position Page

The graphic 'track' indicator at the top of the page indicates the direction the aircraft is heading, or track, only when moving. The graphic 'track' indicator and the TRK indication directly below it provide the same information. Use the graphic 'track' indicator for quick at-a-glance ground track information. Directly below are three user-selectable fields, which by default, display track, ground speed, and altitude. Barometric pressure (BARO) settings and minimum safe altitude (MSA) can also be displayed in these fields. MSA is the recommended minimum altitude within approximately ten miles of the present position. MSA is calculated from the information contained in the database and generally takes into account mountains, buildings, and other permanent features.



*NOTE: Do not rely solely on MSA as an absolute measure of safe altitude. Consult current area charts and NOTAMS.*

#### To change the user-selectable data fields:

- 1) Press the **MENU** Key to display the Position Page Menu (Figure 3-39).



Figure 3-39 Position Page Menu

- 2) Turn the large **right** knob to highlight 'Change Fields?' and press the **ENT** Key.
- 3) Turn the large **right** knob to highlight the data field to be changed.
- 4) Turn the small **right** knob to display the list of available data items (Figure 3-40). Continue turning the small **right** knob to select the desired data item from the list.



Figure 3-40 Select Field Type Window

- 5) Press the **ENT** Key to select the desired data item and return to the Position Page.
- 6) Press the small **right** knob momentarily to remove the cursor from the page.

The Position Page also features a reference waypoint field, located at the bottom of the page, to indicate bearing and distance to/from a selected waypoint. The reference waypoint field can display bearing and distance information for a nearby airport (default), VOR, NDB, intersection, or user waypoint.

**To change the reference waypoint information:**

- 1) Press the **MENU** Key to display the Position Page Menu (Figure 3-39).
- 2) Turn the large **right** knob to highlight 'Change Fields?' and press the **ENT** Key.
- 3) Turn the large **right** knob to highlight the waypoint type field (bottom left corner of the page; default setting shows 'APT' see Figure 3-41).

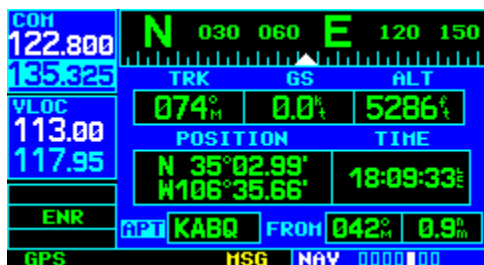

Figure 3-41 Waypoint Type Field Highlighted

- 4) Turn the small **right** knob to display the list of available waypoint types (Figure 3-42). Continue turning the small **right** knob to select the desired data item from the list.



Figure 3-42 Category Window

- 5) If 'WPT' is selected as the waypoint type, any airport, NAVAID, or user waypoint can be designated as a reference waypoint. Press the small **right** knob, turn the large **right** knob to highlight the waypoint identifier field (Figure 3-43), then use the small and large **right** knobs to enter the identifier of the desired waypoint. Press the **ENT** Key to confirm the selected waypoints. Press the small **right** knob to remove the cursor.

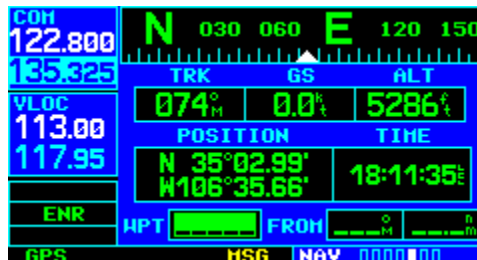

Figure 3-43 Reference Waypoint Field Highlighted

- 6) Press the **ENT** Key to select the desired type and return to the Position Page.
- 7) To select between 'bearing FROM' or 'bearing TO' to the reference waypoint, turn the small **right** knob to select the desired bearing reference (Figure 3-44) and press the **ENT** Key.



Figure 3-44 Mode Window

- 8) Press the small **right** knob momentarily to remove the cursor from the page.

## Restoring Factory Settings

A 'Restore Defaults?' option allows all data fields to be reset to their original factory default settings. This returns the three user-selectable fields at the top of the page AND the reference waypoint fields to default settings.

### To restore the factory default settings:

- 1) Press the **MENU** Key to display the Position Page Menu (Figure 3-45).

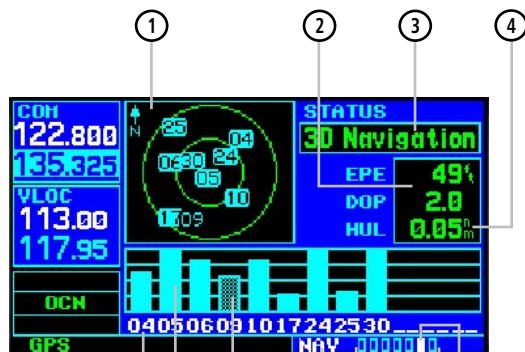

Figure 3-45 Position Page Menu

- 2) Turn the large **right** knob to highlight 'Restore Defaults?' and press the **ENT** Key.

### 3.8 SATELLITE STATUS PAGE

The Satellite Status Page (the sixth NAV page) provides a visual reference of GPS receiver functions, including current satellite coverage, GPS receiver status, and position accuracy. The Satellite Status Page (Figure 3-46) is helpful in troubleshooting weak (or missing) signal levels due to poor satellite coverage or installation problems.



- ① Sky View
- ② Estimated Position Error (EPE) and Dilution of Precision (DOP)
- ③ GPS Receiver Status
- ④ Horizontal Uncertainty Level (HUL)
- ⑤ Satellite ID Numbers
- ⑥ Signal Strength Bars
- ⑦ Excluded Satellite
- ⑧ Current Page Group
- ⑨ Number of Pages in Current Page Group
- ⑩ Position of Current Page within Current Page Group

**Figure 3-46 Satellite Status Page**

As the GPS receiver locks onto satellites, a signal strength bar appears for each satellite in view, with the appropriate satellite number (01-32) underneath each bar. The progress of satellite acquisition is shown in three stages:

- No signal strength bars - The receiver is looking for the satellites indicated.
- Hollow signal strength bars - The receiver has found the satellite(s) and is collecting data (Figure 3-47).
- Solid signal strength bars - The receiver has collected the necessary data and the satellite(s) is ready for use.
- Checkered signal strength bars - Excluded satellites (Figure 3-46)

The sky view display (at top left corner of the page) shows which satellites are currently in view, and where they are. The outer circle of the sky view represents the horizon (with north at top of the page); the inner circle 45° above the horizon; and the center point directly overhead.

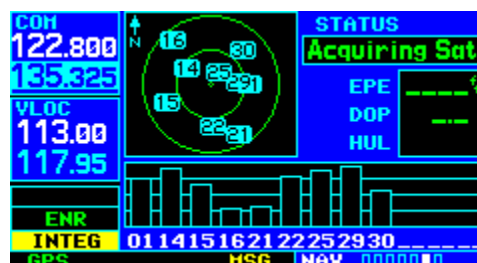

**Figure 3-47 Hollow Signal Strength Bars**



Each satellite has a 30-second data transmission that must be collected (hollow signal strength bar, see Figure 3-47) before the satellite may be used for navigation (solid signal strength bar, see Figure 3-46). Once the GPS receiver has determined the present position, the GNS 430 indicates position, track, and ground speed on the other navigation pages. The GPS receiver status field (Figure 3-46) also displays the messages listed in Table 3-2 under the appropriate conditions:

The Satellite Status Page also indicates the accuracy of the position fix, using Estimated Position Error (EPE), Dilution of Precision (DOP), and Horizontal Uncertainty Level (HUL) figures. DOP measures satellite geometry quality (i.e., number of satellites received and where they are relative to each other) on a scale from one to ten. The lowest numbers are the best accuracy and the highest numbers are the worst. EPE uses DOP and other factors to calculate a horizontal position error, in feet or meters. HUL is explained in Section 12.

| <b>GPS Receiver Status Messages</b> |   |
|-------------------------------------|---|
| Searching Sky                       | The GPS receiver is searching the sky for ANY visible satellites. The pilot is informed of this status with a 'Searching the Sky' message.  |
| Acquiring Sat                       | The GPS receiver is acquiring satellites for navigation. In this mode, the receiver uses satellite orbital data (collected continuously from the satellites) and last known position to determine which satellites should be in view. |
| 2D Navigation                       | The GPS receiver is in 2D navigation mode. Altitude data is provided by an altitude serializer.   |
| 3D Navigation                       | The GPS receiver is in 3D navigation mode and computes altitude using satellite data.   |
| Poor Coverg                         | The GPS receiver cannot acquire sufficient satellites for navigation.   |
| Rcvr Not Usbl                       | The GPS receiver is unusable due to incorrect initialization or abnormal satellite conditions. Turn the unit off and on again.  |
| AutoLocate                          | The GPS receiver is looking for any available satellite. This process can take up to five minutes to determine a position.  |

**Table 3-2 GPS Receiver Status Messages**

### 3.9 VERTICAL NAVIGATION PAGE

The GNS 430's Vertical Navigation Page (the last NAV page, see Figure 3-48) creates a three-dimensional profile to provide guidance from the present position and altitude to a final (target) altitude at a specified location. This is helpful when descending to a certain altitude near an airport or climbing to an altitude before reaching a route or direct-to waypoint (Figure 3-49). Once the profile is defined, message alerts and additional data on the Default NAV Page and the Map Page provide guidance to the pilot.

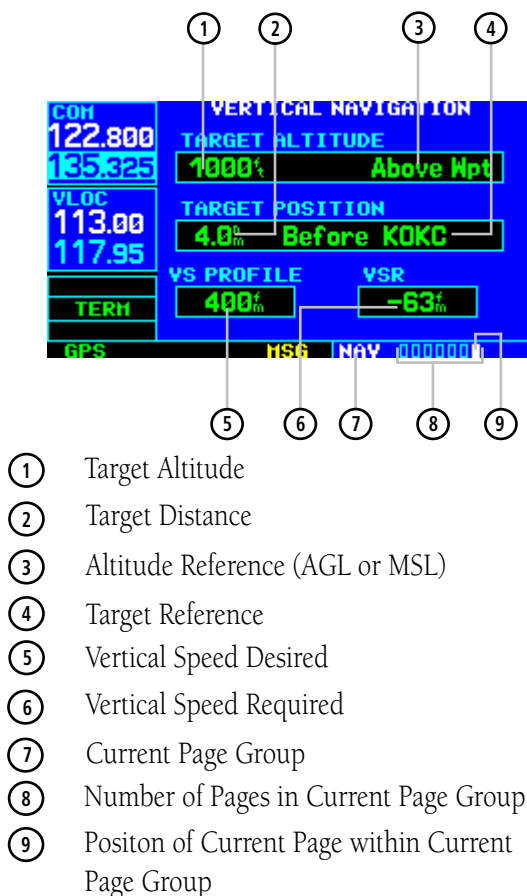

Figure 3-48 Vertical Navigation (VNAV) Page



*NOTE: To use the vertical navigation features, ground speed must be greater than 35 knots and the pilot must be navigating to a direct-to destination or using a flight plan.*

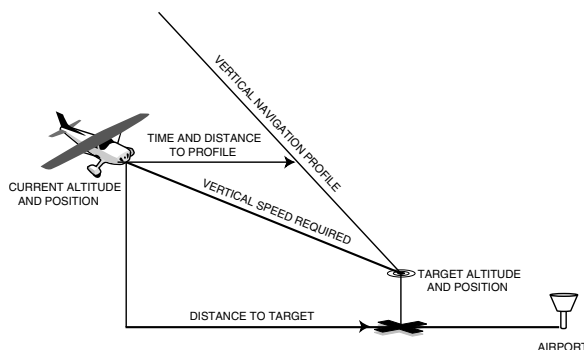

Figure 3-49 Vertical Navigation Profile

#### To create a vertical navigation profile (Figure 3-49):

- 1) Press the small **right** knob to activate the cursor.
- 2) Turn the large **right** knob to highlight the target altitude field.
- 3) Turn the small and large **right** knobs to select the target altitude (Figure 3-50) and press the **ENT** Key.



Figure 3-50 Target Altitude Field Selected

- 4) Turn the small **right** knob to select 'Above Wpt' (AGL) or 'MSL', (Figure 3-51) and press the **ENT** Key. 'Above Wpt' uses the altitude of a destination airport as stored in the Jeppesen NavData card. 'MSL' lets the pilot set a specific target altitude for any waypoint category: airport, VOR, NDB, intersection, or user waypoint.



Figure 3-51 Reference Window

- 5) Turn the small and large **right** knobs to select a distance from the target reference waypoint (Figure 3-52) and press the **ENT** Key. If the target altitude should occur at the target reference waypoint, enter a distance of zero.



Figure 3-52 Reference Distance Selected

- 6) Turn the small **right** knob to select 'Before' or 'After', and press the **ENT** Key. This setting designates whether the offset distance defines a point before the aircraft reaches the target reference waypoint, or after the aircraft reaches the waypoint.
- 7) When using a flight plan, the target reference waypoint itself can be specified from the waypoints contained in the flight plan. By default, the last waypoint in the flight plan is selected. To select a different waypoint, turn the small **right** knob to select the desired waypoint and press the **ENT** Key.
- 8) The default profile utilizes a 400 fpm descent rate. To change the rate, turn the large **right** knob to highlight the 'VS Profile' field (Figure 3-53) and use the small and large **right** knobs to enter a new rate. Press the **ENT** Key when finished.



Figure 3-53 VS Profile Field Selected

With the profile set, the vertical speed required (VSR) is displayed on the Vertical Navigation Page. Expect the following to occur when using the vertical navigation feature:

- At one minute prior to reaching the initial descent point, a message ‘Approaching VNAV Profile’ occurs. The descent (or climb) angle also locks to prevent changes in speed from altering the profile.
- If selected, the vertical speed required (VSR) readout on the Default NAV Page and the Map Page show the desired vertical speed to maintain the proper descent (or climb) angle.
- At 500 feet above (or below, for a climb) the target altitude, an ‘Approaching Target Altitude’ message is provided. The VSR readout on the Default NAV Page and the Map Page is blanked out, at this point.

Vertical navigation messages can be turned on or off. (By default the messages are off.) Turning the messages off allows the pilot to keep the previous profile settings, without having them generate messages when the feature isn’t needed.

## To disable/enable the vertical navigation (VNAV) messages:

- 1) Press the **MENU** Key to display the Vertical Navigation Page Menu (Figure 3-54).



Figure 3-54 VNAV Page Menu

- 2) With ‘VNAV Messages On?’ highlighted, press the **ENT** Key. Or, if the messages are already on, to turn them off, make sure ‘VNAV Messages Off?’ is highlighted and press the **ENT** Key.

## SECTION 4: DIRECT-TO NAVIGATION

### 4.1 OVERVIEW

The GNS 430's direct-to function provides a quick method of setting a course to a destination waypoint. Once a direct-to is activated, the GNS 430 establishes a point-to-point course line (great circle) from the present position to the selected direct-to destination. Navigation data on the various NAV pages provides steering guidance until the direct-to is cancelled or replaced by a new destination.

#### To select a direct-to destination:

- 1) Press the **Direct-to** Key. The Select Direct-to Waypoint Page appears (Figure 4-1), with the waypoint identifier field highlighted.



Figure 4-1 Select Direct-to Waypoint Page

- 2) Use the small and large **right** knobs to enter the identifier of the desired destination waypoint (Figure 4-2).

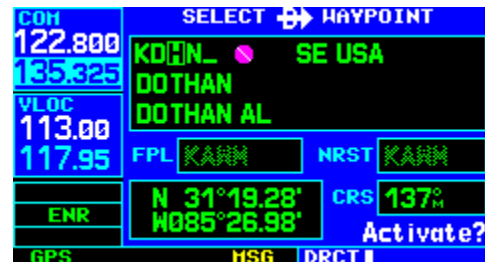

Figure 4-2 Waypoint Identifier Field Selected

- 3) Press the **ENT** Key to confirm the selected waypoint, and press the **ENT** Key again to activate the direct-to function (Figure 4-3).

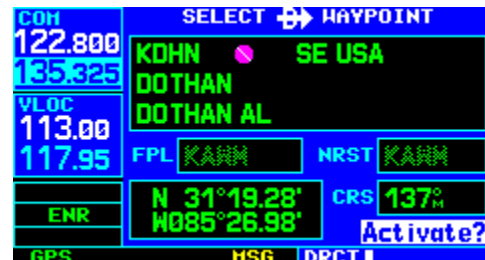

Figure 4-3 'Activate?' Field Highlighted

When off course while navigating to a waypoint, the direct-to function may also be used to re-center the CDI (HSI) needle and proceed to the same waypoint.

#### To re-center the CDI (HSI) needle to the same destination waypoint:

Press the **Direct-to** Key, followed by the **ENT** Key twice.



**NOTE:** When navigating an approach with the missed approach point (MAP) as the current destination, re-centering the CDI (HSI) needle with the **Direct-to** Key cancels the approach.

## Selecting a Destination by Facility Name or City

In addition to selecting a destination by identifier, the Select Direct-to Waypoint Page (Figure 4-4) also allows the pilot to select airports, VORs and NDBs by facility name or city location. If duplicate entries exist for the entered facility name or city, additional entries may be viewed by continuing to turn the small **right** knob during the selection process. See Section 7.1, Duplicate Waypoints for more information.

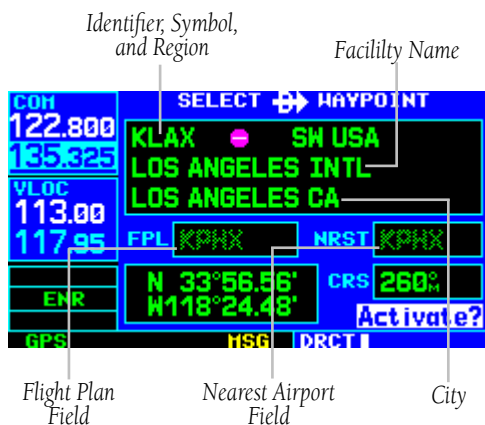

Figure 4-4 Select Direct-to Waypoint Page

### To select a direct-to destination by facility name or city:

- 1) Press the **Direct-to** Key. The Select Direct-to Waypoint Page appears, with the waypoint identifier field highlighted.
- 2) Turn the large **right** knob to highlight the facility name (second line) or the city (third line) field.

- 3) Use the small and large **right** knobs to enter the facility name or city location of the desired destination waypoint (Figure 4-5). When spelling the facility name or city, the GNS 430's Spell'N'Find™ feature selects the first entry in the database based upon the characters entered up to that point.

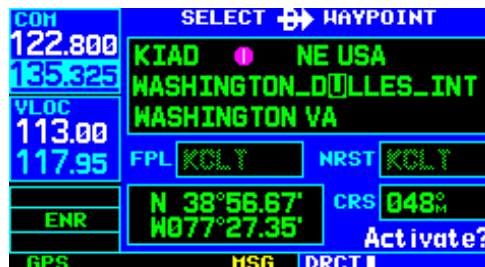

Figure 4-5 Facility Name Selected

- 4) Continue turning the small **right** knob to scroll through any additional database listings for the selected facility name or city. The pilot can also scroll backwards with the small **right** knob if the desired waypoint has been scrolled past .
- 5) Press the **ENT** Key to confirm the selected waypoint, and press the **ENT** Key again to activate the direct-to function.

## Selecting a Destination from the Active Flight Plan

When navigating an active flight plan, any waypoint contained in the flight plan may be selected as a direct-to destination from the Select Direct-to Waypoint Page. See Section 5, for more information on flight plans.

To select a direct-to destination from the active flight plan:

- 1) Press the **Direct-to** Key. The Select Direct-to Waypoint Page appears, with the waypoint identifier field highlighted.
- 2) Turn the large **right** knob to highlight the flight plan (FPL) field (Figure 4-6).



Figure 4-6 Highlighted Flight Plan Field

- 3) Turn the small **right** knob to display a window showing all waypoints in the active flight plan (Figure 4-7).



Figure 4-7 FPL (Flight Plan) Window

- 4) Continue turning the small **right** knob to scroll through the list and highlight the desired waypoint.
- 5) Press the **ENT** Key to confirm the selected waypoint, and press the **ENT** Key again to activate the direct-to function.

Selecting the Nearest Airport as a Direct-to Destination

The Select Direct-to Waypoint Page always displays the nearest airports (from the present position) in the NRST field. Navigating directly to a nearby airport is always just a few simple steps away. (Nearby airports may also be selected as direct-to destinations using the steps described in Section 8.1.)

To select a nearby airport as a direct-to destination:

- 1) Press the **Direct-to** Key. The Select Direct-to Waypoint Page appears, with the waypoint identifier field highlighted.
- 2) Turn the large **right** knob to highlight the nearest airport (NRST) field.
- 3) Turn the small **right** knob to display a window showing up to nine nearby airports (Figure 4-8).



Figure 4-8 Nearest Window

- 4) Continue turning the small **right** knob to scroll through the list and highlight the desired airport.
- 5) Press the **ENT** Key to confirm the selected airport, and press the **ENT** Key again to activate the direct-to function.

**Shortcuts**

Shortcuts are available when using the **Direct-to** Key, allowing the pilot to bypass the use of the small and large **right** knobs to enter the destination waypoint's identifier. A direct-to can be performed from any page displaying a single waypoint identifier (such as the WPT pages for airports and NAVAIDS, see Figure 4-9) by simply pressing the **Direct-to** Key and the **ENT** Key. For pages that display a list of waypoints (e.g., the Nearest Airport Page, see Figure 4-10), the desired waypoint must be highlighted with the cursor before pressing the **Direct-to** Key.

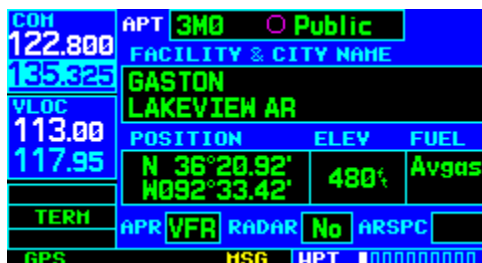

Figure 4-9 Single Waypoint Displayed



Figure 4-10 Nearest List

**To select an on-screen waypoint as a direct-to destination:**

- 1) If a single airport, NAVAID, or user waypoint is displayed on-screen: press the **Direct-to** Key, then press the **ENT** Key twice.
- 2) If a list of waypoints is displayed on-screen: press the small **right** knob to activate the cursor.
- 3) Turn the large **right** knob to highlight the desired waypoint.
- 4) Press the **Direct-to** Key followed by the **ENT** Key twice.



## Selecting a Direct-to destination from the Map Page

Direct-to destinations may also be selected from the Map Page. If no airport, NAVAID, or user waypoint exists at the desired location, a waypoint named '+MAP' is automatically created at the location of the panning pointer.

### To select a direct-to destination from the Map Page:

- 1) From the Map Page, press the small **right** knob to display a panning pointer.
- 2) Turn the small and large **right** knobs to place the panning pointer at the desired destination location.
- 3) If the panning pointer is placed on an existing airport, NAVAID or user waypoint, the waypoint name is highlighted (Figure 4-11). Press the **Direct-to** Key and the **ENT** Key twice to navigate to the waypoint.



Figure 4-11 Panning Pointer Placed on Waypoint

- 4) If the panning pointer is placed on an open location, press the **Direct-to** Key, then press the **ENT** Key twice to create a '+MAP' waypoint and navigate to it.

## Cancelling Direct-to Navigation

Once a direct-to is activated, the GNS 430 provides navigation guidance to the selected destination until the direct-to is replaced with a new direct-to or flight plan, cancelled, or the unit is turned off.

### To cancel a direct-to:

- 1) Press the **Direct-to** Key to display the Select Direct-to Waypoint Page.
- 2) Press the **MENU** Key to display the Direct-to Page Menu (Figure 4-12).



Figure 4-12 Select Direct-to Page Menu

- 3) With 'Cancel Direct-to NAV?' highlighted, press the **ENT** Key. If a flight plan is still active, the GNS 430 resumes navigating the flight plan along the closest leg.

### Specifying a Course to a Waypoint

When performing a direct-to, the GNS 430 sets a direct great circle course to the selected destination. The course to the destination can also be manually defined using the 'CRS' course field on the Select Direct-to Waypoint Page.

#### To manually define the direct-to course:

- 1) Press the **Direct-to** Key.
- 2) Use the small and large **right** knobs to select the destination waypoint.
- 3) Press the **ENT** Key to confirm the selected waypoint, then turn the large **right** knob to highlight the course ('CRS') field (Figure 4-13).

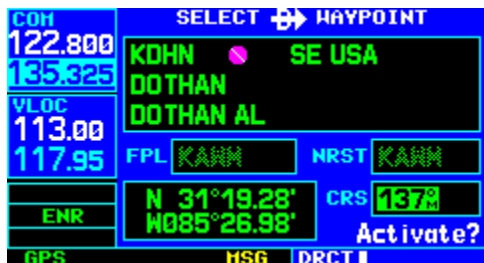

Figure 4-13 CRS (Course) Field Highlighted

- 4) Turn the small and large **right** knobs to select the desired course (Figure 4-14) and press the **ENT** Key.

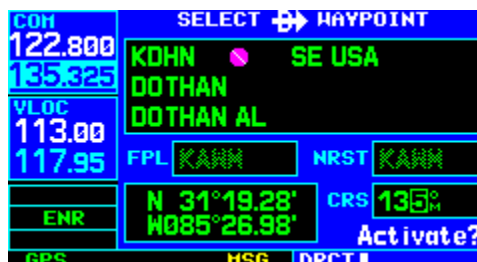

Figure 4-14 Course Field Selected

- 5) Press the **ENT** Key again to begin navigation using the selected destination and course.
- 6) To re-select a direct course from present position (or select a new manually-defined course), simply press the **Direct-to** Key, followed by the **ENT** Key twice.

## SECTION 5: FLIGHT PLANS

The GNS 430 lets the pilot create up to 20 different flight plans, with up to 31 waypoints in each flight plan. The Flight Plan Page Group consists of two pages, accessed by pressing the **FPL** Key. The flight plan pages allow the pilot to create, edit, and copy flight plans.

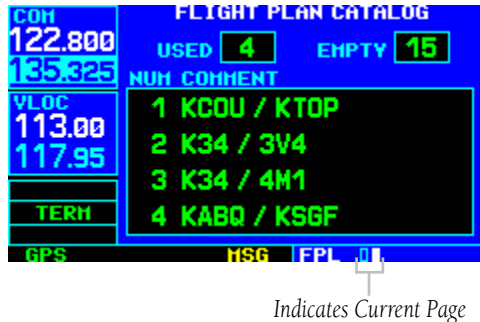

Figure 5-1 Flight Plan Catalog Page

### 5.1 FLIGHT PLAN CATALOG PAGE

The Flight Plan Catalog Page allows the pilot to create, edit, activate, delete, and copy flight plans. Flight plans numbered from 1 through 19 are used to save flight plans for future use. 'Flight plan 00' is reserved exclusively for the flight plan currently in use for navigation. When a flight plan is activated, a copy of the flight plan is automatically transferred to 'flight plan 00' and overwrites any previously active flight plan.

#### To create a new flight plan:

- 1) Press the **FPL** Key and turn the small **right** knob to display the Flight Plan Catalog Page (Figure 5-1).
- 2) Press the **MENU** Key to display the Flight Plan Catalog Page Menu (Figure 5-2).

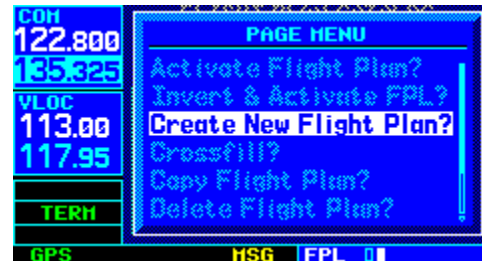

Figure 5-2 Flight Plan Catalog Page Menu

- 3) Turn the large **right** knob to highlight 'Create New Flight Plan?' and press the **ENT** Key.

- 4) A blank Flight Plan Page appears for the first empty storage location (Figure 5-3). Use the small and large **right** knobs to enter the identifier of the departure waypoint and press the **ENT** Key.



Figure 5-3 Flight Plan Page

- 5) Repeat step 4 above to enter the identifier for each additional flight plan waypoint.
- 6) Once all waypoints have been entered, press the small **right** knob to return to the Flight Plan Catalog Page.

## Flight Plan Editing

**To add a waypoint to an existing flight plan:**

- 1) Press the **FPL** Key and turn the small **right** knob to display the Flight Plan Catalog Page.
- 2) Press the small **right** knob to activate the cursor.
- 3) Turn the large **right** knob to highlight the desired flight plan and press the **ENT** Key.
- 4) Turn the large **right** knob to select the point to add the new waypoint. If an existing waypoint is highlighted, the new waypoint is placed directly in front of this waypoint (Figure 5-4).



Figure 5-4 Flight Plan Page

- 5) Use the small and large **right** knobs to enter the identifier of the new waypoint and press the **ENT** Key (Figure 5-5).

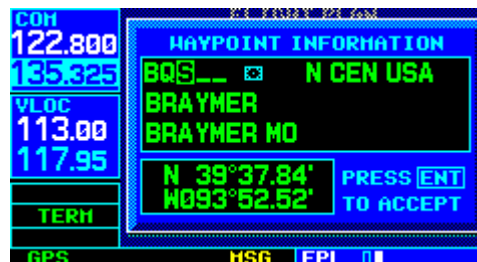

Figure 5-5 Waypoint Identifier Field Selected

- 6) Once all changes have been made, press the small **right** knob to return to the Flight Plan Catalog Page (Figure 5-6).



Figure 5-6 Edited Flight Plan Page

**To delete a waypoint from an existing flight plan:**

- 1) Press the **FPL** Key and turn the small **right** knob to display the Flight Plan Catalog Page.
- 2) Press the small **right** knob to activate the cursor.
- 3) Turn the large **right** knob to highlight the desired flight plan and press the **ENT** Key.
- 4) Turn the large **right** knob to select the waypoint to be deleted and press the **CLR** Key to display a 'remove waypoint' confirmation window.
- 5) With 'Yes' highlighted, press the **ENT** Key to remove the waypoint.
- 6) Once all changes have been made, press the small **right** knob to return to the Flight Plan Catalog Page.

A one-line user comment may be added to any flight plan, which is displayed on the Flight Plan Catalog Page, next to the flight plan's number. By default, as the flight plan is being created, the comment shows the first and last waypoints in the flight plan.

**To change the comment line for an existing flight plan:**

- 1) From the Flight Plan Catalog Page, press the small **right** knob to activate the cursor.
- 2) Turn the large **right** knob to highlight the desired flight plan and press the **ENT** Key.
- 3) Turn the large **right** knob to select the comment line at the top of the screen.
- 4) Use the small and large **right** knobs to enter the new comment (Figure 5-7). Press the **ENT** Key when finished.

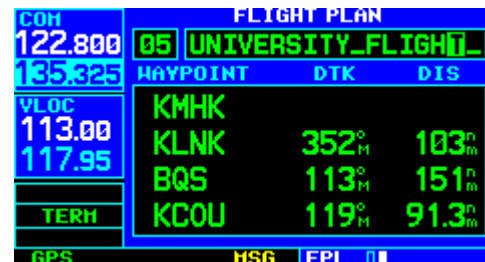

Figure 5-7 Comment Line Selected

- 5) Once all changes have been made, press the small **right** knob to return to the Flight Plan Catalog Page.

## Activating Flight Plans

Once a flight plan is defined through the Flight Plan Catalog Page (using the steps outlined previously in this section), it may be activated for navigation. Activating the flight plan places it into 'flight plan 00' and overwrites any previous information at that location.

### To activate an existing flight plan:

- 1) From the Flight Plan Catalog Page, press the small **right** knob to activate the cursor.
- 2) Turn the large **right** knob to highlight the desired flight plan and press the **MENU** Key to display the Flight Plan Catalog Page Menu.
- 3) Turn the large **right** knob to highlight 'Activate Flight Plan?' and press the **ENT** Key (Figure 5-8).

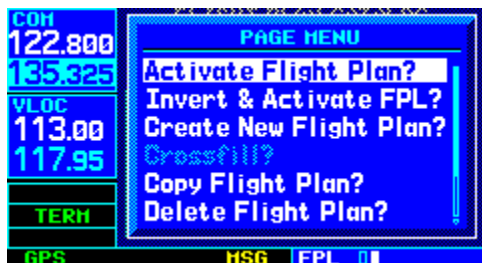

Figure 5-8 Flight Plan Catalog Page Menu

## Inverting Flight Plans

After travelling along a flight plan, the pilot may wish to reverse the route for navigation guidance back to the original departure point.

### To activate an existing flight plan in reverse order:

- 1) From the Flight Plan Catalog Page, press the small **right** knob to activate the cursor.
- 2) Turn the large **right** knob to highlight the desired flight plan and press the **MENU** Key to display the Flight Plan Catalog Page Menu.
- 3) Turn the large **right** knob to highlight 'Invert & Activate FPL?' (Figure 5-9) and press the **ENT** Key. The original flight plan remains intact in its flight plan catalog storage location.

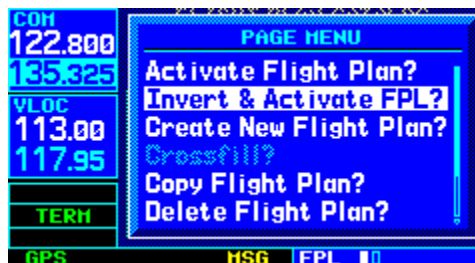

Figure 5-9 Flight Plan Catalog Page Menu

## Copying Flight Plans

To save a flight plan currently located in 'flight plan 00', copy it to an open catalog location (1-19) before the flight plan is cancelled, overwritten, or erased.

### To copy a flight plan to another flight plan catalog location:

- 1) From the Active Flight Plan Page, press the **MENU** Key to display the Active Flight Plan Page Menu.
- 2) From the Flight Plan Catalog Page, press the small **right** knob to activate the cursor, turn the large **right** knob to highlight the flight plan to be copied, then press the **MENU** Key to display the Flight Plan Catalog Page Menu.
- 3) Turn the large **right** knob to highlight 'Copy Flight Plan?' (Figure 5-10) and press the **ENT** Key.



Figure 5-10 Flight Plan Catalog Page Menu

- 4) By default, the next empty catalog location is offered. To select a different location, turn the large **right** knob to select the flight plan number, use the small and large **right** knobs to enter a different number and press the **ENT** Key.
- 5) With 'Yes?' highlighted, press the **ENT** Key to copy the flight plan.

## Deleting Flight Plans

When finished with a flight plan, it can easily be deleted from the Flight Plan Catalog Page or the Active Flight Plan Page.

### To delete a flight plan:

- 1) From the Active Flight Plan Page, press the **MENU** Key to display the Active Flight Plan Page Menu.
- 2) From the Flight Plan Catalog Page, press the small **right** knob to activate the cursor, turn the large **right** knob to highlight the flight plan to be deleted, then press the **MENU** Key to display the Flight Plan Catalog Page Menu.
- 3) Turn the large **right** knob to highlight 'Delete Flight Plan?' (Figure 5-11) and press the **ENT** Key.

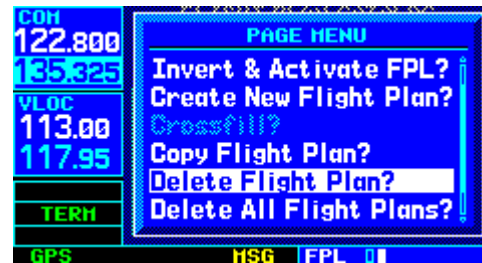

Figure 5-11 Flight Plan Catalog Page Menu

- 4) With 'Yes?' highlighted, press the **ENT** Key to delete the flight plan.

## Flight Plan Catalog Options

The following options (some covered on the preceding pages) are available for the Flight Plan Catalog Page:

- ‘Activate Flight Plan?’ - Allows the pilot to select the flight plan for navigation guidance, as described previously in this section.
- ‘Invert & Activate FPL?’ - Allows the pilot to reverse the highlighted flight plan and select it for navigation guidance, as described previously in this section.
- ‘Create New Flight Plan?’ - Allows the pilot to create a new flight plan, as described previously in this section.
- ‘Crossfill?’ - Allows the pilot to transfer a Direct-to destination, the active flight plan, any stored flight plan or user waypoints to a second 400-Series or 500-Series Garmin unit. Some crossfill operations can be done automatically. If both units are set to ‘auto’, a change in the direct-to destination or active flight plan on one unit is seen on the other. For additional information, see Section 10.2, Flight Planning Page: Crossfill.

### To crossfill flight plans between two 400- or 500-Series Garmin units:

- 1) Select the ‘Crossfill?’ option from the Flight Plan Catalog Page Menu (Figure 5-12) and press the **ENT** Key.



Figure 5-12 Flight Plan Catalog Page Menu

- 2) Turn the large **right** knob to select the ‘Method’ field (Figure 5-13).

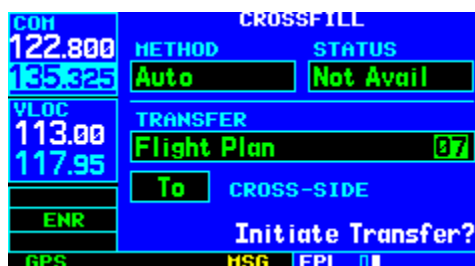

Figure 5-13 Crossfill Page

- 3) Turn the small **right** knob to select ‘Auto’ or ‘Manual’ and press the **ENT** Key. ‘Auto’ automatically transfers the active flight plan or Direct-to selection to another 400- or 500-series Garmin unit, without user intervention.
- 4) If ‘Manual’ is selected: Turn the large **right** knob to select the ‘Transfer’ field, then turn the small **right** knob to select the type of information to transfer between units (active flight plan, flight plan, all user waypoints or a single user waypoint). When ‘Flight Plan’ or ‘User Waypoint’ is selected, a second field appears to the immediate right of the ‘Transfer’ field. Use the small and large **right** knobs to enter the number of the flight plan or the name of the user waypoint to be transferred.



- 5) The 'Cross-Side' field allows the pilot to designate the sending and receiving units in a crossfill operation. Turn the large **right** knob to select the 'Cross-side' field, then turn the small **right** knob to select 'To' or 'From' (Figure 5-14). Press the **ENT** Key to confirm the selection.



Figure 5-14 Transfer Window

- 6) Turn the large **right** knob to highlight 'Initiate Transfer?' and press the **ENT** Key.
- 'Copy Flight Plan?' - Allows the pilot to copy the selected flight plan to a new flight plan location, as described previously in this section. The copy function is useful for duplicating an existing flight plan before making changes.
  - 'Delete Flight Plan?' - Allows the pilot to remove the selected flight plan from memory, as described previously in this section. Deleting a flight plan does not delete the individual waypoints contained in the flight plan from the database or user waypoint memory.
  - 'Delete All Flight Plans?' - Allows the pilot to remove all flight plans from memory.

**To delete all flight plans:**

- 1) Select the 'Delete All Flight Plans?' option from the Flight Plan Catalog Page Menu (Figure 5-15) and press the **ENT** Key.

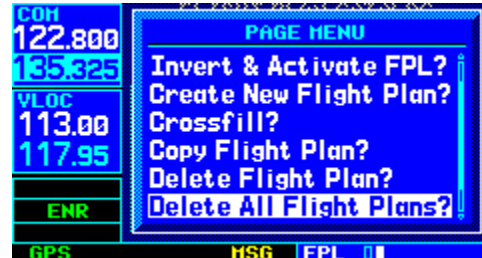

Figure 5-15 Flight Plan Catalog Page Menu

- 2) A confirmation window appears (Figure 5-16). With 'Yes?' highlighted, press the **ENT** Key.

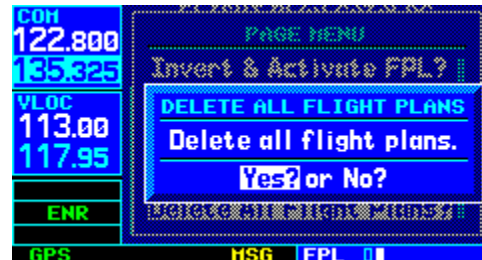

Figure 5-16 Delete All Flight Plans Window

- ‘Sort List By Number?’/‘Sort List by Comment?’  
- Allows the pilot to select between a flight plan catalog sorted numerically by the flight plan number or sorted alphanumerically based upon the comment assigned to each flight plan. When either option is selected, the other option appears on the Flight Plan Catalog Page Menu.

### To sort the catalog listing by number or comment:

- 1) Select the ‘Sort List By Number?’ or ‘Sort List By Comment?’ option (whichever is currently displayed) from the Flight Plan Catalog Page Menu (Figure 5-17) and press the **ENT** Key.



Figure 5-17 Flight Plan Catalog Page Menu

## 5.2 ACTIVE FLIGHT PLAN PAGE

The Active Flight Plan Page provides information and editing functions for ‘flight plan 00’, the flight plan currently in use for navigation. When a direct-to or flight plan has been activated, the Active Flight Plan Page shows each waypoint for the flight plan (or a single waypoint for a direct-to, Figure 5-18), along with the desired track (DTK) and distance (DIS) for each leg.



Figure 5-18 Active Flight Plan Page

### Active Flight Plan Options

The options shown in Table 5-1 are available for the Active Flight Plan Page.

#### To access the Active Flight Plan Menu Page:

- 1) Press the **FPL** Key to view the Active Flight Plan Page.
- 2) Press the **MENU** Key (Figure 5-19).



Figure 5-19 Active Flight Plan Page Menu

| <b>Active Flight Plan Page Menu Options</b> |  |
|---|--|
| Activate Leg                                | Activates/reactivates the flight plan and selects the highlighted leg as the 'active leg' (the leg which is currently used for navigation guidance).   |
| Crossfill                                   | Allows the pilot to transfer the active flight plan between two 400- or 500-series Garmin units in a dual unit installation. See Section 10.2, Flight Planning: Crossfill for additional information on this feature.  |
| Copy Flight Plan                            | Copies the active flight plan to a flight plan catalog location, as described previously in this section. The copy function is useful for duplicating the active flight plan before making changes.  |
| Invert Flight Plan                          | Reverses the active flight plan. See Section 5.1, Activating Flight Plans and Inverting Flight Plans.  |
| Delete Flight Plan                          | Allows the pilot to remove all waypoints from the selected flight plan, as described previously in this section. Deleting a flight plan does not delete the waypoints contained in the flight plan from the database or user waypoint memory.  |
| Select Approach                             | Allows the pilot to select a published instrument approach for the destination airport, or replace the current approach with a new selection. (In many cases, it is convenient to select approaches using the <b>PROC</b> Key as described in Section 6.1.)  |
| Select Arrival                              | Allows the pilot to select a published standard terminal arrival route (STAR) for the destination airport or replace the current arrival with a new selection (Section 6.1 for information on selecting arrivals using the <b>PROC</b> Key).   |
| Select Departure                            | Allows the pilot to select a published standard instrument departure (SID) for the departure airport or replace the current departure with a new selection. When using a direct-to, the GNS 430 uses the nearest airport as a reference when displaying available departures. See Section 6.1 for information on selecting departures using the <b>PROC</b> Key. |
| Remove Approach                             | Deletes the currently selected approach from the active flight plan.   |
| Remove Arrival                              | Deletes the current STAR from the active flight plan.  |
| Remove Departure                            | Deletes the current SID from the active flight plan.   |
| Closest Point of FPL                        | Calculates the bearing and closest distance that a flight plan passes from a reference waypoint. May also be used to create a new user waypoint along the flight plan at the location closest to the reference waypoint.   |
| Change Fields                               | Allows the pilot to select the desired data items to display on the Active Flight Plan Page, as described in this Section.   |
| Restore Defaults                            | Returns the data items to factory defaults, as described in this Section.  |

**Table 5-1 Active Flight Plan Page Menu Options**

The data fields for DTK and DIS are user-selectable and may be changed to display cumulative distance (CUM) to each waypoint, estimated time of arrival (ETA), estimated time enroute (ETE), or enroute safe altitude (ESA).

### To change a data field on the Active Flight Plan Page:

- 1) With the Active Flight Plan Page displayed, press the **MENU** Key to display the Active Flight Plan Page Menu.
- 2) Turn the large **right** knob to highlight 'Change Fields?' (Figure 5-20) and press the **ENT** Key.



Figure 5-20 Active Flight Plan Page Menu

- 3) Turn the large **right** knob to highlight the field to be changed.
- 4) Turn the small **right** knob to select the desired data item (Figure 5-21) and press the **ENT** Key.

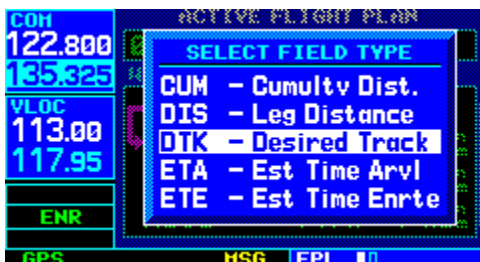

Figure 5-21 Select Field Type Window

- 5) Press the small **right** knob to remove the cursor.

### To restore factory default settings for data fields on the Active Flight Plan Page:

- 1) With the Active Flight Plan Page displayed, press the **MENU** Key to display the Active Flight Plan Page Menu.
- 2) Turn the large **right** knob to highlight 'Restore Defaults?' and press the **ENT** Key.

### To activate a flight plan along a specific leg:

- 1) Press the small **right** knob to activate the cursor and turn the large **right** knob to highlight the desired destination waypoint.
- 2) Press the **MENU** Key, and select the 'Activate Leg?' option from the Active Flight Plan Page Menu (Figure 5-22) and press the **ENT** Key.



Figure 5-22 Active Flight Plan Page Menu

- 3) A confirmation window appears. With 'Activate?' highlighted, press the **ENT** Key.

**To select an approach for a direct-to or flight plan destination airport:**

- 1) Choose the 'Select Approach?' option from the Active Flight Plan Page Menu (Figure 5-23) and press the **ENT** Key.



Figure 5-23 Active Flight Plan Page Menu

- 2) A window appears listing the available approaches (Figure 5-24) for the destination airport. Turn the small **right** knob to highlight the desired approach and press the **ENT** Key.

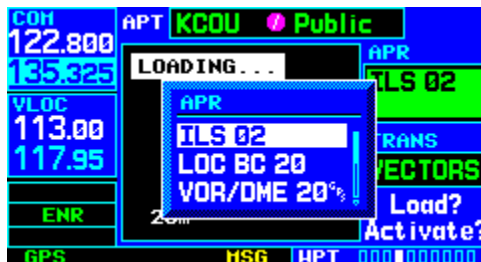

Figure 5-24 Approach Window

- 3) A second window appears listing available transitions (Figure 5-25) for the approach. Turn the small **right** knob to highlight the desired transition waypoint and press the **ENT** Key. (The 'Vectors' option assumes the pilot will receive vectors to the final course segment of the approach and will provide navigation guidance to intercept this final course.)



Figure 5-25 Transitions Window

- 4) Turn the large **right** knob to highlight 'Load?' or 'Activate?' and press the **ENT** Key. 'Load?' adds the approach to the flight plan without immediately using the approach for navigation guidance. This allows the pilot to continue navigating the original flight plan until cleared for the approach but keeps the approach available for quick activation when needed.
- 5) For precision approaches, a reminder window appears indicating that GPS guidance on such approaches is strictly for monitoring only. To confirm this reminder, highlight 'Yes?' and press the **ENT** Key.

## To select an arrival for a direct-to or flight plan destination airport:

- 1) Select the 'Select Arrival?' option from the Active Flight Plan Page Menu (Figure 5-26) and press the **ENT** Key.



Figure 5-26 Active Flight Plan Page Menu

- 2) A window appears listing the available arrivals (Figure 5-27) for the destination airport. Turn the small **right** knob to select the desired arrival and press the **ENT** Key.



Figure 5-27 Arrivals Window

- 3) A second window appears listing available transitions (Figure 5-28) for the arrival. Turn the small **right** knob to highlight the desired transition waypoint and press the **ENT** Key.



Figure 5-28 Transitions Window

- 4) With 'Load?' highlighted, press the **ENT** Key.

## To select a departure for the departure airport:

- 1) Select the 'Select Departure?' option from the Active Flight Plan Page Menu and press the **ENT** Key.
- 2) A window appears listing the available departures for the departure airport. Turn the small **right** knob to select the desired departure and press the **ENT** Key.
- 3) A second window appears listing available transitions for the departure. Turn the small **right** knob to highlight the desired transition waypoint and press the **ENT** Key.
- 4) With 'Load?' highlighted, press the **ENT** Key.

**To remove an approach, arrival, or departure from the active flight plan:**

- 1) Select the 'Remove Approach?', 'Remove Arrival?', or 'Remove Departure?' option from the Active Flight Plan Page Menu (Figure 5-29) and press the **ENT** Key.



Figure 5-29 Active Flight Plan Page Menu

- 2) A confirmation window appears listing the procedure to be removed. With 'Yes?' highlighted, press the **ENT** Key.

**To determine the closest point, along the active flight plan, to a selected waypoint:**

- 1) Select the 'Closest Point of FPL?' option from the Active Flight Plan Page Menu (Figure 5-30) and press the **ENT** Key.

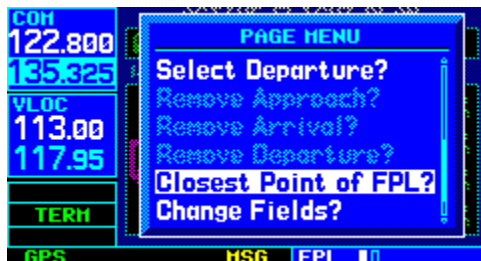

Figure 5-30 Active Flight Plan Page Menu

- 2) A window appears with the reference waypoint field highlighted. Use the small and large **right** knobs to enter the identifier of the reference waypoint and press the **ENT** Key.
- 3) A confirmation window appears for the selected reference waypoint (Figure 5-31). Press the **ENT** Key to accept the waypoint.



Figure 5-31 Closest Point of Flight Plan Window

- 4) The GNS 430 displays the bearing (BRG) and distance (DIST) to the closest point along the flight plan, from the selected reference waypoint. To create a user waypoint at this location and add it to the flight plan, highlight 'Load?' and press the **ENT** Key. The name for the new user waypoint is derived from the identifier of the reference waypoint.

## Shortcuts

A number of shortcuts are available to save time when using the Active Flight Plan Page. These shortcuts speed the process of removing approaches, departures and arrivals, and aid in selecting a specific flight plan leg for navigation guidance.

On the preceding page, options to remove approaches, departures, and arrivals were introduced. This process may also be completed using the **CLR** Key, as described below.

### To remove an approach, departure or arrival using the CLR Key:

- 1) With the Active Flight Plan Page displayed, press the small **right** knob to activate the cursor.
- 2) Turn the large **right** knob to highlight the title for the approach (Figure 5-32), departure, or arrival to be deleted. Titles appear in light blue directly above the procedure's waypoints.

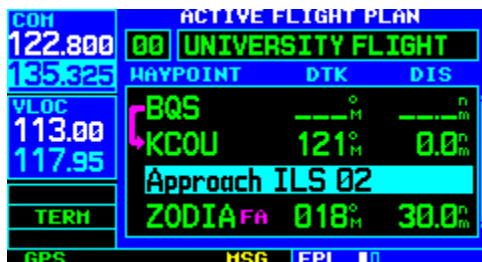

Figure 5-32 Highlight Item To Be Deleted

- 3) Press the **CLR** Key to display a confirmation window (Figure 5-33).

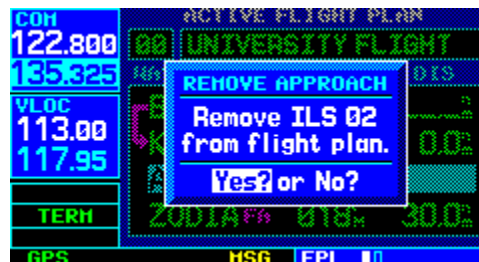

Figure 5-33 Remove Approach Window

- 4) With 'Yes?' highlighted, press the **ENT** Key to remove the selected procedure.

This same process may also be used to remove individual waypoints from the active flight plan.

### To remove a waypoint using the CLR Key:

- 1) With the Active Flight Plan Page displayed, press the small **right** knob to activate the cursor.
- 2) Turn the large **right** knob to highlight the identifier for the waypoint to be deleted. Identifiers appear in green text.
- 3) Press the **CLR** Key to display a confirmation window (Figure 5-34).



Figure 5-34 Remove Waypoint Window

- 4) With 'Yes?' highlighted, press the **ENT** Key to remove the selected procedure.



The ‘Activate Leg?’ option is discussed previously in this section, which allows the pilot to specify which leg of the flight plan is used for navigation guidance. A shortcut also exists for this operation, using the **Direct-to** Key.

**To activate a specific leg of the active flight plan:**

- 1) Press the small **right** knob to activate the cursor and turn the large **right** knob to highlight the desired destination waypoint (Figure 5-35).



Figure 5-35 Destination Waypoint Highlighted

- 2) Press the **Direct-to** Key twice to display an ‘Activate Leg’ confirmation window (Figure 5-36).



Figure 5-36 Activate Leg Window

- 3) With ‘Activate?’ highlighted, press the **ENT** Key.

When using instrument procedures, this feature can be used not only to activate a specific point-to-point leg, but to also activate the procedure turn portion of an approach, follow a DME arc, or activate a holding pattern.

Any approach, departure, or arrival can be reviewed on the appropriate airport page in the Waypoint Page Group (Section 7.1).

**To review a procedure while viewing a flight plan page:**

- 1) With a flight plan page displayed, press the small **right** knob to activate the cursor.
- 2) Turn the large **right** knob to highlight the procedure header (Figure 5-37) and press the **ENT** Key to select the WPT Page Group.

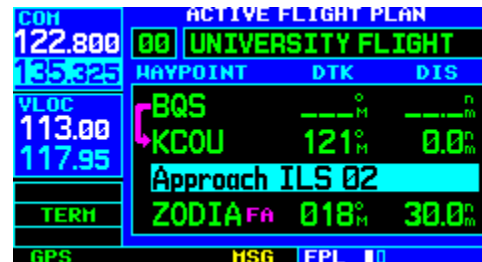

Figure 5-37 Procedure Header Highlighted

Blank Page

## SECTION 6: PROCEDURES

### 6.1 APPROACHES, DEPARTURES AND ARRIVALS

The GNS 430 allows the pilot to fly non-precision and precision approaches to airports with published instrument approach procedures. All available approaches are stored on the Jeppesen NavData card, and are automatically updated when the new card is inserted into the GNS 430. Subscription information for NavData cards is included in the GNS 430 package.

The Procedures Page (Figure 6-1) is displayed by pressing the **PROC** Key. The Procedures Page provides direct access to approaches, departures, and arrivals, based upon the active flight plan or direct-to destination. In either case, the departure and destination airports must have published procedures associated with them.

#### To select an approach, departure, or arrival:

- 1) Press the **PROC** Key to display the Procedures Page.
- 2) Turn the large **right** knob to highlight 'Select Approach?', 'Select Departure?' or 'Select Arrival?' (Figure 6-1) and press the **ENT** Key.

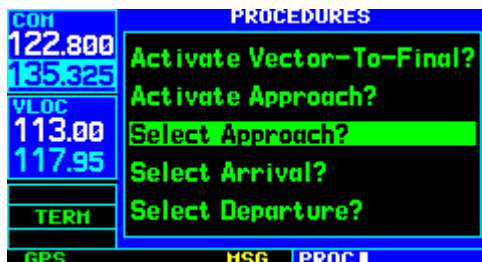

Figure 6-1 Procedures Page

- 3) A window appears listing the available procedures (Figure 6-2). Turn the large **right** knob to highlight the desired procedure and press the **ENT** Key. (When a direct-to destination is selected, departures are offered for the nearest airport.)



Figure 6-2 Approach Window

- 4) A second window appears listing the available transitions (Figure 6-3). Turn the large **right** knob to highlight the desired transition waypoint and press the **ENT** Key. (The approach 'Vectors' option assumes the pilot will receive vectors to the final course segment of the approach and will provide navigation guidance relative to the final approach course.)



Figure 6-3 Transitions Window

- 5) Turn the large **right** knob to highlight 'Load?' or 'Activate?' (approaches only) and press the **ENT** Key. ('Load?' adds the procedure to the flight plan without immediately using it for navigation guidance. This allows the pilot to continue navigating the original flight plan, but keeps the procedure available on the Active Flight Plan Page for quick activation when needed.)
- 6) For precision approaches and some non-precision approaches, a reminder window appears indicating that GPS guidance on such approaches is strictly for monitoring only; use the VLOC receivers and external CDI (or HSI) for primary navigation. To confirm this reminder, highlight 'Yes?' and press the **ENT** Key.

Not all approaches in the database are approved for GPS use. When selecting an approach, a 'GPS' designation to the right of the procedure name (Figure 6-4) indicates the procedure can be flown using the GPS receiver. Some procedures do not have this designation, meaning the GPS receiver may be used for supplemental navigation guidance only. ILS approaches, for example, must be flown by tuning the VLOC receiver to the proper frequency and coupling the VLOC receiver to the external CDI (or HSI).



Figure 6-4 'GPS' Designations

Once an approach is selected, it may be activated for navigation from the Procedures Page. Activating the approach overrides the 'enroute' portion of the active flight plan, proceeding directly to the 'approach' portion (for a full approach, directly to the initial approach fix). Activating the approach also initiates automatic CDI scaling transition as the approach progresses.

### To activate an approach:

- 1) Press the **PROC** Key to display the Procedures Page (Figure 6-5).
- 2) Turn the large **right** knob to highlight 'Activate Approach?' (Figure 6-5) and press the **ENT** Key.

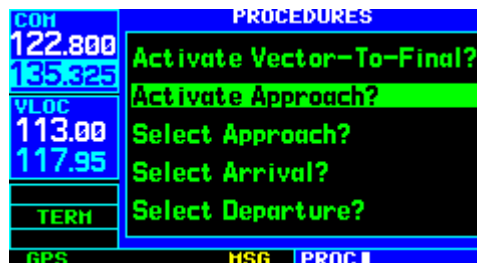

Figure 6-5 Procedures Page

Another Procedures Page option allows the pilot to activate the final course segment of the approach. This option assumes the pilot will receive vectors to the final approach fix (FAF) and provides guidance to intercept the final course, before reaching the FAF.

**To activate the approach, with vectors to final:**

- 1) Press the **PROC** Key to display the Procedures Page.
- 2) Turn the large **right** knob to highlight 'Activate Vector-To-Final?' (Figure 6-6) and press the **ENT** Key.

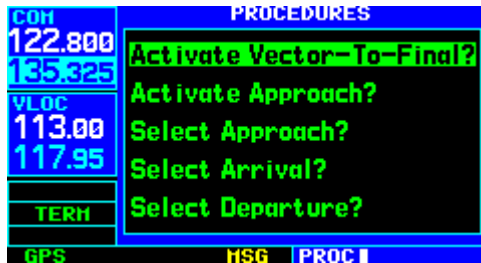

Figure 6-6 Procedures Page

In many cases, it may be easiest to 'Load' the full approach while still some distance away, enroute to the destination airport. Later, if vectored to final, use the steps above to select 'Activate Vector-To-Final'—which makes the inbound course to the FAF waypoint active. Otherwise, activate the full approach using the 'Activate Approach?' option.

## 6.2 NON-PRECISION APPROACH OPERATIONS

The GNS 430 provides non-precision approach guidance using its built-in GPS receiver. The GPS receiver can also be used as a supplemental aid for precision approaches, but the localizer and glideslope receivers *must* be used for primary approach course guidance.

Approaches designed specifically for GPS are often very simple and don't require overflying a VOR or NDB. Many non-precision approaches have 'GPS overlays' to let the pilot fly an existing procedure (VOR, VOR/DME, NDB, RNAV, etc.) more accurately using GPS.

Many overlay approaches are complex (in comparison to GPS-only approaches). The GNS 430 displays and provides guidance through each leg of the approach, automatically sequencing through each of these legs, up to the missed approach point (MAP). Approaches may be flown 'as published' with the full transition using any published feeder route or initial approach fix (IAF), or may be flown with a vectors-to-final transition.



**NOTE:** The following approach examples are intended for instructional use only and are not to be used for navigation.

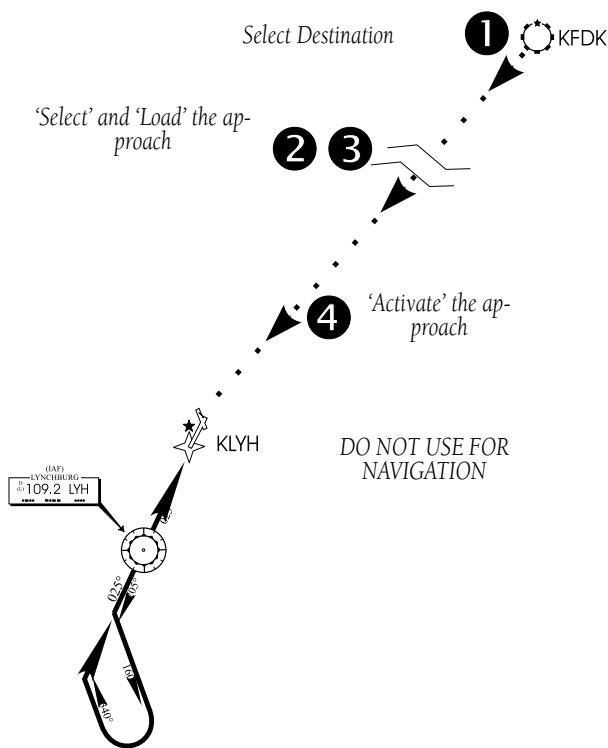

**Figure 6-7 Sample Approach**

Approach operations on the GNS 430 typically begin with the same basic steps (refer to Figure 6-7 for the following steps):

- 1) Select the destination airport using the **Direct-to** Key, or as the last waypoint in the active flight plan.
- 2) Choose the 'Select Approach?' option from the Procedures Page (Section 6.1) or from the Active Flight Plan Page Menu (Section 5.2, Active Flight Plan Options).
- 3) 'Load' the approach (often while enroute) in anticipation of its future use. This places the approach in the active flight plan, but retains course guidance in the enroute section until the approach is 'activated'.

- 4) 'Activate' the full approach or vectors-to-final, as appropriate. In some scenarios, it may be more convenient to immediately activate the approach and skip the 'Load' process outlined in the preceding step 3. The GNS 430 provides both options.

**Approaches with Procedure Turns**

The procedure turn portion of an approach is stored as one of the legs of the approach. For this reason, the GNS 430 requires no special operations from the pilot (other than flying the procedure turn itself) beyond what is required for any other type of approach.

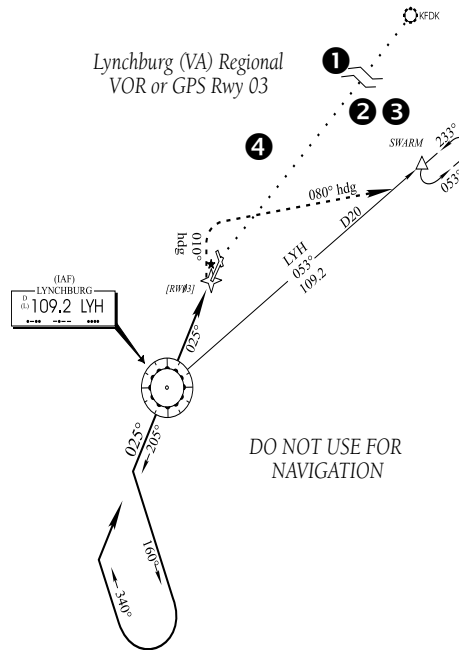

**Figure 6-8 Sample Approach with Procedure Turn**

This example uses the VOR Runway 03 approach for Lynchburg (Virginia) Regional Airport, KLYH, and assumes a departure from Frederick (Maryland) Municipal Airport, KFDK.

The steps required to set up and fly the approach are detailed below (refer to Figure 6-8 for the following steps):

- 1) Prior to departing KFDK, the destination (KLYH) is selected using the **Direct-to** Key or by creating a flight plan terminating at Lynchburg Regional.
- 2) While enroute to KLYH, select the ATIS frequency from the list on the NAV/COM Page (Section 3.6 and Figure 6-9) and place it in the standby field of the COM Window. Use the **COM Flip-flop** Key to make the ATIS frequency active.



Figure 6-9 NAV/COM Page

- 3) Press the **PROC** Key (Figure 6-10) and select the 'VOR 03' approach using the steps outlined in Section 6.1. From the Transitions Window (Figure 6-11), select LYH VOR (the IAF). Also, select 'Load?' to load, but not activate, the approach.

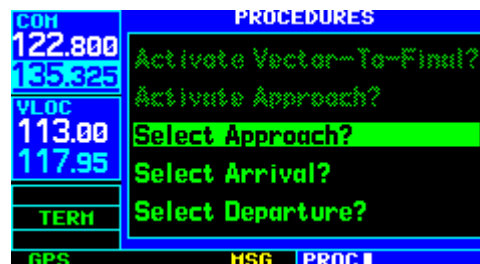

Figure 6-10 Procedures Page



Figure 6-11 Approach and Transitions Windows

- 4) Press the **PROC** Key, select 'Activate Approach?' and press the **ENT** Key to activate the approach.

**Flying the Procedure Turn**

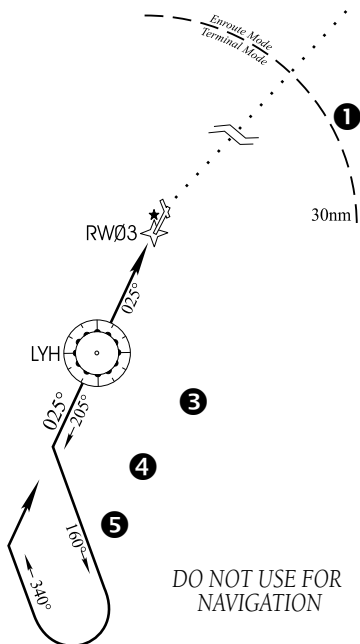

**Figure 6-12 Sample Approach with Procedure Turn**

Refer to Figure 6-12 for the following steps:

- 1) Within 30 nm of the destination airport, the GNS 430 switches from 'enroute' mode to 'terminal' mode (as indicated in the lower left corner of the screen). The switch to terminal mode is accompanied by a gradual Course Deviation Indicator (CDI) scale transition from 5.0 to 1.0 nm, full scale deflection (Figure 6-13).



**Figure 6-13 CDI Scale at 1.0 nm**

- 2) Several miles prior to reaching the IAF (LYH), the pilot may wish to review the approach sequence. Press the **FPL** Key to display the Active Flight Plan Page. Press the small **right** knob, and then turn the large **right** knob to review each segment of the approach (Figure 6-14). When finished, press the **FPL** Key again to return to the previous page.

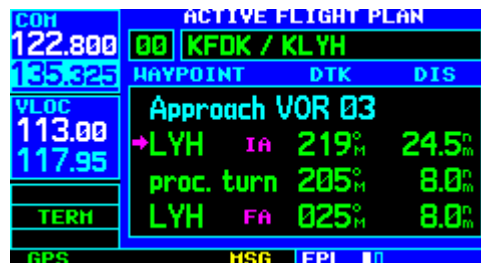

**Figure 6-14 Active Flight Plan Page**

- 3) When approaching the IAF (LYH), a waypoint alert ("NEXT DTK 205°") appears in the lower right corner of the screen (Figure 6-15). As the distance (DIS) to the IAF approaches zero, the alert is replaced by a turn advisory ("TURN TO 205°"). Dial the outbound course of 205° into the CDI (or HSI) using the OBS knob.





**Figure 6-15** Waypoint Alert

- 4) Fly the outbound course.
- 5) Approximately one minute after passing the FAF (LYH), the alert message 'START PROC TRN' appears in the lower right corner of the screen. Initiate the procedure turn at any time after receiving this alert message.

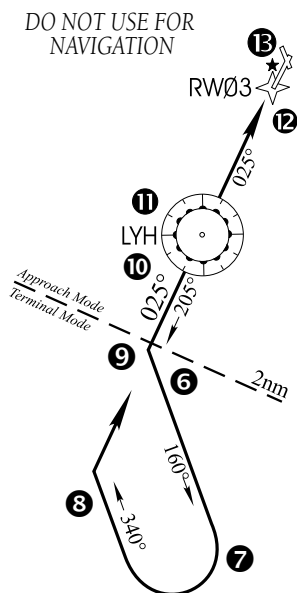

**Figure 6-16** Terminal Mode

Refer to Figure 6-16 for the following steps:

- 6) Course guidance is provided relative to the outbound leg from the FAF. No guidance through the procedure turn itself is given. (The procedure turn is displayed on the Map Page and indicated as the active leg on the Default NAV Page and the Active Flight Plan Page.) The CDI needle starts moving to the right.
- 7) When turning to intercept the inbound course, the GNS 430 sequences to the inbound leg to the FAF, the CDI needle swings to the opposite side to provide proper sensing along the final course segment and 'NEXT DTK 025°' appears in the lower right corner of the screen (Figure 6-17).



**Figure 6-17** Sequence to Inbound Leg

- 8) Turn to the final approach course.
- 9) Within 2.0 nm of the FAF (LYH), the GNS 430 switches from terminal mode to 'approach' mode. CDI scaling is tightened from 1.0 to 0.3 nm, full scale deflection.
- 10) When approaching the FAF, a waypoint alert ('NEXT DTK 026°') appears in the lower right corner. Make any course adjustments necessary for the final course segment (FAF to MAP).

- After crossing the FAF, the destination sequences to the MAP ('RW03', the runway threshold, see Figure 6-18). Fly toward the MAP.



**Figure 6-18 Sequence to MAP**



*NOTE: When viewing the Map Page, note that the final course segment is displayed in magenta (the active leg of the flight plan always appears in magenta) and a dashed line extends the course beyond the MAP. The dashed line is provided for situational awareness only and should NOT be used for navigation. Follow the published missed approach procedures.*

- When approaching the MAP, a waypoint alert ('APPRCHING WPT') appears in the lower right corner.
- After crossing the MAP, 'SUSP' appears above the **OBS** Key (Figure 6-19), indicating that automatic sequencing of approach waypoints is suspended at the MAP. A 'from' indication is displayed on the CDI and Default NAV Page, but course guidance along the final approach continues. If a missed approach is required, use the **OBS** Key to initiate the missed approach sequence, as outlined, beginning on the following page.



**Figure 6-19 'SUSP' Annunciation**

### Flying the Missed Approach

After passing the MAP, if the runway isn't in sight the pilot must execute a missed approach. The GNS 430 continues to give guidance along an extension of the final course segment (FAF to MAP) until the pilot manually initiates the missed approach procedure (as mentioned previously in reference to the 'SUSP' advisory).

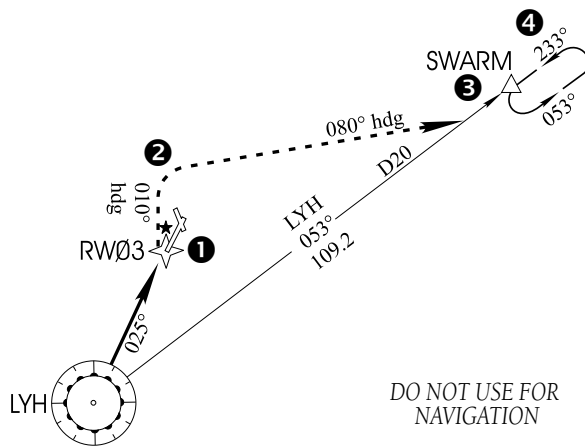

**Figure 6-20 Sequence to MAP**

The **OBS** Key is used to initiate the missed approach, as follows (refer to Figure 6-20 for the following steps):

- 1) Press the **OBS** Key. The missed approach holding point (MAHP; in this case 'SWARM' intersection) is automatically offered as the destination waypoint (Figure 6-21).

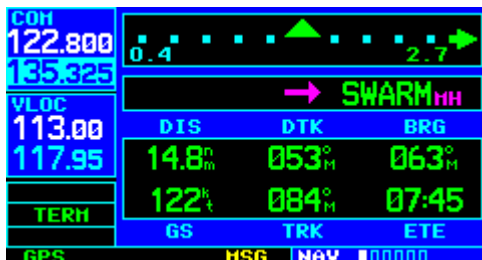

Figure 6-21 Missed Approach Holding Point

30° of the inbound course). This allows the pilot to use standard timing (typically one minute) to fly the inbound and outbound legs of the hold.



Figure 6-22 'Hold Teardrop' Annunciation



*NOTE: In some cases, an additional hold waypoint is added to the missed approach sequence. This additional waypoint is used as an aid in establishing the holding pattern, especially where the MAP and MAHP are the same waypoint.*

- 2) Follow the missed approach procedures, as published on the approach plate, for proper climb and heading instructions. The GNS 430 guides the pilot to the holding pattern, along the 053° radial from LYH VOR.
- 3) An alert message in the lower right-hand corner of the screen recommends entry procedures for the holding pattern (i.e., 'HOLD DIRECT', 'HOLD PARALLEL', or 'HOLD TEARDROP', see Figure 6-22). When flying the holding pattern, a timer appears on the Default NAV Page (Figure 6-23). The timer automatically resets on the outbound side of the hold when the aircraft is abeam the hold waypoint. The timer again resets as the aircraft turns inbound (within approximately



Figure 6-23 Hold Timer

- 4) The GNS 430 provides course guidance only on the inbound side of the holding pattern. When leaving the holding pattern to re-fly the approach (or another approach) press the **PROC** Key to 'Select Approach?' or 'Activate Approach?' as previously described. (Or, use the **Direct-to** Key to select another destination.)

**Flying an Approach with a Hold**

Starting where the previous example left off, assume weather conditions resulted in a missed approach at Lynchburg Regional. The pilot has decided to divert to Farmville Regional (KFBV) instead (refer to Figure 6-24 for the following steps).

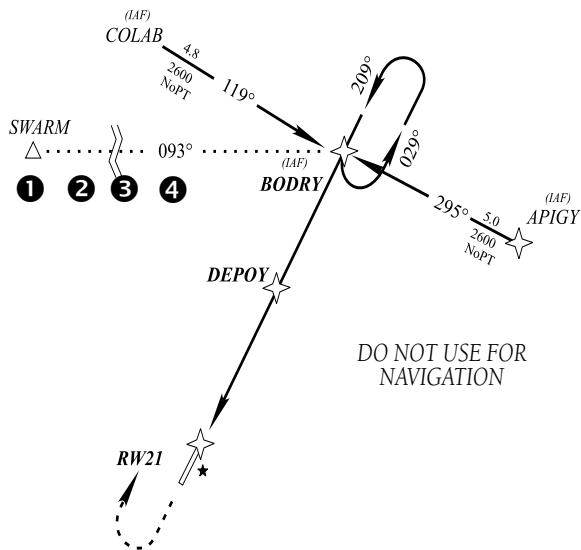

Figure 6-24 Approach with Hold

- 1) Press the **Direct-to** Key.
- 2) Use the small and large **right** knobs to enter the destination airport's identifier (KFBV) (Figure 6-25).

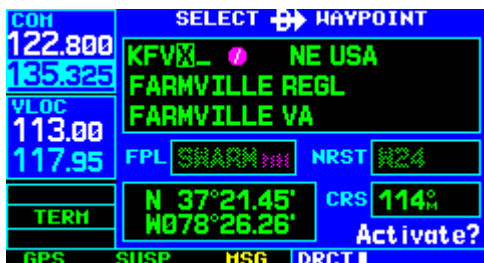

Figure 6-25 Select Direct-To Waypoint Page

- 3) Press the **ENT** Key twice.

This time, the pilot selects the GPS runway 21 approach into Farmville Regional. The GPS runway 21 approach begins with a holding pattern at the IAF, BODRY intersection.

- 4) Press the **PROC** Key and select the 'GPS 21' approach. (Figure 6-26, also Section 6.1 for additional instructions.)

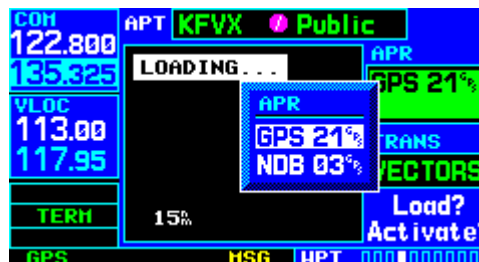

Figure 6-26 Approach Window

- 5) From the Transitions Window, select BODRY intersection as the IAF (Figure 6-27). Also, select 'Activate?' to load and activate the approach.

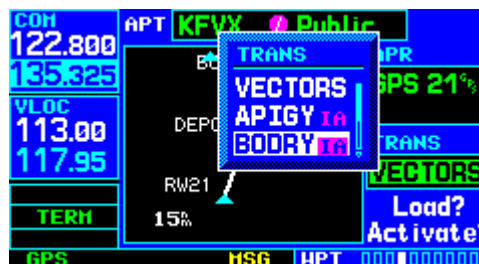

Figure 6-27 TRANS 'Transitions' Window

- 6) Once the approach has been activated, the Active Flight Plan Page appears (Figure 6-28). The pilot may review the approach sequence by pressing the small **right** knob and turning the large **right** knob. Press the **FPL** Key to return to the navigation pages.

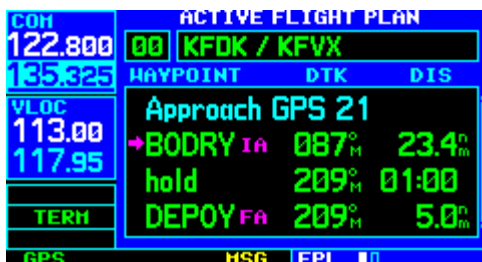

Figure 6-28 Active Flight Plan Page

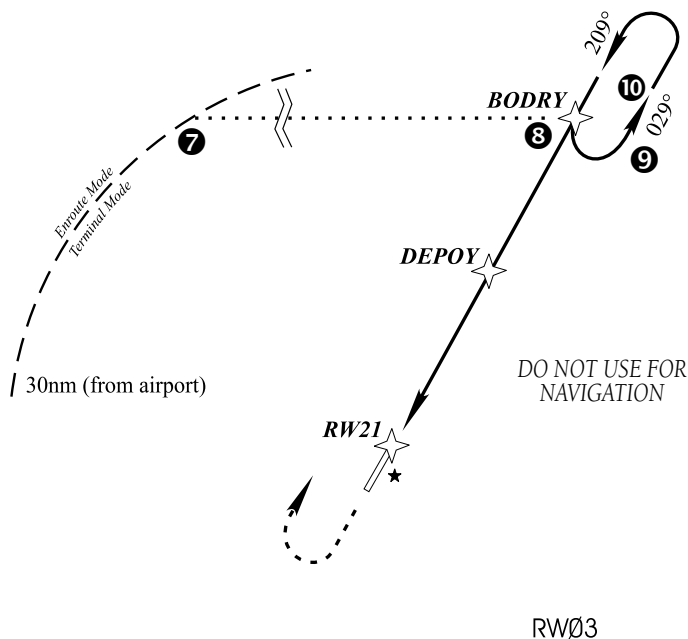

Figure 6-29 Terminal Mode

Refer to Figure 6-29 for the following steps.

- 7) As in the last example, within 30 nm of the airport, the GNS 430 switches from enroute to terminal mode, and the CDI scale transitions from 5.0 to 1.0 nm, full scale deflection.
- 8) Just prior to crossing BODRY intersection, a 'HOLD TEARDROP' alert appears in the lower right corner of the screen to suggest the proper

holding pattern entry (Figure 6-30). ('HOLD DIRECT' or 'HOLD PARALLEL' may be offered on other similar approaches.)



Figure 6-30 'HOLD TEARDROP' Annunciation

- 9) As mentioned in the missed approach example, the Default NAV Page displays a timer during the holding pattern (Figure 6-31). The timer can be used to fly the one minute outbound portion of the holding pattern. (The holding pattern is displayed on the Map Page and indicated as the active leg on the Default NAV Page and the Active Flight Plan Page.)

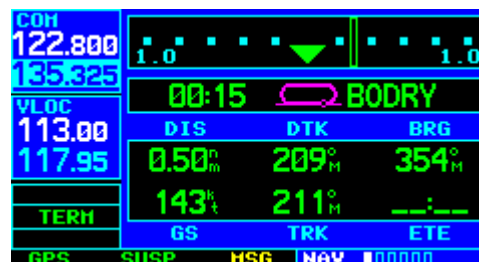

Figure 6-31 Default NAV Page

- 10) When crossing the IAF, 'SUSP' appears above the **OBS** Key (Figure 6-31), indicating that automatic sequencing of approach waypoints is temporarily suspended. As the aircraft turns inbound, 'SUSP' is cancelled and the GNS 430 returns to automatic sequencing.



**NOTE:** If the pilot needs to lose extra altitude or speed by going around the holding pattern again, press the **OBS** Key to manually suspend waypoint sequencing **BEFORE** crossing the holding waypoint the second time. If this waypoint has already been passed, re-activate the holding pattern using the steps described in Section 5.2.

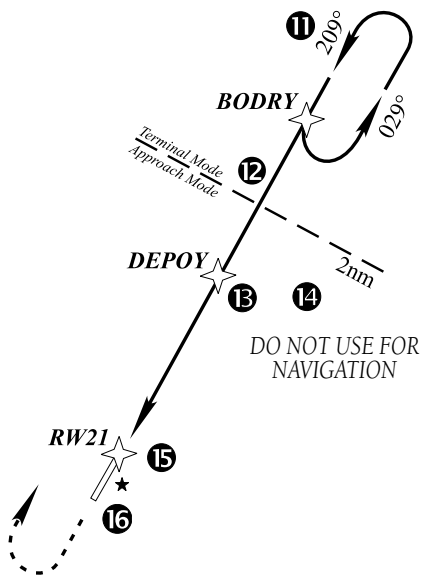

Figure 6-32 Approach Mode

Refer to Figure 6-32 for the following steps.

- 11) When approaching BODRY intersection, a waypoint alert ('NEXT DTK 209°') appears in the lower right corner of the screen (Figure 6-33).



Figure 6-33 Waypoint Alert

- 12) At 2.0 nm from the FAF (DEPOY intersection), the GNS 430 switches from terminal mode to approach mode. CDI scaling is tightened from 1.0 to 0.3 nm, full scale deflection.

- 13) When approaching the FAF, a waypoint alert ('NEXT DTK 209°') appears in the lower right corner (Figure 6-34). Make any course adjustments necessary for the final course segment (FAF to MAP).



Figure 6-34 Final Approach

- 14) After crossing the FAF, the destination sequences to the MAP ('RW21', the runway threshold). With the needle centered, fly toward the MAP, observing the altitude minimums dictated by the approach plate. When viewing the Map Page, note that the final course segment is displayed in magenta, (the active leg of the flight plan always appears in magenta) and a dashed line extends the course beyond the MAP. Do *not* follow this extended course. Instead, follow published missed approach procedures.

- 15) When approaching the MAP, a waypoint alert ('APPROCHING WPT') appears in the lower right corner.
- 16) After crossing the MAP, 'SUSP' appears above the **OBS** Key (Figure 6-35), indicating that automatic sequencing of approach waypoints is suspended at the MAP. A 'from' indication is displayed on the CDI and Default NAV Page, but course guidance along the final approach course continues. If a missed approach is required, use the **OBS** Key to initiate the missed approach sequence, as outlined in this section.

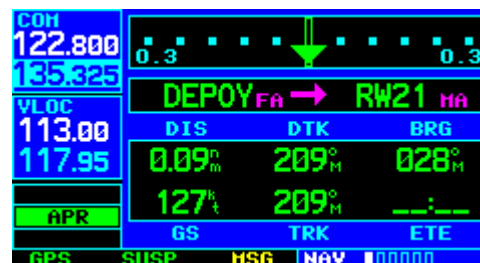

Figure 6-35 Missed Approach

## Flying a DME Arc Approach

The GPS overlay for a DME arc approach uses additional Jeppesen-provided waypoints to define the arc. These waypoints are indicated by ‘D’ as the first letter in the waypoint name. This is followed by three numbers which indicate the radial the waypoint lies on. The last letter indicates the radius of the arc.

Either of the following may be done to intercept the arc for a DME arc approach:

- Follow a specified radial inbound to intercept the IAF.
- Follow ATC vectors which allow the pilot to intercept the arc at any point along the arc.

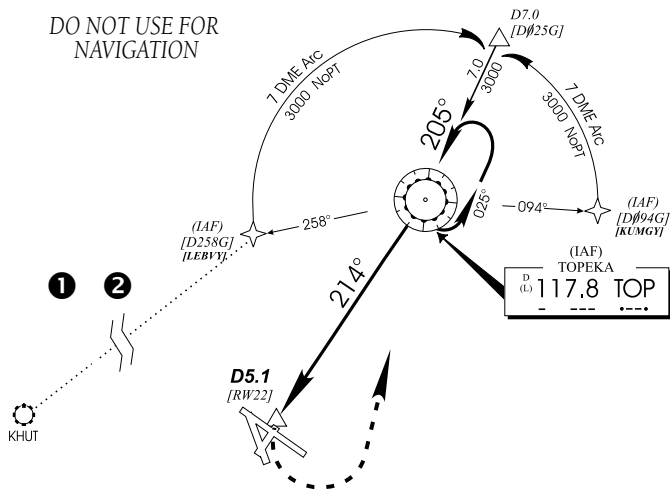

Figure 6-36 Enroute Mode



**NOTE:** As this manual was being written, the letter/number DME arc names were being replaced with standard five-letter intersection names. Either naming convention may be used for an approach.

This example is based upon a flight from Hutchinson (Kansas) Municipal (KHUT) to Billard Municipal (KTOP) in Topeka, Kansas. The VOR/DME runway 22 approach is selected, along with ‘D258G’ as the IAF (refer to Figure 6-36 for the following steps).

- 1) Select Billard Municipal (KTOP) as the destination via the **Direct-to** Key or as the last waypoint in a flight plan (Figure 6-37).

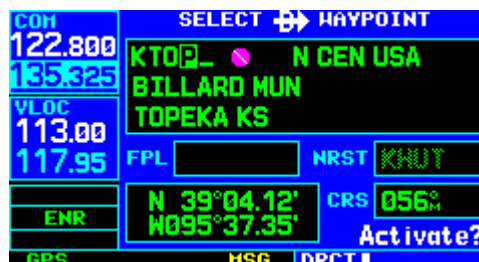

Figure 6-37 Select Waypoint Page

- 2) Press the **PROC** Key (Figure 6-38) and select the ‘VOR 22’ approach (Figure 6-39) using the steps outlined in Section 6.1. From the Transitions Window, select ‘D258G’ as the IAF. Also, select ‘Load?’ (or ‘Activate?’, if already cleared for the approach).



Figure 6-38 Procedures Page



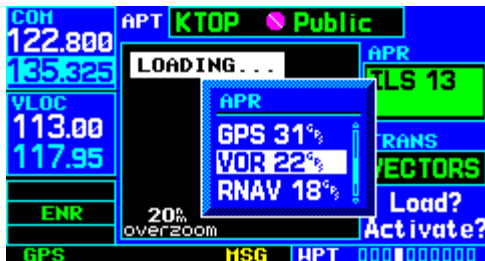

Figure 6-39 Approach Window

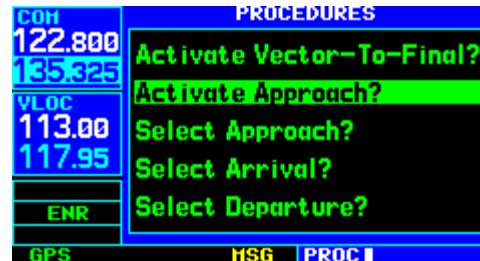

Figure 6-41 Procedures Page

DO NOT USE FOR  
NAVIGATION

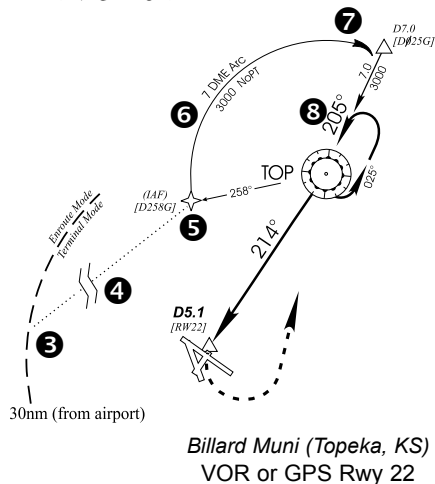

Figure 6-40 Terminal Mode

Refer to Figure 6-40 for the following steps.

- 3) Within 30 nm of KTOP, the GNS 430 switches from enroute mode to terminal mode and the CDI scale transitions from 5.0 to 1.0 nm, full scale deflection.
- 4) If the approach has not yet been activated (in step 2 above), do so when cleared for the approach (Figure 6-41).

- 5) When approaching the IAF (D258G), a waypoint alert ("NEXT DTK 353°") appears in the lower right corner of the screen (Figure 6-42). As the distance (DIS) to the IAF approaches zero, the alert is replaced by a turn advisory ("TURN TO 353°").



Figure 6-42 Waypoint Alert

- 6) Follow the arc, when the course select setting and desired track differ by more than 10°, a "Set course to ###°" message appears on the Message Page.

- 7) The next point in the approach is an intermediate fix, labeled 'D025G'. When approaching this intermediate fix, a waypoint alert ('NEXT DTK 205°') appears in the lower right corner of the screen (Figure 6-43). As the distance to this fix approaches zero, the alert is replaced by a turn advisory ('TURN TO 205°'). Dial this course into the CDI (or HSI) using the OBS knob.



Figure 6-43 Intermediate Approach Fix

- 8) At 2.0 nm from the FAF (TOP VOR), the GNS 430 switches from terminal mode to approach mode. CDI scaling is tightened from 1.0 to 0.3 nm, full scale deflection.

Refer to Figure 6-44 for the following steps.

DO NOT USE FOR  
NAVIGATION

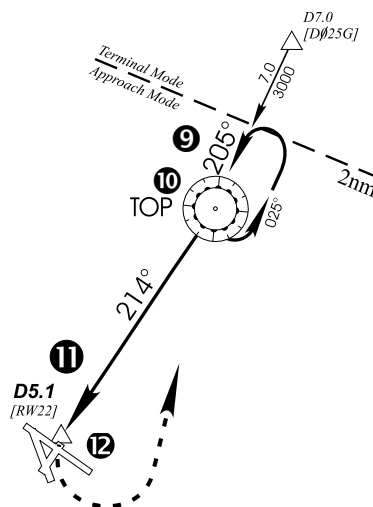

Figure 6-44 Approach Mode

- 9) When approaching the FAF, 'NEXT DTK 214°' appears in the lower right corner of the screen (Figure 6-45). Select this course on the CDI (or HSI) using the OBS knob.



Figure 6-45 Final Approach Fix

- 10) After crossing the FAF, the destination sequences to the MAP ('RW22', the runway threshold). With the needle centered, fly toward the MAP, observing the altitude minimums dictated by the approach plate. When viewing the Map Page, note that the final course segment is displayed in magenta (the active leg of the flight plan always appears in magenta) and a dashed line extends the course beyond the MAP (Figure 6-46).



Figure 6-46 Final Course Segment

- 11) When approaching the MAP, a waypoint alert ('APPRCHING WPT') appears in the lower right corner.
- 12) After crossing the MAP, 'SUSP' appears above the **OBS** Key (Figure 6-47), indicating that automatic sequencing of approach waypoints is suspended at the MAP. A 'from' indication is displayed on the CDI and Default NAV Page, but course guidance along the final approach course continues. Do *not* follow this extended course. Follow published missed approach procedures using the **OBS** Key to initiate the missed approach sequence, as outlined in 'Flying the Missed Approach' in this section.

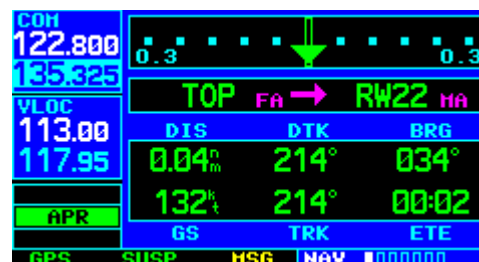

Figure 6-47 'SUSP' Annunciation

## Vectors to Final

Take a second look at the 'VOR 22' approach into Billard Municipal. Instead of following the DME arc, ATC tells the pilot to expect vectors onto the final approach course. There are several ways to select 'vectors to final' with the GNS 430. The first two options below normally require the least workload to accomplish:

- When the approach is first selected, choose 'VECTORS' from the Transitions Window.
- Load a full approach (including the IAF from the Transitions Window) as described in Section 6.1. When cleared, press the **PROC** Key and select 'Activate Vectors-To-Final?.'
- Load the full approach as described in Section 6.1. Use the **Direct-to** Key (by pressing it twice) from the Active Flight Plan Page to select the desired leg of the approach.

## To select 'VECTORS' from the Transitions Window:

- 1) Select Billard Municipal (KTOP) as the destination, using the **Direct-to** Key, or as the last waypoint in a flight plan.
- 2) Press the **PROC** Key and select the 'VOR 22' approach using the steps outlined in Section 6.1.
- 3) From the Transitions Window, select 'VECTORS' (Figure 6-48).

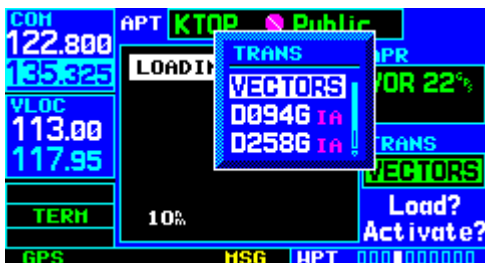

Figure 6-48 Transitions Window

- 4) Select 'Load?' (or 'Activate?', if already cleared for the approach).

## To activate vectors-to-final from the Procedures Page:

- 1) Select Billard Municipal (KTOP) as the destination, using the **Direct-to** Key or as the last waypoint in a flight plan.
- 2) Press the **PROC** Key and select the 'VOR 22' approach using the steps outlined in Section 6.1.

- 3) From the Transitions Window, select 'D258G' as the IAF (Figure 6-49). Also, select 'Load?'.



Figure 6-49 Transitions Window

- 4) When cleared, press the **PROC** Key and select 'Activate Vector-To-Final?' (Figure 6-50).

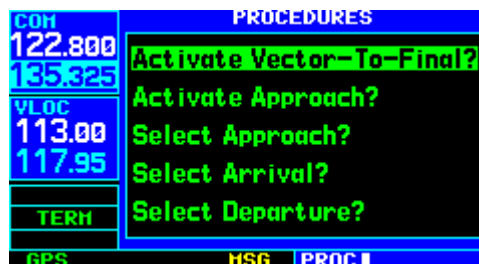
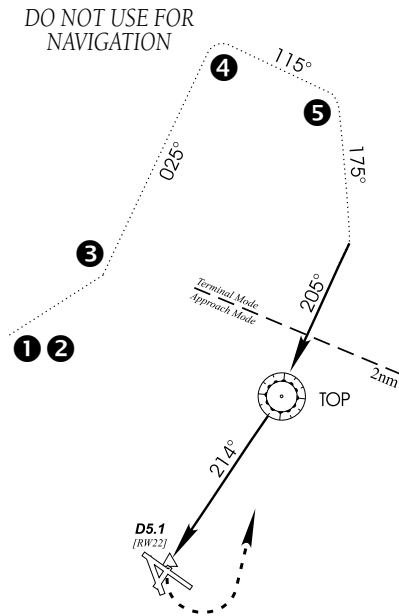

Figure 6-50 Procedures Page

## Flying the Vectors Approach

With 'vectors to final' selected, the CDI needle remains off center until the aircraft is established on the final approach course. With the approach activated, the Map Page displays an extension of the final approach course in magenta (magenta is used to depict the active leg of the flight plan) and 'VTF' appears as part of the active leg on the Default NAV Page (as a reminder that the approach was activated with vectors-to-final).



**Figure 6-51 Terminal Mode**

In this example, assume ATC vectors result in a rectangular course to intercept final, as follows (refer to Figure 6-51 for the following steps):

- 1) Within 30 nm of KTOP, the GNS 430 switches from enroute mode to terminal mode and the CDI scale transitions from 5.0 to 1.0 nm, full scale deflection.
- 2) If the approach has not already been activated, activate the approach (with vectors-to-final). This allows the GNS 430 to provide guidance to the final approach course.
- 3) ATC instructs the pilot to turn left to a heading of 025°. This places the aircraft parallel to the final approach course in the opposite direction (Figure 6-52). CDI needle deflection is to the left.



**Figure 6-52 Heading of 025°**

- 4) ATC instructs the pilot to turn right to a heading of 115° (Figure 6-53).



**Figure 6-53 Heading of 115°**

- 5) ATC instructs the pilot to turn right to a heading of 175° to intercept the final approach course. When converging with the final approach course the needle moves toward the center. (In Figure 6-54, the needle has not yet returned to the on-screen CDI, since the current position is still 1.7 nm right of the final approach course.)



**Figure 6-54 CDI Off Scale**

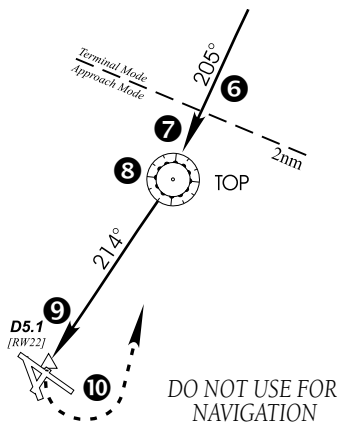

Figure 6-55 Approach Mode

Refer to Figure 6-55 for the following steps.

- 6) At 2.0 nm from the FAF (TOP VOR), the GNS 430 switches from terminal mode to approach mode (Figure 6-56). CDI scaling is tightened from 1.0 to 0.3 nm, full scale deflection.



Figure 6-56 Approach Mode

- 7) When approaching the FAF, a waypoint alert ('NEXT DTK 214°') appears in the lower right corner (Figure 6-57).



Figure 6-57 Waypoint Alert

- 8) When crossing the FAF, the destination sequences to the MAP ('RW22').
- 9) When approaching the MAP, a waypoint alert ('APPRCHING WPT') appears in the lower right corner.
- 10) After crossing the MAP, 'SUSP' appears above the **OBS** Key (Figure 6-58), indicating that automatic sequencing of approach waypoints is suspended at the MAP. A 'from' indication is displayed on the CDI and Default NAV Page, but course guidance along the final approach course continues. Do *not* follow this extended course. Follow published missed approach procedures using the **OBS** Key to initiate the missed approach sequence, as outlined in this section.



Figure 6-58 Final Approach

### Course From Fix Flight Plan Legs

Certain approach, departure, and arrival procedures in the Jeppesen database contain course from fix flight plan legs. The GNS 430 is able to load these legs into the flight plan along with the rest of the procedure data, and provide navigation along these legs.

There are three different types of course from fix legs:

- Course from fix to distance, or Course from fix to DME distance
- Course from fix to altitude
- Course from fix to manual sequence

Course from fix to distance legs appear in the flight plan like normal waypoints, but the destination name always begins with a 'D', followed by a distance in nm from the waypoint fix (Figure 6-59).

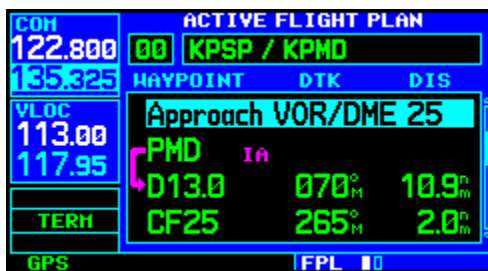

Figure 6-59 Active Flight Plan Page

This example uses the VOR/DME RWY 25 approach into Palmdale, California (KPMD) and includes a teardrop course reversal (refer to Figure 6-60 for the following steps).

- 1) At the initial approach fix (PMD), a waypoint alert ('NEXT DTK 070°') appears in the lower right corner of the screen. As the distance to the IAF approaches zero, the alert is replaced by a turn advisory ('TURN TO 070°'). Dial the outbound course into the CDI (or HSI) using the OBS knob.
- 2) Fly the 'course from fix to distance' leg, as shown on the Active Flight Plan Page and the Default NAV Page (Figures 6-61 and 6-62). Note the magenta line in Figure 6-62, which represents the currently active leg of the approach. The distance (DIS) displayed on the above screens is TO the 'D13.0' point. The flight plan automatically sequences to the next leg upon reaching 'D13.0'.



Figure 6-61 Default NAV Page

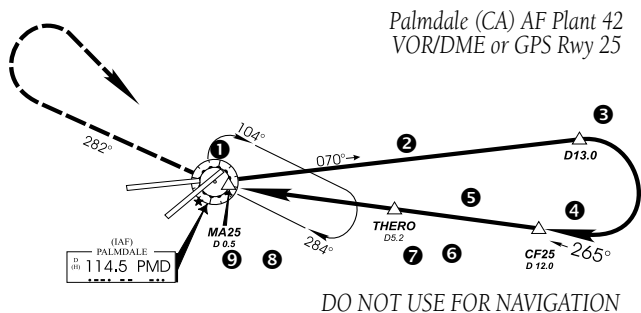

Figure 6-60 KPMD Approach



Figure 6-62 Map Page

- 3) At 13.0 nm from the FAF, a waypoint alert ('NEXT DTK 265°') appears in the lower right corner of the screen. Turn to intercept the final approach course and watch for the CDI needle to begin to center.
- 4) When approaching the intermediate fix (CF25), a waypoint alert ('NEXT DTK 265°') appears.
- 5) Within 2.0 nm of the FAF (THERO), the GNS 430 switches from terminal mode to approach mode. ('APR' appears in the lower left corner of the screen—replacing 'TERM'.) CDI scaling is tightened from 1.0 to 0.3 nm, full scale deflection.
- 6) When approaching the FAF, 'NEXT DTK 265°' appears in the lower right corner of the screen.
- 7) After crossing the FAF, the destination sequences to the MAP (MA25).
- 8) When approaching the MAP, a waypoint alert ('APPRCHING WPT') appears in the lower right corner of the screen.
- 9) After crossing the MAP, 'SUSP' appears above the **OBS** Key, indicating that automatic sequencing of approach waypoints is suspended at the MAP. If a missed approach is required, use the **OBS** Key to initiate the missed approach sequence, as outlined below.

Course from fix to altitude legs show the specific target altitude on the Active Flight Plan Page (Figure 6-63) and the Default NAV Page (Figure 6-64). The missed approach sequence for the Palmdale VOR/DME RWY 25 approach includes a course from fix to altitude leg.

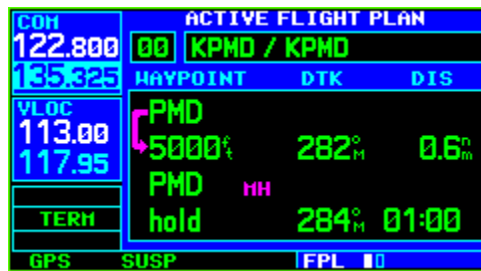

Figure 6-63 Active Flight Plan Page

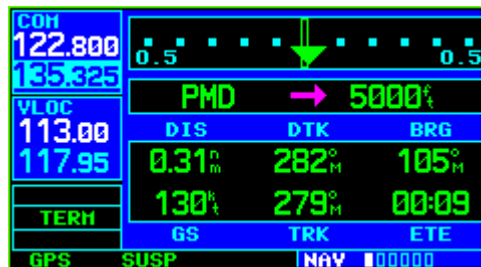
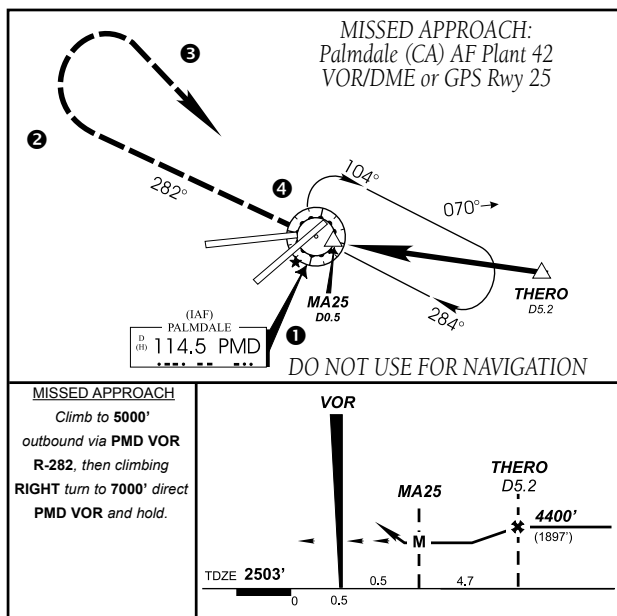

Figure 6-64 Default NAV Page





**Figure 6-65 Palmdale Missed Approach**

In this instance, the leg corresponds to the initial phase of the missed approach, which reads 'Climb to 5000' outbound via PMD VOR R-282'. Refer to Figure 6-65 for the following steps.

- 1) After crossing the MAP, press the **OBS** Key. The missed approach sequence is automatically offered, starting with the course from fix to altitude leg. The 'NEXT DTK 282°' alert appears in the lower right corner of the screen.
- 2) Note that within a few seconds of pressing the **OBS** Key to release suspend mode and start the approach sequence, 'SUSP' re-appears above the **OBS** Key as the GNS 430 returns to suspend mode. This is normal when flying a course from fix to altitude leg and indicates that automatic leg sequencing is suspended.

- 3) Fly the outbound course. The Map Page depicts the flight path extending indefinitely from PMD VOR (Figure 6-66). The distance (DIS) on the Default NAV Page, the Map Page, and the Active Flight Plan Page increases, indicating the distance back to PMD VOR.



**Figure 6-66 Map Page**

- 4) Upon reaching the desired altitude (5000'), press the **OBS** Key to return to automatic leg sequencing. Confirm that 'SUSP' no longer appears directly above the **OBS** Key.
- 5) An alert ('NEXT DTK 126°') appears, providing guidance to the inbound course (Figure 6-67). The actual desired track (DTK) depends on ground speed and distance from PMD VOR. Intercept and fly the inbound course.



**Figure 6-67 Waypoint Alert**

- 6) When approaching PMD VOR (the missed approach holding point), an alert message in the lower right-hand corner of the screen recommends the holding pattern entry procedure ('HOLD PARALLEL'). When flying the holding pattern, a timer appears on the Default NAV Page. The timer automatically resets on each outbound and inbound portion of the holding pattern.
- 7) Note that the GNS 430 again displays 'SUSP' above the **OBS** Key. Automatic waypoint sequencing is suspended at the missed approach holding point. A waypoint alert ('APPRCHING WPT') appears in the lower right corner of the screen each time the aircraft approaches PMD VOR in the holding pattern.
- 8) When leaving the holding pattern, press the **PROC** Key to reactivate the approach, or select a different approach, or press the **Direct-to** Key to select another destination.

Course from fix to manual sequence legs appear on the Active Flight Plan Page and the Map Page with 'man seq' in place of a waypoint identifier. An example of this type of course leg appears in the COASTAL ONE DEPARTURE from Westfield, Massachusetts (Barnes Muni). The example leg corresponds to the departure leg from Barnes Municipal and appears (as in Figure 6-68) on the Active Flight Plan Page and the Default NAV Page:

### COASTAL ONE DEPARTURE (CSTL1.CCC)

**DEPARTING BARNES MUNI,**  
Fly assigned heading and altitude for radar vectors to HFD VOR. Expect clearance to requested flight level 10 minutes after departure. From over HFD VOR, proceed via the HFD R-143 to Thumb Int, then via the HTO R-010 to Yoder Int, then via the CCC R-057 to CCC VOR. Then via transition or assigned route.

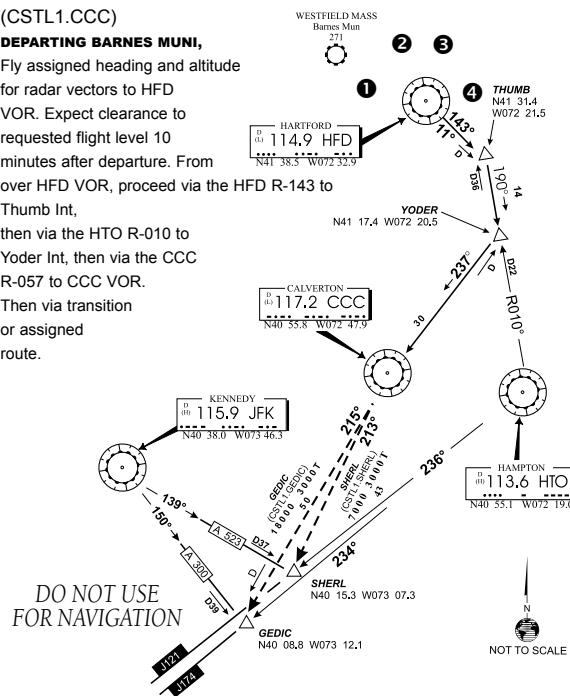

Figure 6-68 Coastal One Departure

Refer to Figure 6-68 for the following steps.

- 1) Select the departure (CSTL1) from the Procedures Page, then select the departure runway, (RW02 in this example, see Figure 6-69) and transition (GEDIC). Refer to Section 6.1 for instructions on selecting departures.



Figure 6-69 Runway Window

- 2) When departing the airfield, 'NEXT DTK 026°' appears in the lower right corner of the screen and 'SUSP' appears directly above the **OBS** Key, which indicates the aircraft is now on the 'course from fix to manual sequence' leg. The distance displayed on the Active Flight Plan Page, the Default NAV Page (Figure 6-70), and the Map Page is FROM the waypoint fix (the departure runway in this example).



Figure 6-70 Default NAV Page

- 3) Fly the outbound course. When cleared to sequence to the next leg, press the **OBS** Key. Confirm that 'SUSP' no longer appears directly above the **OBS** Key. An alert ('NEXT DTK 186°') appears in the lower right corner of the screen (Figure 6-71) to provide guidance to the next waypoint (HFD VOR). The actual desired track (DTK) depends on ground speed and distance from HFD VOR.



Figure 6-71 Waypoint Alert

- 4) When the **OBS** Key is pressed, the GNS 430 automatically sequences to each waypoint along the remainder of the departure route, including the selected transition.

### 6.3 ILS APPROACHES

Precision approaches can be performed with the GNS 430's built-in VLOC (VOR/localizer/glideslope) receivers. The GPS receiver can be used for guidance prior to reaching the final approach fix, but once there, the proper frequency must be selected on the VLOC Window (left side of screen) and the CDI output set to 'VLOC'.

The GNS 430 can be set to automatically switch the external CDI output from GPS to VLOC as the pilot intercepts the final approach course. When the ILS approach is activated, the GNS 430 automatically switches within 1.2 nm left or right of the final approach course. This switch can take place anywhere from 2.0 to 15.0 nm from the FAF.



*NOTE: When intercepting the approach course at a distance less than 2.0 nm from the FAF, the GNS 430 does not automatically switch the CDI to VLOC. In this case, press the **CDI** Key to manually switch from GPS to VLOC.*

Figure 6-72 shows multiple locations along the approach path and the expected CDI selection: GPS or VLOC. The automatic switch from GPS to VLOC should occur within the area of the shaded box.

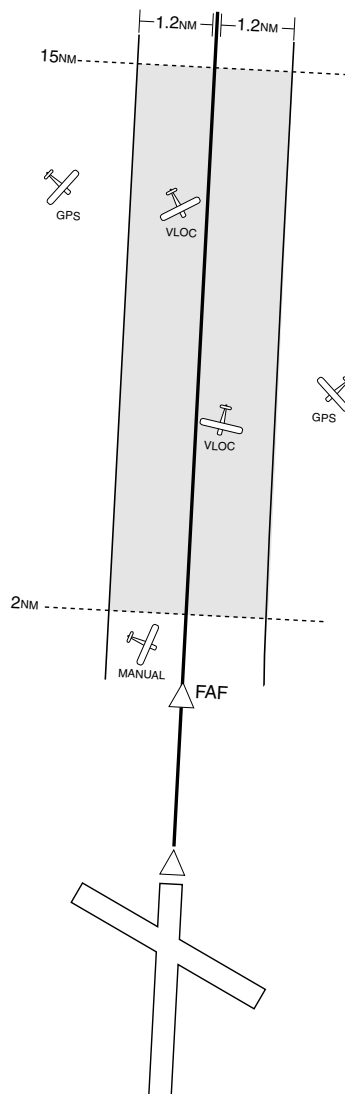
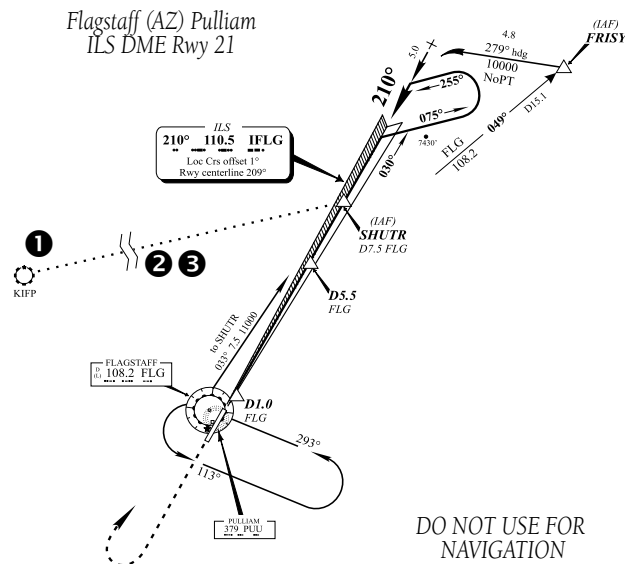

**Figure 6-72 ILS Approach**

The automatic switch from GPS to VLOC occurs gradually to prevent abrupt CDI changes when coupled to an autopilot. The CDI selection can also be changed manually by pressing the **CDI** Key. Once the switch from GPS to VLOC has occurred, either automatically or manually, it does not automatically switch again until the approach is reactivated or another approach is selected. To prevent automatic ILS CDI selection, choose the 'Manual' ILS CDI setting, as described in Section 10.4 'CDI Scale/Alarms'. (The factory default setting is 'Auto', which enables the automatic switch to VLOC.)

### Selecting an ILS Approach

This example uses a flight from Laughlin Bullhead (Arizona) International to Flagstaff Pulliam (KFLG) and selects the ILS runway 21 approach. 'SHUTR' intersection is selected as the IAF, which includes an outbound leg and a procedure turn. Of course, vectors-to-final could also be selected, as previously described for the non-precision approach examples (refer to Figure 6-73 for the following steps).



**Figure 6-73 ILS Approach, Flagstaff**

- 1) Select Flagstaff Pulliam (KFLG) as the destination, using the **Direct-to** Key or as the last waypoint in a flight plan (Figure 6-74).

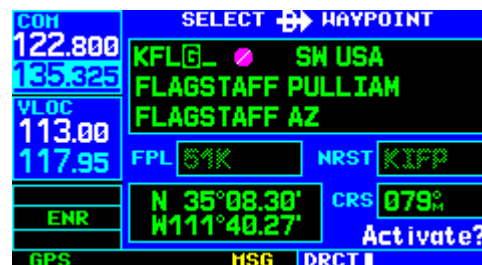

**Figure 6-74 Select Waypoint**

- 2) Press the **PROC** Key and select the 'ILS 21' approach (Figure 6-75) using the steps outlined in Section 6.1.

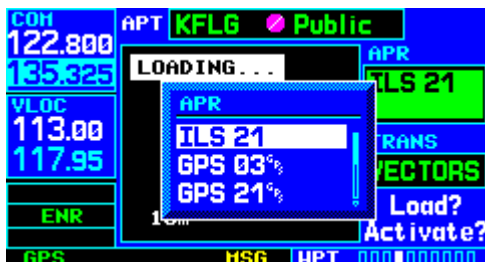

**Figure 6-75 Approach Window**

- 3) From the Transitions Window, select 'SHUTR' as the IAF (Figure 6-76). Also, select 'Load?' (or 'Activate?', if already cleared for the approach).



**Figure 6-76 Transitions Window**

- 4) A reminder message appears, indicating that GPS can only be used for approach monitoring. As mentioned, the VLOC receiver must be used for this approach. Press the **ENT** Key to acknowledge the message.

When an ILS approach is loaded or activated, the ILS frequency is automatically placed in the standby field of the VLOC Window. To use this frequency, press the **VLOC Flip-flop** Key to place it in the active frequency field.

## Flying the ILS Approach

When 'Activate?' is selected for an ILS approach, automatic switching of the external CDI is enabled (unless turned off from the CDI/Alarms Page). Once established on the inbound course to the FAF, the external CDI guidance automatically switches from 'GPS' (shown in green text) to 'VLOC' (shown in white text). If the pilot has forgotten to activate the ILS frequency (step 4 below), automatic selection of 'VLOC' does not occur (refer to Figure 6-77 for the following steps).

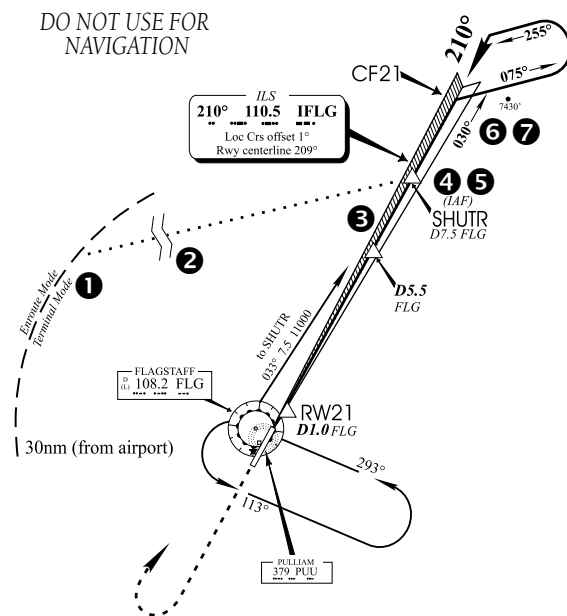

**Figure 6-77 Terminal Mode**

- 1) Within 30 nm of KFLG, the GNS 430 switches from enroute mode to terminal mode and the CDI scale transitions from 5.0 to 1.0 nm, full scale deflection.
- 2) If the approach has not yet been activated, (in steps on the preceding page), do so when cleared for the approach (Figure 6-78).
- 4) Press the **VLOC Flip-flop** Key to activate the ILS frequency. If this step is forgotten, the GNS 430 displays a reminder message (within 3 nm of the FAF) to activate the ILS frequency.
- 5) As the distance (DIS) to the IAF approaches zero, the alert is replaced by a turn advisory ('TURN TO 030°'; see Figure 6-80).

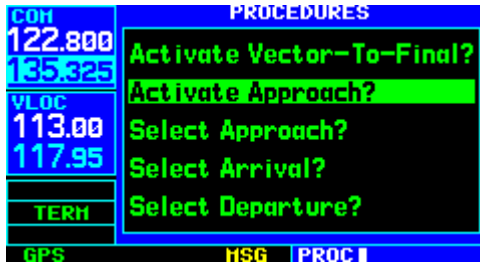

Figure 6-78 Activate Approach



Figure 6-80 Turn Advisory

- 3) When approaching the IAF (SHUTR), a waypoint alert ('NEXT DTK 030°') appears in the lower right corner of the screen (Figure 6-79).

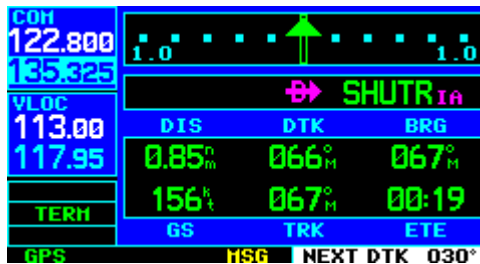
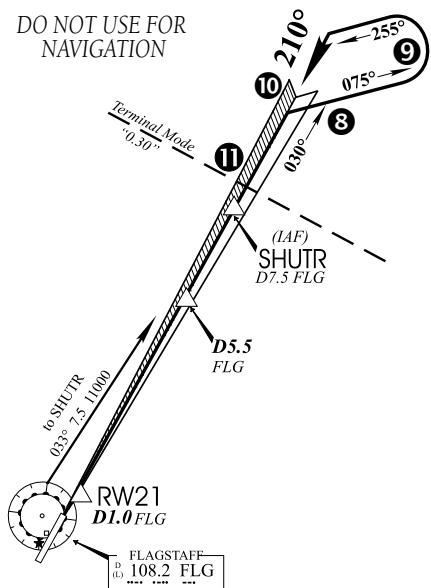

Figure 6-79 Waypoint Alert

- 6) Fly the outbound course.
- 7) Approximately one minute past SHUTR intersection, the alert message 'START PROC TRN' (Figure 6-81) appears in the lower right corner of the screen (if the pilot has not yet begun the procedure turn).



Figure 6-81 Alert Message



**Figure 6-82 ILS Approach Course**

Refer to Figure 6-82 for the following steps.

- 8) Initiate the procedure turn. The GNS 430 does not provide guidance through the turn. (The procedure turn is displayed on the Map Page and indicated as the active leg on the Default NAV Page and the Active Flight Plan Page.)
- 9) After approximately one minute, make a turn to intercept the ILS. The GNS 430 sequences to the inbound leg and 'NEXT DTK 210°' (Figure 6-83) appears in the lower right corner of the screen. CDI coupling automatically switches from the GPS receiver to the VLOC receiver as the pilot completes the inbound turn. (If the ILS frequency has not been activated, per step 4, this automatic CDI switching does not occur.)



**Figure 6-83 Waypoint Alert**

- 10) Turn to track the ILS approach course.



*NOTE: From this point on, primary navigation is provided by the VLOC receiver. The pilot may continue to use the GPS receiver for supplemental navigation guidance only. ALSO, when using an external CDI (not an HSI), expect reverse sensing when flying outbound on the approach course or when flying a backcourse approach.*

- 11) When approaching the FAF (SHUTR), '0.30nm' appears in the lower left corner of the screen indicating a CDI scale transition from 1.0 to 0.3 nm, full scale deflection (Figure 6-84). (This scale transition applies only to the Default NAV Page's on-screen CDI, since the external CDI or HSI is now coupled to the VLOC receiver. GPS approach mode is not activated for precision approaches, since the VLOC receiver must be used for primary navigation.)



**Figure 6-84 Final Approach**



DO NOT USE FOR  
NAVIGATION

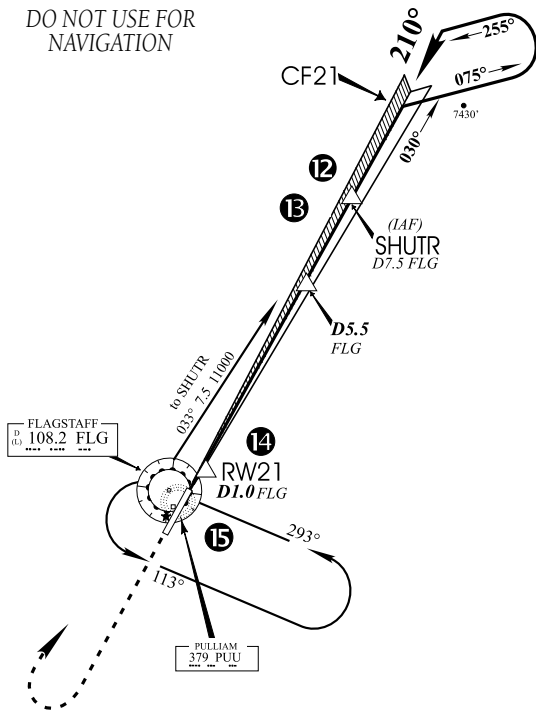

Figure 6-85 Final Approach, Flagstaff

Refer to Figure 6-85 for the following steps.

- 12) When approaching SHUTR, a waypoint alert ('NEXT DTK 210°') appears in the lower right corner of the screen (Figure 6-84).
- 13) After crossing SHUTR, the destination sequences to the MAP ('RW21', the runway threshold, see Figure 6-86). Fly toward the MAP. (When viewing the Map Page as in Figure 6-87, note that the final course segment is displayed in magenta (the active leg of the flight plan always appears in magenta), and a dashed line extends the course beyond the MAP.)



Figure 6-86 Default NAV Page



Figure 6-87 Map Page

- 14) When approaching the MAP, a waypoint alert ('APPROCHING WPT') appears in the lower right corner.

- 15) After crossing the MAP, 'SUSP' appears above the **OBS** Key (Figure 6-88), indicating that automatic sequencing of approach waypoints is suspended at the MAP. A 'FROM' indication is displayed on the CDI and Default NAV Page, but course guidance along the final approach course continues. Do not follow this extended course. Follow published missed approach procedures, using the **OBS** Key to initiate the missed approach sequence.



Figure 6-88 'SUSP' Annunciation



*NOTE: In addition to using the **OBS** Key to initiate the missed approach sequence, the **CDI** Key may be used to manually switch the external CDI output to the GPS receiver. 'GPS' is indicated above the **CDI** Key. If the pilot leaves the CDI output on 'VLOC' and the pilot is using an external CDI (not an HSI), expect reverse sensing on the backcourse of the ILS.*

## 6.4 POINTS TO REMEMBER FOR ALL APPROACHES

- The GNS 430 is designed to complement printed approach plates and vastly improve situational awareness throughout the approach. However, the pilot must always fly an approach as it appears on the approach plate.
- The active leg (or the portion of the approach currently in use) is depicted in magenta on the Map Page. When flying the approach, the GNS 430 automatically sequences through each leg of the approach unless 'SUSP' appears above the **OBS** Key. 'SUSP' indicates that automatic sequencing of approach waypoints is suspended on the current leg and normally appears at holding patterns and upon crossing the missed approach point (MAP).

## Points to Remember for Localizer-based Approaches

- The default factory setting allows the CDI output to automatically switch from the GPS receiver to the VLOC receiver. If the 'ILS CDI Capture' setting is changed to 'Manual', the pilot must determine when to select GPS or VLOC guidance during the approach. Remember, VLOC is required for the final course segment from final approach fix (FAF) to MAP.
- If the CDI output has not automatically switched from GPS to ILS by 2.0 nm prior to the FAF, the pilot must manually switch to the VLOC receiver by pressing the **CDI** Key. Verify that 'VLOC' is displayed directly above the **CDI** Key.
- Automatic switching of CDI output is available for ILS, localizer, SDF, and LDA approaches. Automatic CDI switching is not available for backcourse approaches.
- When flying an approach with the autopilot coupled, the pilot must monitor system functions at all times and verify that the autopilot and external CDI (or HSI) switches to the VLOC receiver with sufficient time to capture and track the approach course. Switching to VLOC late in the approach may not provide the autopilot enough time to respond and intercept the approach course prior to the FAF (depending upon the performance characteristics of the autopilot and aircraft). In such cases, the pilot should manually fly the approach or refer to the documentation provided with the autopilot.
- When an ILS approach is first selected and 'loaded' (or 'activated'), the ILS frequency is automatically placed in the standby field. In order to fly the final course segment of the ILS approach, the pilot must place the ILS frequency in the active frequency field by pressing the **VLOC Flip-flop** Key. If this is not done, a 'Select appropriate frequency for approach' message appears within 3.0 nm of the FAF.
- When flying a localizer-based approach (other than backcourse) with automatic CDI switching enabled:
  - ◆ GPS guidance is used while flying outbound and on the initial portion of the procedure turn.
  - ◆ VLOC guidance is used on the remainder of the approach from the time the pilot turns inbound on the procedure turn.
  - ◆ The localizer frequency must be active to use VLOC guidance.
- When flying a localizer-based approach with automatic CDI switching disabled:
  - ◆ The pilot may select VLOC guidance at any point on the approach prior to reaching the FAF.
  - ◆ The localizer frequency must be active to use VLOC guidance.

Blank Page

## SECTION 7: WPT PAGES

## 7.1 WPT PAGE GROUP

Section 3.1 introduced the GNS 430's main page groups (Table 7-1)—NAV, WPT, AUX, NRST—and described each page in the NAV group. This second page group (WPT) provides information for the thousands of airports, VORs, NDBs, intersections, runways, frequencies, and procedures stored on the Jeppesen NavData card. A WPT page is also provided to display information for up to 1,000 user-created waypoints.

| Page Groups   |              |                |               |
|---------------|--------------|----------------|---------------|
| NAV Group     | WPT Group    | AUX Group      | NRST Group    |
| see Section 3 | 10 WPT Pages | see Section 10 | see Section 8 |

Table 7-1 Page Groups

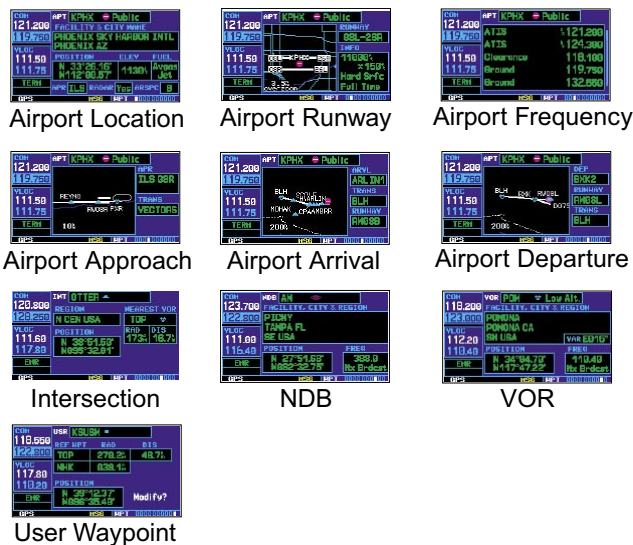

Figure 7-1 WPT Pages

To quickly select a WPT page:

- 1) From any page, press and hold the **CLR** Key to select the Default NAV Page (this step may be skipped if the unit is already displaying any of the main pages.)
- 2) Turn the large **right** knob to select the WPT Page Group. 'WPT' appears in the lower right corner of the screen.
- 3) Turn the small **right** knob to select the desired WPT page.



**NOTE:** The GNS 430 uses International Civil Aviation Organization (ICAO) identifiers for all airports. All U.S. airport identifiers which contain only letters use the prefix 'K'. For example, Los Angeles International is KLAX under the ICAO standard. Other airports, such as Otten Memorial (3VS), that contain numbers in the identifier, do not require the 'K' prefix. Many foreign countries use two letter prefixes.

The WPT Page Group includes ten pages (Figure 7-1). While viewing any WPT page, turn the small **right** knob to select a different WPT page. The first six pages provide detailed information for the selected airport: location, runways, frequencies, approaches, arrivals, and departures. The last four pages provide information for intersections, NDBs, VORs, and user-created waypoints.

After a WPT page is selected, information for a waypoint may be viewed by entering the identifier (or name) of the desired waypoint. Airports, NDBs, and VORs may be selected by identifier, facility name, or location (city).

**To enter a waypoint identifier:**

- 1) Select the desired WPT page and press the small **right** knob to activate the cursor.
- 2) Turn the small **right** knob to select the first character of the waypoint's identifier.
- 3) Turn the large **right** knob to select the next character field.
- 4) Turn the small **right** knob to select the desired character.
- 5) Repeat steps 3 and 4 until the identifier is selected, then press the **ENT** Key.
- 6) To remove the flashing cursor, press the small **right** knob.

**To enter a waypoint facility name or city location:**

- 1) Select the Airport Location Page, NDB Page or VOR Page from the WPT Page Group (as described on the preceding page).
- 2) Press the small **right** knob to activate the cursor.
- 3) Turn the large **right** knob to select the facility name or location (city) field.
- 4) Turn the small **right** knob to select the desired character (Figure 7-2).

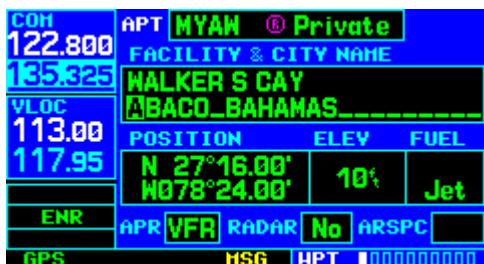

Figure 7-2 Airport Location Page

- 5) Turn the large **right** knob to select the next character field.
- 6) Repeat steps 4 and 5 until the facility name or location is selected, then press the **ENT** Key (Figures 7-3 and 7-4).

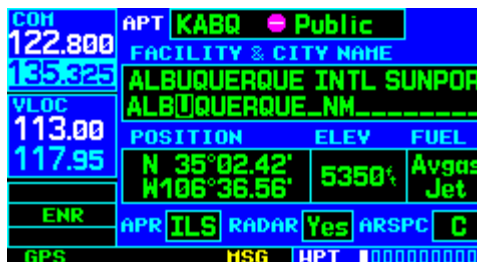

Figure 7-3 Airport Location Page



Figure 7-4 VOR Page

- 7) To remove the flashing cursor, press the small **right** knob.

## Duplicate Waypoints

Once the identifier, facility name, or location is entered, all six airport pages display information for the selected airport. When entering an identifier, facility name, or location, the GNS 430's Spell'N'Find feature scrolls through the database, displaying those waypoints matching the characters that have been entered to that point. If duplicate entries exist for the entered facility name or location, additional entries may be viewed by continuing to turn the small **right** knob during the selection process. If duplicate entries exist for an entered identifier, a Duplicate Waypoint Window appears when the identifier is selected (by pressing the **ENT** Key).

### To select a facility name or location where duplicate entries exist:

- 1) Select the desired facility name or location, following the preceding steps under 'To enter a waypoint facility name or city location'.
- 2) When spelling the facility name or location, using the small and large **right** knobs, the GNS 430's Spell'N'Find feature selects the first entry (Figure 7-5) in the database based upon the characters entered up to that point.

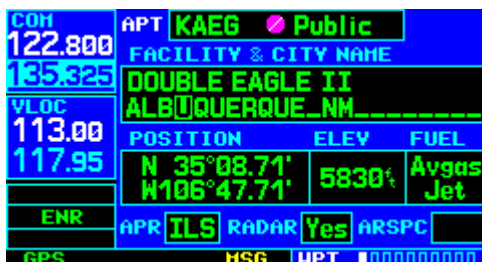

Figure 7-5 First Facility for Albuquerque

- 3) Continue turning the small **right** knob to scroll through any additional database listings (Figure 7-6) for the selected facility name or location. Scroll backwards with the small **right**

knob if the desired facility name or location has been scrolled past.

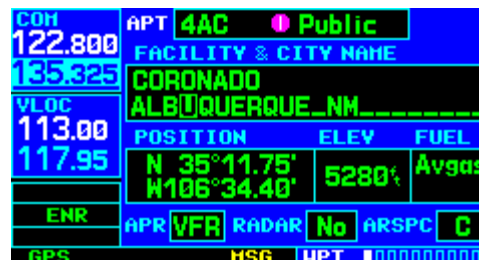

Figure 7-6 Second Facility for Albuquerque

- 4) Press the **ENT** Key to select the desired facility name or location.
- 5) To remove the flashing cursor, press the small **right** knob.

### To select a waypoint identifier from a list of duplicates:

- 1) Select the desired airport or NAVAID identifier following the preceding steps under 'To enter a waypoint facility name or city location'.
- 2) A Duplicate Waypoints Window appears (Figure 7-7). Turn the large **right** knob to select the desired waypoint and press the **ENT** Key.

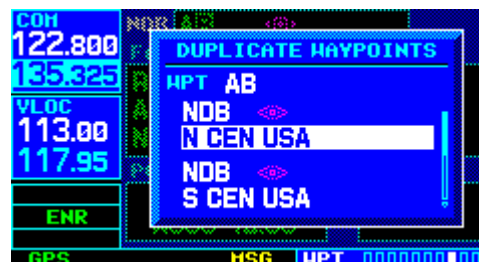
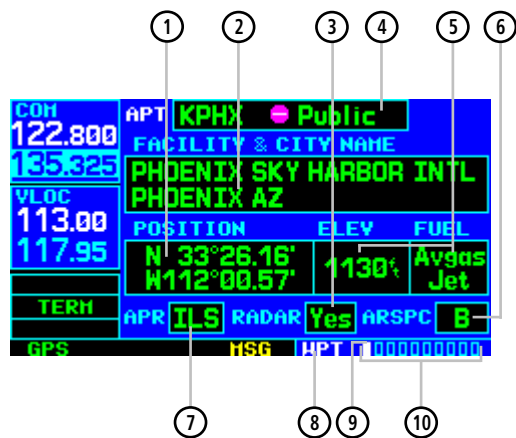

Figure 7-7 Duplicate Waypoints Window

- 3) To remove the flashing cursor, press the small **right** knob.

## 7.2 AIRPORT LOCATION PAGE

The Airport Location Page (Figure 7-8) displays the latitude, longitude, and elevation of the selected airport. The Airport Location Page also displays facility name and location, as well as fuel availability, available approaches, radar coverage, and airspace type.



- ① Position (Latitude/Longitude)
- ② Facility Name and Location (City)
- ③ Radar Coverage
- ④ Airport Identifier, Symbol, and Type
- ⑤ Field Elevation and Available Fuels
- ⑥ Airspace Type
- ⑦ Best Available Approach
- ⑧ Current Page Group
- ⑨ Position of Current Page within Current Page Group
- ⑩ Number of Pages in Current Page Group

**Figure 7-8 Airport Location Page**

The following descriptions and abbreviations are used:

- Type - Usage type: Public, Military, or Private
- Position - Latitude/Longitude (degrees/minutes or degrees/minutes/seconds), MGRS, or UTM/UPS
- Elevation - In feet or meters
- Fuel - For public-use airports, the available fuel type(s) are: Avgas (80-87/100LL/100-130/Mogas), Jet, or None
- Approach - Best available approach: ILS, MLS, LOC, LDA, SDF, GPS, VOR, RNAV ('RNV'), LORAN ('LOR'), NDB, TACAN ('TCN'), Helicopter ('HEL'), or VFR
- Radar - Radar coverage: Yes or No
- Airspace - Control environment: Class B, Class C, Class D, CTA, TMA, TRSA, or none



### 7.3 AIRPORT RUNWAY PAGE

The Airport Runway Page (Figure 7-9) displays runway designations, length, surface type, and lighting for the selected airport. A map image of the runway layout and surrounding area is also displayed on the Airport Runway Page. The map image range appears in the lower left corner and is adjustable using the **RNG** Key. For airports with multiple runways, information for each runway is available.

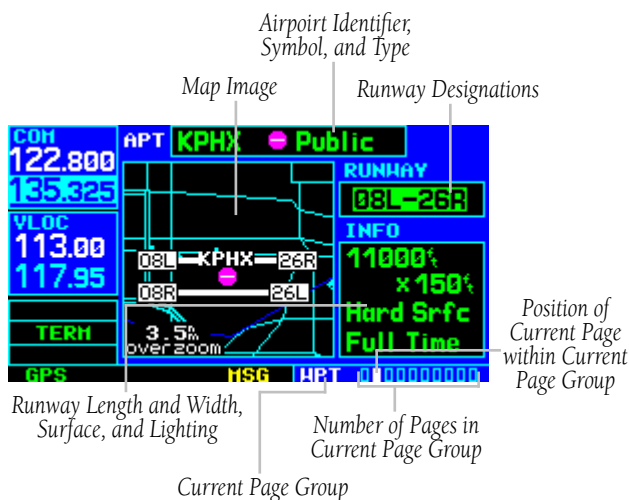

Figure 7-9 Airport Runway Page

To display information for each additional runway:

- 1) Press the small **right** knob to activate the cursor.
- 2) Turn the large **right** knob to place the cursor on the runway designation field (Figure 7-9).
- 3) Turn the small **right** knob to display a window listing all runways for the selected airport (Figure 7-10).



Figure 7-10 Runway Window

- 4) Continue turning the small **right** knob to select the desired runway.
- 5) Press the **ENT** Key to display information for the selected runway on the Airport Runway Page (Figure 7-11).



Figure 7-11 Airport Runway Page

- 6) To remove the flashing cursor, press the small **right** knob.

**To adjust the range of the map image:**

- 1) Press the down arrow of the **RNG** Key to display a smaller map area.
- 2) Press the up arrow of the **RNG** Key to display a larger map area.

The following descriptions and abbreviations are used on the Airport Runway Page:

- Type - Usage type: Public, Military, or Private
- Surface - Runway surface types include: Hard, Turf, Sealed, Gravel, Dirt, Soft, Unknown, or Water
- Lighting - Runway lighting types include: No Lights, Part Time, Full Time, Unknown, or Frequency (for pilot-controlled lighting)

**7.4 AIRPORT FREQUENCY PAGE**

The Airport Frequency Page displays radio frequencies and frequency types for the selected airport, as well as sector and altitude restrictions (where applicable). If the selected airport has a localizer-based approach, the localizer frequency(ies) is also listed on the Airport Frequency Page (Figure 7-12). The Airport Frequency Page may be used to quickly select and tune a COM or VLOC frequency.

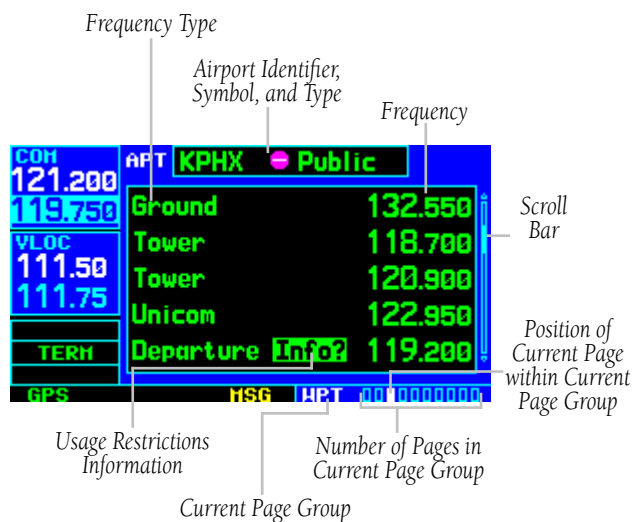

**Figure 7-12 Airport Frequency Page**

**To scroll through the frequency list and tune to a desired frequency on the list:**

- 1) Press the small **right** knob to activate the cursor.

- Turn the large **right** knob to scroll through the list, placing the cursor on the desired frequency (Figure 7-13). If there are more frequencies in the list than can be displayed on the screen, a scroll bar (Figure 7-12) along the right-hand side of the screen indicates the cursor's position within the list.



Figure 7-13 Frequency Highlighted

- Press the **ENT** Key to place the selected frequency in the standby field of the COM or VLOC Window (Figure 7-14).



Figure 7-14 Frequency Moved to Standby Field

- To remove the flashing cursor, press the small **right** knob.

Some listed frequencies may include designations for limited usage, as follows:

- 'TX' - Transmit only
- 'RX' - Receive only
- 'PT' - Part time frequency

If a listed frequency has sector or altitude restrictions, the frequency is preceded by an 'Info?' designation.

**To view usage restrictions for a frequency:**

- Turn the large **right** knob to place the cursor on the 'Info?' designation directly to the left of the desired frequency (Figure 7-15).

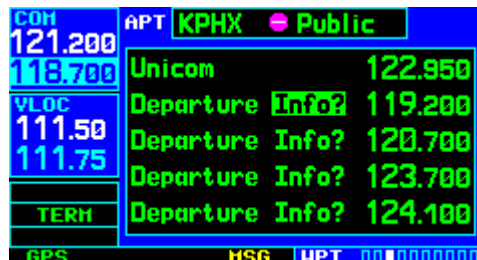

Figure 7-15 'Info?' Highlighted

- Press the **ENT** Key to display the restriction information (Figure 7-16).



Figure 7-16 Restriction Information Page

- To return to the Airport Frequency Page, press the **ENT** Key.

The following descriptions and abbreviations are used on the Airport Frequency Page:

- Type - Usage type: Public, Military, or Private
- Frequency - Communication frequencies which may include restrictions:

|          |          |           |
|----------|----------|-----------|
| Approach | Arrival  | Class B   |
| Class C  | CTA      | Departure |
| TMA      | Terminal | TRSA      |

Communication frequencies without restrictions:

|          |           |            |
|----------|-----------|------------|
| ATIS     | ASOS      | AWOS       |
| Center   | Clearance | Gate       |
| Control  | Ground    | Helicopter |
| Multicom | Pre-taxi  | Radar      |
| Ramp     | Other     | Tower      |

Unicom

Navigation frequencies:

|     |     |
|-----|-----|
| ILS | LOC |
|-----|-----|

## 7.5 AIRPORT APPROACH PAGE

The Airport Approach Page (Figure 7-17) shows the available approach procedures for the selected airport. Where multiple initial approach fixes (IAFs) and feeder routes are available, that information may also be displayed. A map image provides a layout diagram for each approach and transition.

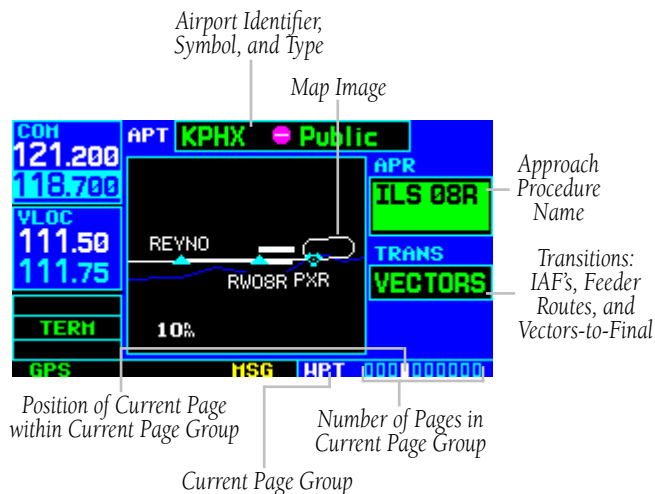

**Figure 7-17 Airport Approach Page**

### To scroll through the available approaches and transitions:

- 1) Press the small **right** knob to activate the cursor.
- 2) Turn the large **right** knob to place the cursor on the approach (APR) procedure name field (Figure 7-17).

- 3) Turn the small **right** knob to display a window of available approaches for the selected airport (Figure 7-18). Continue turning the small **right** knob to select the desired approach.



Figure 7-18 Approach Window

- 4) Press the **ENT** Key. The cursor moves to the transitions (TRANS) field.
- 5) Turn the small **right** knob to display a window of available transitions (Figure 7-19). Continue turning the small **right** knob to select the desired transition or select 'VECTORS' for guidance only along the final course segment of the approach.



Figure 7-19 Transitions Window

- 6) Press the **ENT** Key. To remove the flashing cursor, press the small **right** knob.



*NOTE: Not all approaches in the database are approved for GPS use. When selecting an approach, a 'GPS' designation to the right of the procedure name indicates the procedure can be flown using the GPS receiver. Some procedures do not have this designation, meaning the GPS receiver may be used for supplemental navigation guidance only. ILS approaches, for example, must be flown by tuning the VLOC receiver to the proper frequency and coupling the VLOC receiver to the external CDI (or HSI).*

### Airport Approach Page Options

The following options are available for the Airport Approach Page, by pressing the **MENU** Key:

'Load into Active FPL?' allows the pilot to load the selected approach into the active flight plan without activating it. This performs the same operation as selecting 'Load?' from the Procedures Page 'Select Approach?' option. See Section 6.1.

#### To load an approach from the Airport Approach Page:

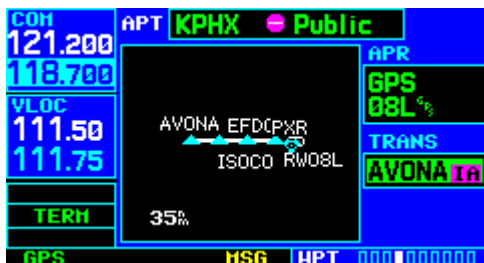

**Figure 7-20 Airport Approach Page**

- 1) Select the desired approach and transition using the steps outlined in Section 6.1 (Figure 7-20).
- 2) Press the **MENU** Key to display the Airport Approach Page Menu.

- 3) Turn the large **right** knob to highlight 'Load into Active FPL?' and press the **ENT** Key (Figure 7-21).



**Figure 7-21 Airport Approach Page Menu**

- 4) The Active Flight Plan Page appears. Press the **FPL** Key to return to the Airport Procedures Page.

Load and Activate? allows the pilot to load the selected approach into the active flight plan and activate navigation guidance to the approach transition (Section 6.1).

To load and activate an approach from the Airport Approach Page, follow the steps above, but select 'Load and Activate?' in step 3.

## 7.6 AIRPORT ARRIVAL PAGE

The Airport Arrival Page (Figure 7-22) shows the available Airport Standard Terminal Arrival (STAR) procedures for the selected airport. Where multiple transitions or runways are associated with the arrival procedure, that information may also be displayed. A map image provides a layout diagram for each arrival, transition, and runway.

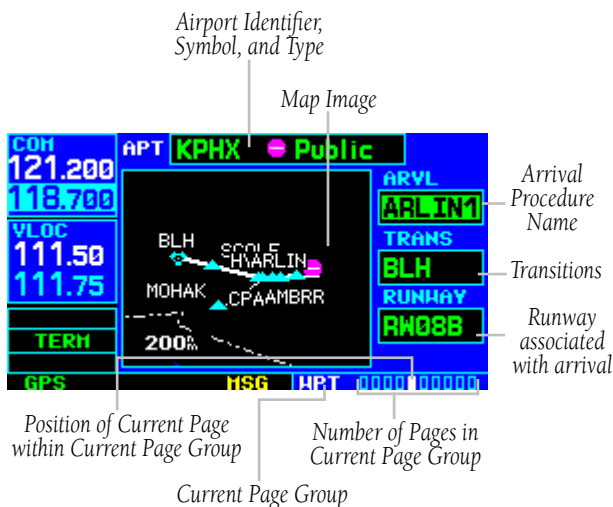

Figure 7-22 Airport Arrival Page

### To scroll through the available arrivals:

- 1) Press the small **right** knob to activate the cursor.
- 2) Turn the large **right** knob to place the cursor on the arrival (ARVL) procedure name field (Figure 7-22).

- 3) Turn the small **right** knob to display a window of available arrivals for the selected airport (Figure 7-23). Continue turning the small **right** knob to select the desired arrival.



Figure 7-23 Arrivals Window

- 4) Press the **ENT** Key. The cursor moves to the transitions (TRANS) field.
- 5) Turn the small **right** knob to display a window of available transitions (Figure 7-24). Continue turning the small **right** knob to select the desired transition.



Figure 7-24 Transitions Window

- 6) Press the **ENT** Key. The cursor moves to the runway field.

- 7) Turn the small **right** knob to display a window of available runways (Figure 7-25). Continue turning the small **right** knob to select the desired runway. ('ALL' may appear in the runway field, indicating the arrival procedure applies to all runways. For airports with parallel runways, 'B' may appear at the end of the runway designation to indicate the arrival procedure applies to both runways.)



Figure 7-25 Runway Window

- 8) Press the **ENT** Key. To remove the flashing cursor, press the small **right** knob.

## Airport Arrival Page Options

The following option is available for the Airport Arrival Page, by pressing the **MENU** Key:

'Load into Active FPL?' allows the pilot to load the selected arrival into the active flight plan. This is identical to loading an arrival procedure from the Procedures Page, as described in Section 6.1.

### To load an arrival procedure from the Airport Arrival Page:

- 1) Select the desired arrival, transition, and runway using the steps above.
- 2) Press the **MENU** Key to display the Airport Arrival Page Menu.
- 3) Press the **ENT** Key to select the 'Load into Active FPL?' option (Figure 7-26).



Figure 7-26 Airport Arrival Page Menu

- 4) The Active Flight Plan Page appears. Press the **FPL** Key to return to the Airport Arrival Page.



## 7.7 AIRPORT DEPARTURE PAGE

The Airport Departure Page (Figure 7-27) shows the available Airport Standard Instrument Departure (SID) procedures for the selected airport. Where multiple runways or transitions are associated with the departure procedure, that information may also be displayed. A map image provides a layout diagram for each departure, runway, and transition.

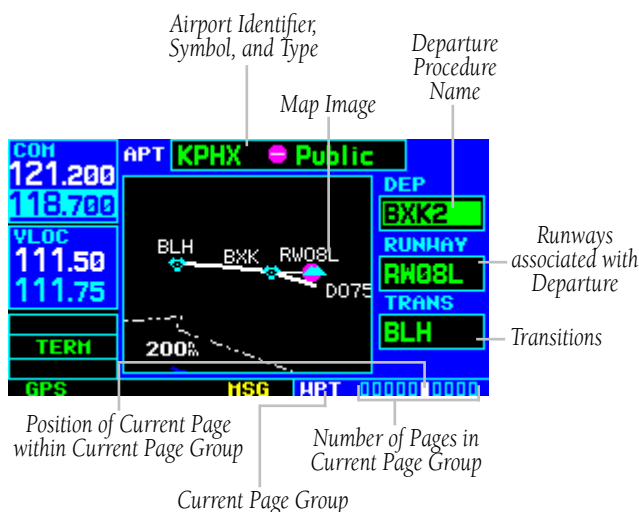

Figure 7-27 Airport Departure Page

### To scroll through the available departures:

- 1) Press the small **right** knob to activate the cursor.
- 2) Turn the large **right** knob to place the cursor on the departure (DEP) procedure name field (Figure 7-27).
- 3) Turn the small **right** knob to display a window of available departures for the selected airport (Figure 7-28). Continue turning the small **right** knob to select the desired departure.



Figure 7-28 Departure Window

- 4) Press the **ENT** Key. The cursor moves to the runway field.
- 5) Turn the small **right** knob to display a window of available runways (Figure 7-29). Continue turning the small **right** knob to select the desired runway. ('ALL' may appear in the runway field, indicating the departure procedure applies to all runways. For airports with parallel runways, 'B' may appear at the end of the runway designation to indicate the departure procedure applies to both runways.)



Figure 7-29 Runway Window

- 6) Press the **ENT** Key. The cursor moves to the transitions (TRANS) field.
- 7) Turn the small **right** knob to display a window of available transitions. Continue turning the small **right** knob to select the desired transition.
- 8) Press the **ENT** Key. To remove the flashing cursor, press the small **right** knob.

## Airport Departure Page Options

The following option is available for the Airport Departure Page, by pressing the **MENU** Key:

'Load into Active FPL?' allows the pilot to load the selected departure into the active flight plan. This is identical to loading a departure procedure from the Procedures Page, as described in Section 6.1.

### To load a departure procedure from the Airport Departure Page:

- 1) Select the desired departure, runway, and transition using the steps above.
- 2) Press the **MENU** Key to display the Airport Departure Page Menu.
- 3) Press the **ENT** Key to select the 'Load into Active FPL?' option (Figure 7-30).

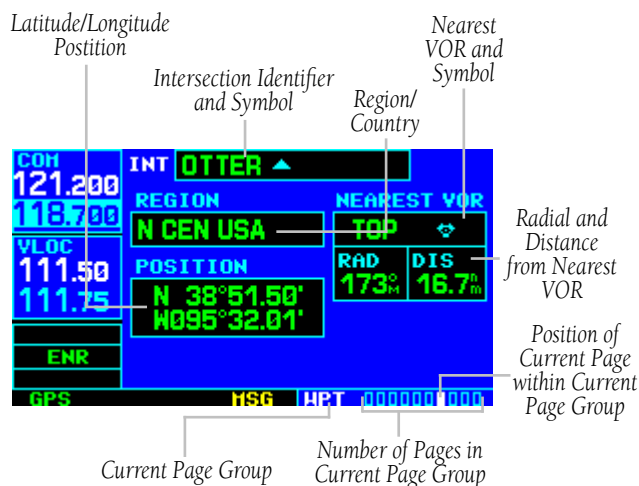

**Figure 7-30 Airport Departure Page Menu**

- 4) The Active Flight Plan Page appears. Press the **FPL** Key to return to the Airport Departure Page.

## 7.8 INTERSECTION PAGE

The Intersection Page (Figure 7-31) displays the latitude, longitude, region, and country for the selected intersection. The Intersection Page also displays the identifier, radial, and distance from the nearest VOR, VORTAC, or VOR/DME.



**Figure 7-31 Intersection Page**

The following descriptions and abbreviations are used:

- Position - Latitude/Longitude (degrees/minutes or degrees/minutes/seconds), MGRS, or UTM/UPS
- RAD - Radial from nearest VOR in degrees magnetic or degrees true (depending upon unit configuration)
- DIS - Distance from nearest VOR, in nautical miles/statute miles/kilometers (depending upon unit configuration)



**NOTE:** The VOR displayed on the Intersection Page is the nearest VOR, not necessarily the VOR used to define the intersection.

Intersections may only be selected by identifier, as described in Section 7.1.

## 7.9 NDB PAGE

The NDB Page displays the facility name, city, region/country, latitude, and longitude for the selected NDB (Figure 7-32). The NDB Page also displays the frequency and a weather broadcast indication (if applicable). As mentioned in Section 7.1, NDBs may be selected by identifier, facility name, or location (city).

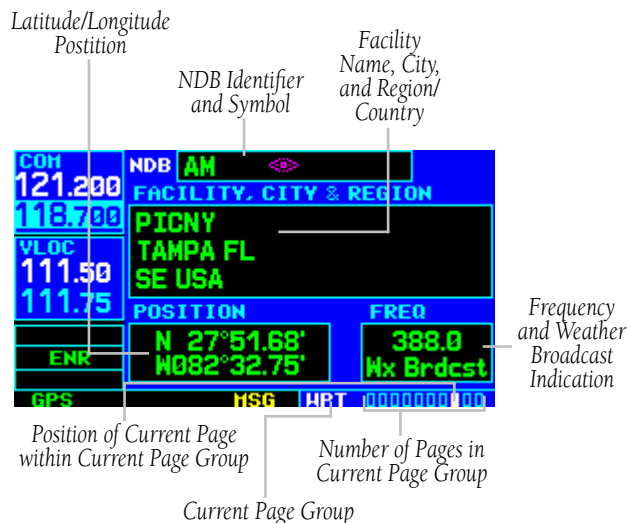

**Figure 7-32 NDB Page**

The following descriptions and abbreviations are used:

- Symbol - See Section 3.4 for a graphic illustration of available NDB symbols
- Position - Latitude/Longitude (degrees/minutes or degrees/minutes/seconds), MGRS, or UTM/UPS
- FREQ - Frequency in kilohertz (kHz)
- Wx Brdcast - Weather information is broadcast on the selected facility's frequency

## 7.10 VOR PAGE

The VOR Page (Figure 7-33) displays the facility name, city, region/country, magnetic variation, latitude, and longitude for the selected VOR. The VOR Page also displays the frequency and a weather broadcast indication (if applicable).

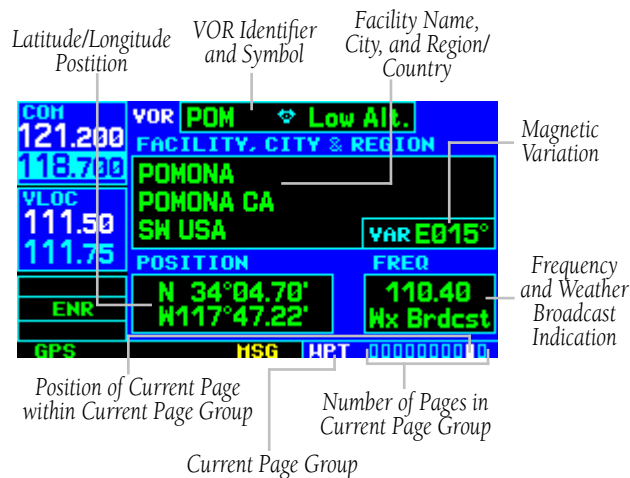

**Figure 7-33 VOR Page**

The following descriptions and abbreviations are used:

- Symbol - See Section 3.4 for a graphic illustration of available VOR symbols
- VAR - Magnetic variation in degrees
- Position - Latitude/Longitude (degrees/minutes or degrees/minutes/seconds), MGRS, or UTM/UPS
- FREQ - Frequency in megahertz (MHz)
- Wx Brdcast - Weather information is broadcast on the selected facility's frequency

As mentioned in Section 7.1, VORs may be selected by identifier, facility name, or location (city). The VOR Page may also be used to quickly tune the VLOC receiver to the selected VOR's frequency.

**To select a VOR frequency from the VOR Page:**

- 1) Select the VOR Page from the WPT Page Group, as described in Section 7.1.
- 2) Press the small **right** knob momentarily to place the cursor on the VOR identifier field (Figure 7-34). To select another VOR, use the small and large **right** knobs and press the **ENT** Key when finished.



Figure 7-34 VOR Identifier Field Selected

- 3) Turn the large **right** knob to highlight the frequency field (Figure 7-35) and press the **ENT** Key to place the frequency in the standby field of the VLOC Window.



Figure 7-35 Frequency Field Highlighted

- 4) To activate the standby VLOC frequency, press the **VLOC Flip-flop** Key (Figure 7-36).



Figure 7-36 Activate the Standby Frequency

## 7.11 USER WAYPOINT PAGE

In addition to the airport, VOR, NDB, and intersection information contained in the Jeppesen NavData card, the GNS 430 allows the pilot to store up to 1,000 user-defined waypoints. The User Waypoint Page (Figure 7-37) displays the waypoint name (up to five characters long), identifier, radial from two reference waypoints, and distance from one reference waypoint, along with the user waypoint's latitude/longitude position.

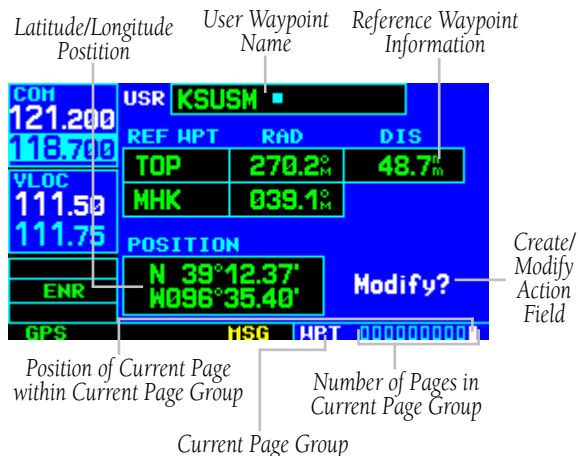

Figure 7-37 User Waypoint Page

The following descriptions and abbreviations appear on the User Waypoint Page:

- REF WPT - Reference waypoint identifier (name)
- RAD - Radial from reference waypoint, in degrees magnetic or degrees true (depending upon unit configuration)
- DIS - Distance from reference waypoint, in nautical miles/statute miles/kilometers (depending upon unit configuration)
- Position - Latitude/Longitude (degrees/minutes or degrees/minutes/seconds), MGRS, or UTM/UPS

User waypoints may only be selected by name (identifier), as described in Section 7.1.

## Creating User Waypoints

User waypoints may be created from the User Waypoint Page or the Map Page. To create a new user waypoint, simply enter its name (identifier) and position, or reference another waypoint by radial and distance.

### To create a new user waypoint by entering its latitude/longitude position:

- 1) With the User Waypoint Page displayed, press the small **right** knob to activate the cursor.
- 2) Use the small and large **right** knobs to enter a name for the new waypoint (Figure 7-38) and press the **ENT** Key. The present position appears in the position field at the bottom of the page (Figure 7-39). To create a waypoint at the present position, turn the large **right** knob to highlight 'Create?' and skip to step 6.

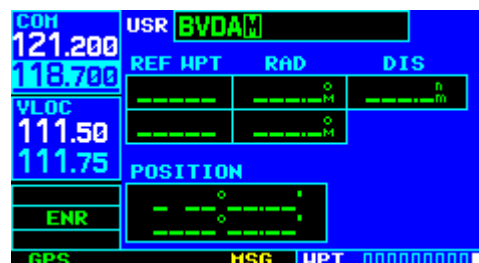

Figure 7-38 User Waypoint Name Field Selected

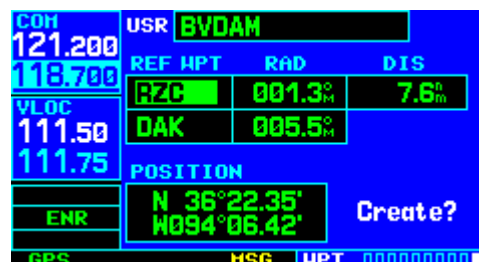

Figure 7-39 Waypoint Name Field Highlighted

- 3) Turn the large **right** knob to highlight the position field at the bottom of the page.
- 4) Use the small and large **right** knobs to enter the position coordinates for the new waypoint (Figure 7-40).

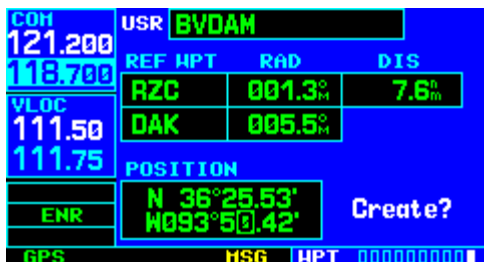

Figure 7-40 Present Position Field Selected

- 5) Press the **ENT** Key to accept the selected position.
- 6) The cursor moves to 'Create?'. Press the **ENT** Key to add the new waypoint to memory.
- 7) Press the small **right** knob to remove the flashing cursor.

**To create a new user waypoint by referencing an existing waypoint:**

- 1) With the User Waypoint Page displayed, press the small **right** knob to activate the cursor.
- 2) Use the small and large **right** knobs to enter a name for the new waypoint and press the **ENT** Key.
- 3) Turn the large **right** knob to highlight the first reference waypoint (REF WPT) field.
- 4) Use the small and large **right** knobs to enter the identifier of the reference waypoint. The reference waypoint can be an airport, VOR, NDB, intersection, or another user waypoint. Press the **ENT** Key to accept the selected identifier.
- 5) The cursor moves to the radial (RAD) field (Figure 7-41). Use the small and large **right** knobs to enter the radial from the reference waypoint to the new user waypoint. Press the **ENT** Key to accept the selected radial.



Figure 7-41 Radial Field Highlighted

- 6) The cursor moves to the distance (DIS) field. Use the small and large **right** knobs to enter the distance from the reference waypoint to the new user waypoint. Press the **ENT** Key to accept the selected distance.

- 7) Turn the large **right** knob to highlight 'Create?' (Figure 7-42) and press the **ENT** Key.

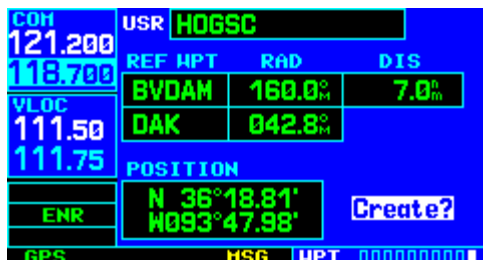

Figure 7-42 'Create?' Highlighted

- 8) Press the small **right** knob to remove the flashing cursor.



*NOTE: The GNS 430 allows the pilot to create a new user waypoint at a defined radial and distance from the present position. To reference the present position, follow the preceding steps, but press the **CLR** Key in Step 4. 'P.POS' appears in the reference waypoint (REF WPT) field to indicate that radial and distance information references the present position. The second reference waypoint field (REF WPT) is a temporary reference only, not a reference that is stored with the user waypoint. By default, this field displays a radial from the nearest VOR. However, the pilot can select any waypoint by identifier to use as a reference in this field. The GNS 430 can store user-defined waypoints which are generated from other equipment in the panel. For example, an EFIS equipped with joystick inputs can be used to create user waypoints which (if the installation supports this) automatically transfer to the GNS 430.*

## Creating User Waypoints from the Map Page

The Map Page and panning target pointer (Section 3.4, Map Panning) provide a quick means of saving the present position as a user-defined waypoint.

### To capture and save the present position as a user waypoint:

- 1) With the Map Page displayed, press the small **right** knob to activate the panning function. The target pointer appears at the present position (Figure 7-43).



Figure 7-43 Activate Panning Function

- 2) Press the **ENT** Key to capture the position and display the User Waypoint Page (Figure 7-44).

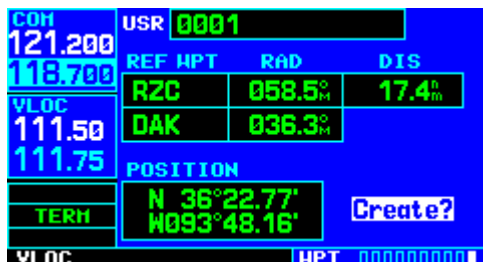

Figure 7-44 User Waypoint Page

- 3) A four-digit name is automatically assigned to the waypoint. To change this name, turn the large **right** knob to highlight the name field, then use the small and large **right** knobs to select a new name. Press the **ENT** Key to accept the selected name.
- 4) The cursor moves to the 'Create?' action field. Press the **ENT** Key to save the new waypoint.

## Modifying User Waypoints

To modify an existing waypoint, select that waypoint on the User Waypoint Page and enter the new position information directly over the old information.

### To modify a user waypoint by changing its latitude/longitude position:

- 1) With the User Waypoint Page displayed, press the small **right** knob to activate the cursor.
- 2) Use the small and large **right** knobs to enter the name of the desired waypoint and press the **ENT** Key.
- 3) Turn the large **right** knob to highlight the position field at the bottom of the page.
- 4) Use the small and large **right** knobs to enter the new position coordinates (Figure 7-45) and press the **ENT** Key to accept the selected position.

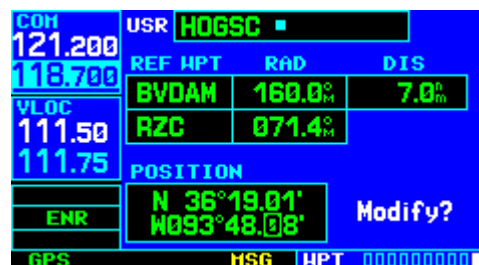

Figure 7-45 Position Field Selected

- 5) The cursor moves to the 'Modify?' action field. Press the **ENT** Key to modify the waypoint.
- 6) Press the small **right** knob to remove the flashing cursor.



### To modify a user waypoint by changing reference waypoint information:

- 1) With the User Waypoint Page displayed, press the small **right** knob to activate the cursor.
- 2) Use the small and large **right** knobs to enter the name of the desired waypoint and press the **ENT** Key.
- 3) Turn the large **right** knob to highlight the first reference waypoint (REF WPT) field, to change the reference waypoint. Otherwise, continue turning the large **right** knob to highlight the radial (RAD) or distance (DIS) field, as desired.
- 4) Use the small and large **right** knobs to change the identifier (if desired) of the reference waypoint (Figure 7-46). The reference waypoint can be an airport, VOR, NDB, intersection or another user waypoint. Press the **ENT** Key to accept the selected identifier.

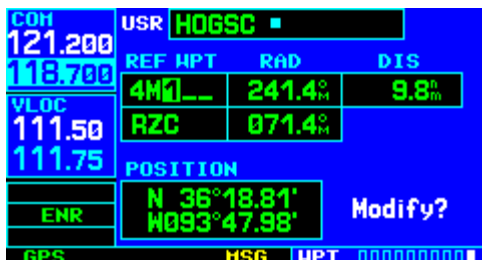

Figure 7-46 Ref Waypoint Field Selected

- 5) The cursor moves to the radial (RAD) field (Figure 7-47). Use the small and large **right** knobs to change the radial from the reference waypoint, if desired. Press the **ENT** Key to accept the selected radial.

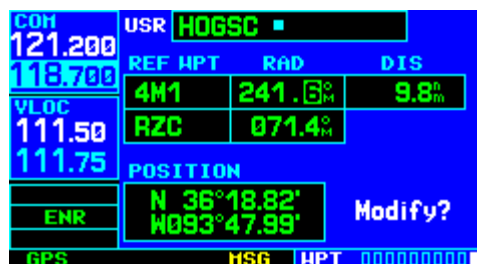

Figure 7-47 Radial Field Selected

- 6) The cursor moves to the distance (DIS) field (Figure 7-48). Use the small and large **right** knobs to change the distance from the reference waypoint to the new user waypoint, if desired. Press the **ENT** Key to accept the selected distance.

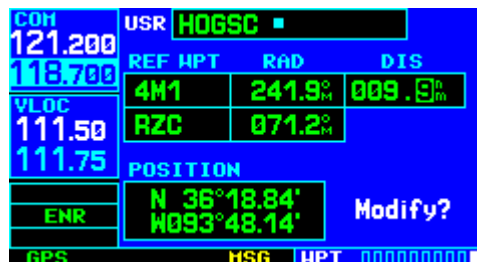

Figure 7-48 Distance Field Selected

- 7) The cursor moves to the 'Modify?' action field. Press the **ENT** Key to modify the waypoint.
- 8) Press the small **right** knob to remove the flashing cursor.



**NOTE:** If the pilot attempts to modify or delete a waypoint which is currently a direct-to waypoint or the current 'from' or 'to' waypoint in the active flight plan, the GNS 430 alerts the pilot with the 'Can't change an active waypoint' or 'Waypoint is active and can't be deleted' message. The pilot must first cancel the direct-to or remove the waypoint(s) from the active flight plan before modifying or deleting the waypoint(s).

## User Waypoint Page Options

The following User Waypoint Page options are available by pressing the **MENU** Key:

‘View User Waypoint List?’ displays a list of all user waypoints currently stored in memory.

### To view a list of all user waypoints:

- 1) From the User Waypoint Page, press the **MENU** Key to display the User Waypoint Page Menu.
- 2) Turn the large **right** knob to highlight ‘View User Waypoint List?’ (Figure 7-49) and press the **ENT** Key.

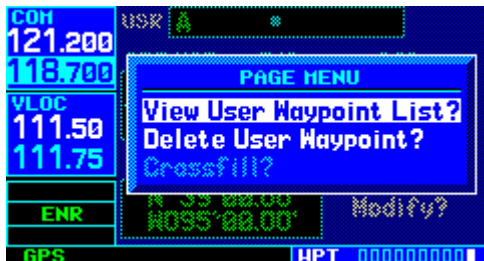

Figure 7-49 User Waypoint Page Menu

- 3) The top of the User Waypoint List indicates the total number of user waypoints currently used and available memory (Figure 7-50). If more user waypoints are stored than can be displayed on a single screen, turn the large **right** knob to scroll through the User Waypoint List.



Figure 7-50 User Waypoint List Page

- 4) Press the small **right** knob to return to the User Waypoint Page.

‘Delete User Waypoint?’ allows the pilot to delete the selected waypoint from memory.

### To delete a user waypoint:

- 1) Select the desired waypoint on the User Waypoint Page and press the **MENU** Key to display the User Waypoint Page Menu.
- 2) Turn the large **right** knob to highlight ‘Delete User Waypoint?’ (Figure 7-51) and press the **ENT** Key.

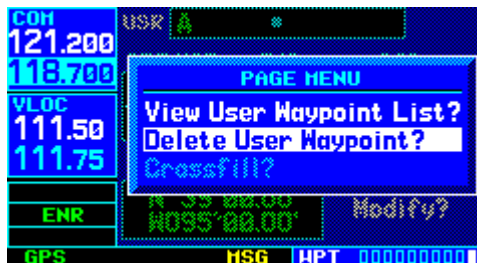

Figure 7-51 User Waypoint Page Menu

‘Crossfill?’ allows the pilot to transfer a user waypoint to another 400/500 series unit (if installed). Please refer to Sections 5.1 and 10.1 for detailed information on crossfill.

## User Waypoint List

The User Waypoint List (Figure 7-52) allows the pilot to review, modify, rename, or delete a selected user waypoint, or to delete all user waypoints currently stored in memory. The top of the page shows the number of waypoints used and available memory.

### To review and/or modify a user waypoint from the User Waypoint List:

- 1) Select the User Waypoint List, as described in this section.
- 2) Turn the large **right** knob to highlight the desired user waypoint (Figure 7-52).

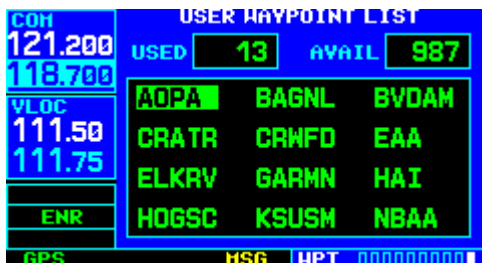

Figure 7-52 User Waypoint List Page

- 3) Press the **ENT** Key to display the User Waypoint Page for the selected waypoint. From this page the pilot may review all information defining the waypoint and its position.
- 4) To modify the waypoint's position or reference waypoint information, follow the steps described in this section.
- 5) To exit the User Waypoint Page, turn the large **right** knob to highlight 'Done?' and press the **ENT** Key.

### To rename a user waypoint from the User Waypoint List:

- 1) Select the User Waypoint List, as described in this section.
- 2) Turn the large **right** knob to highlight the desired user waypoint.
- 3) Use the small and large **right** knobs to change the name of the user waypoint (Figure 7-53). (Enter the new name directly over the old name.) Press the **ENT** Key to accept the new name.



Figure 7-53 User Waypoint Name Selected

- 4) A 'rename waypoint' confirmation window is displayed (Figure 7-54). With 'Yes?' highlighted, press the **ENT** Key to rename the selected user waypoint.

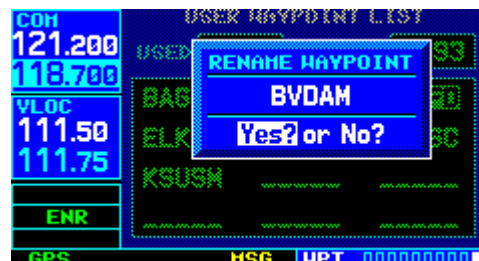

Figure 7-54 Rename Waypoint Window

**To delete a user waypoint from the User Waypoint List:**

- 1) Select the User Waypoint List, as described in this section.
- 2) Turn the large **right** knob to highlight the desired user waypoint.
- 3) Press the **CLR** Key to display a 'delete waypoint' confirmation window (Figure 7-55).

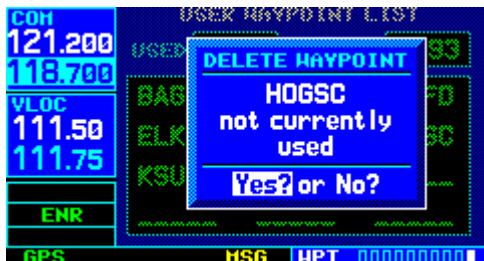

Figure 7-55 Delete Waypoint Window

- 4) With 'Yes?' highlighted, press the **ENT** Key to delete the selected user waypoint.

**To delete all user waypoints from memory:**

- 1) Select the User Waypoint List, as described in this section.
- 2) Press the **MENU** Key to display a menu for the User Waypoint List (Figure 7-56).

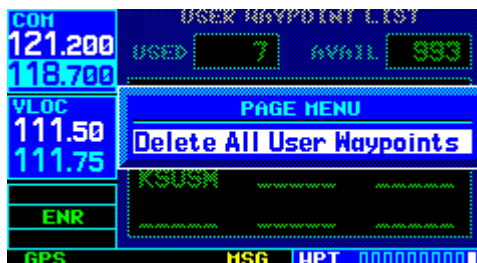

Figure 7-56 User Waypoint List Page Menu

- 3) With 'Delete All User Waypoints' highlighted, press the **ENT** Key.
- 4) A 'delete all waypoints' confirmation window is displayed (Figure 7-57). With 'Yes?' highlighted, press the **ENT** Key to delete all user waypoints from memory.

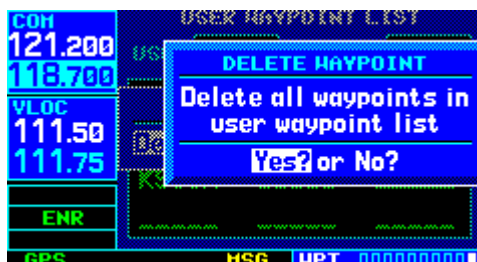

Figure 7-57 Delete All Waypoints Window

## SECTION 8: NRST PAGES

### 8.1 NRST PAGE GROUP

Section 3.1 introduced the GNS 430's main page groups (Table 8-1)—NAV, WPT, AUX, NRST—and described each page in the NAV group. This fourth page group (NRST) provides detailed information for the nine nearest airports, VORs, NDBs, intersections, and user waypoints within 200 nm of the current position. In addition, the NRST pages (Figure 8-1) include the five nearest Flight Service Station (FSS) and center (ARTCC/FIR) points of communication, plus alerts the pilot to any nearby Special Use (SUA) or Controlled Airspaces.

| Page Groups   |               |                |              |
|---------------|---------------|----------------|--------------|
| NAV Group     | WPT Group     | AUX Group      | NRST Group   |
| see Section 3 | see Section 7 | see Section 10 | 8 NRST pages |

Table 8-1 Page Groups

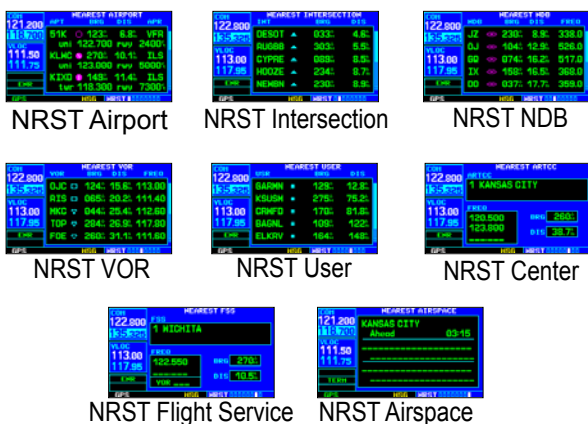

Figure 8-1 NRST Pages

To quickly select a NRST page:

- 1) From any page, press and hold the **CLR** Key to select the Default NAV Page (Figure 8-2). This step may be skipped if any of the main pages are already displayed.



Figure 8-2 Default NAV Page

- 2) Turn the large **right** knob to select the NRST Page Group (Figure 8-3). 'NRST' appears in the lower **right** corner of the screen.



Figure 8-3 Nearest Airport Page

- 3) Turn the small **right** knob to select the desired NRST page.

Not all nine nearest airports, VORs, NDBs, intersections, or user waypoints can be displayed on the corresponding NRST page at one time. The Nearest Airport Page displays detailed information for three nearest airports, with a scroll bar along the right-hand side of the page indicating which part of the list is currently being viewed. The Nearest Airspace Page displays detailed information for up to three special use or controlled airspace alerts. The NRST pages for VORs, NDBs, intersections, and user waypoints displays five waypoints at a time. The flashing cursor and large **right** knob are used to scroll and view the rest of the waypoints or airspaces in the list.

**To scroll through the list of nearest airports, VORs, NDBs, intersections, user waypoints, or SUAs:**

- 1) Select the desired NRST page, using the steps outlined on the preceding page.
- 2) Press the small **right** knob to activate the cursor.
- 3) Turn the large **right** knob to scroll through the list. The scroll bar along the right-hand side of the page indicates which part of the list is currently being viewed (Figure 8-4).



Figure 8-4 Nearest Airport Page

- 4) Press the small **right** knob to remove the flashing cursor.

The Nearest ARTCC Page and the Nearest FSS Page present detailed information for up to five nearby facilities, displaying only one facility at a time. Again, the additional information is viewed using the flashing cursor and large **right** knob to scroll through the list.

**To scroll through the list of nearest flight service station or center points of communication:**

- 1) Select the desired NRST page, using the steps outlined on the preceding page.
- 2) Press the small **right** knob to activate the cursor.
- 3) Turn the small **right** knob to scroll through the list (Figure 8-5).



Figure 8-5 Nearest FSS Page

- 4) Press the small **right** knob to remove the flashing cursor.

## Navigating to a Nearby Waypoint

The NRST pages can be used in conjunction with the GNS 430's direct-to function to quickly set a course to a nearby facility. This feature can be a real time saver compared to retrieving information from the database using the WPT pages. More importantly, it instantly provides navigation to the nearest airport in case of an in-flight emergency.

**To select a nearby airport, VOR, NDB, intersection, or user waypoint as a direct-to destination:**

- 1) Use the flashing cursor to scroll through a NRST page list (Figure 8-6) and highlight the desired nearest waypoint, as outlined in Section 8.1.



Figure 8-6 Nearest VOR Page

- 2) Press the **Direct-to** Key to display the select Direct-to Waypoint Page (Figure 8-7).



Figure 8-7 Direct-to Waypoint Page

- 3) Press the **ENT** Key to accept the selected waypoint's identifier and press the **ENT** Key a second time (Figure 8-8) with 'Activate?' highlighted to begin navigating to the selected waypoint.



Figure 8-8 'Activate?' Highlighted

## 8.2 NEAREST AIRPORT PAGE

The Nearest Airport Page displays the identifier, symbol, bearing, and distance to the nine nearest airports (within 200 nm of the present position). For each airport listed, the Nearest Airport Page also indicates the best available approach, common traffic advisory frequency (CTAF), and the length of the longest runway (Figure 8-9).

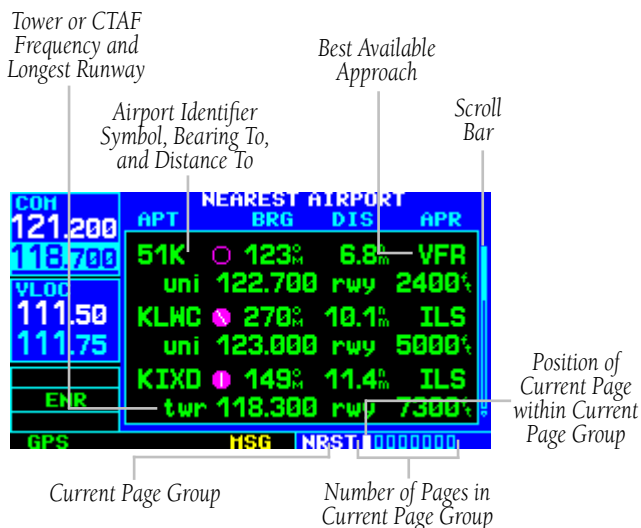

**Figure 8-9 Nearest Airport Page**

The Nearest Airport Page can be configured to exclude shorter runways or undesirable runway surface types, so that the corresponding airports do not appear on the list. The pilot may wish to use this feature to exclude seaplane bases or runway lengths which would be difficult or impossible to land upon. See Section 10.5, Setup Page 2: Nearest Airport Criteria for additional details.

The Nearest Airport Page may be used to quickly tune the COM transceiver to a nearby airport. The selected frequency is placed in the standby field of the COM Window and activated using the **COM Flip-flop** Key.

### To quickly tune the common traffic advisory frequency (CTAF) from the Nearest Airport Page:

- 1) Select the Nearest Airport Page, using the steps outlined in Section 8.1.
- 2) Press the small **right** knob to activate the cursor.
- 3) Turn the large **right** knob to scroll through the list, highlighting the COM frequency associated with the desired airport (Figure 8-10).



**Figure 8-10 COM Frequency Highlighted**

- 4) Press the **ENT** Key to place the selected frequency in the standby field of the COM Window (Figure 8-11).



**Figure 8-11 Frequency Moved to Standby Field**



- 5) Press the **COM Flip-flop** Key to activate the selected frequency (Figure 8-12).

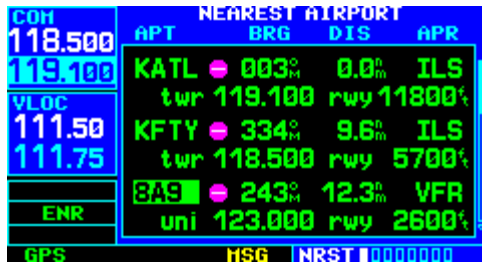

Figure 8-12 Frequency Moved to Active Field

- 6) Press the small **right** knob to remove the flashing cursor.

Additional communication frequencies, runway information, and more is available from the Nearest Airport Page by highlighting the identifier of the desired airport and pressing the **ENT** Key.

**To view additional information for a nearby airport:**

- 1) Select the Nearest Airport Page, using the steps outlined in Section 8.1.
- 2) Press the small **right** knob to activate the cursor.
- 3) Turn the large **right** knob to scroll through the list, highlighting the identifier of the desired airport (Figure 8-13).

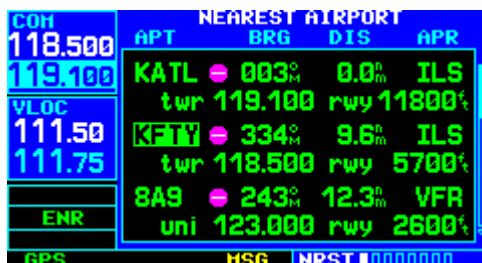

Figure 8-13 Desired Airport Highlighted

- 4) Press the **ENT** Key to display the Airport Location Page for the selected airport (Figure 8-14).



Figure 8-14 Airport Location Page

- 5) To view additional WPT pages for the selected airport (including the Airport Runway Page and the Airport Frequency Page) press the small **right** knob to remove the flashing cursor. Turn the small **right** knob to display the additional WPT pages (Figure 8-15). When finished, press the small **right** knob to return the flashing cursor to the screen.



Figure 8-15 Additional WPT Page

- 6) To return to the Nearest Airport Page, verify that 'Done?' is highlighted by the flashing cursor and press the **ENT** Key (or press the **CLR** Key).

### 8.3 NEAREST INTERSECTION PAGE

The Nearest Intersection Page displays the identifier, symbol, bearing, and distance to the nine nearest intersections (within 200 nm of the present position).

To view additional information for a nearby intersection, start from the Nearest Intersection Page and follow the preceding steps 2 through 4.

### 8.4 NEAREST NDB PAGE

The nearest NDB Page displays the identifier, symbol, bearing, distance, and frequency to the nine nearest NDBs (within 200 nm of the present position).

To view additional information for a nearby NDB, start from the nearest NDB Page and follow the preceding steps 2 through 4.

### 8.5 NEAREST VOR PAGE

The nearest VOR Page (Figure 8-16) displays the identifier, symbol, bearing, and distance to the nine nearest VORs (within 200 nm of the present position). For each VOR listed, the nearest VOR Page also indicates the frequency and may be used to quickly tune the VLOC receiver to the nearby VOR. The selected frequency is placed in the standby field of the VLOC Window and activated using the **VLOC Flip-flop** Key.

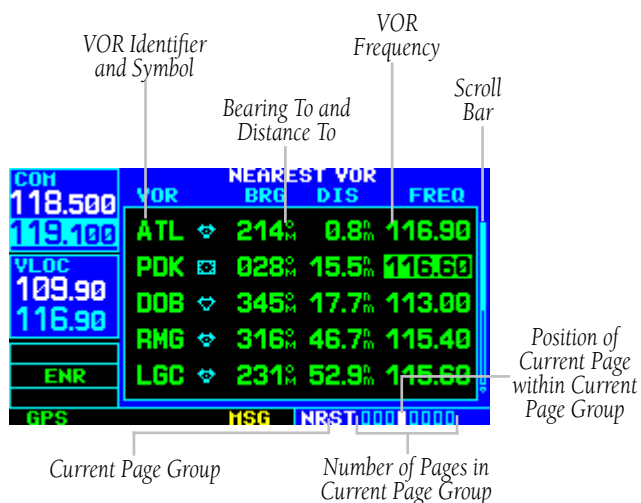

**Figure 8-16 Nearest VOR Page**

**To quickly tune a VOR's frequency from the nearest VOR Page:**

- 1) Select the nearest VOR Page, using the steps outlined in Section 8.1.
- 2) Press the small **right** knob to activate the cursor.
- 3) Turn the large **right** knob to scroll through the list, highlighting the frequency associated with the desired VOR (Figure 8-16).
- 4) Press the **ENT** Key to place the selected frequency in the standby field of the VLOC Window (Figure 8-17).



Figure 8-17 Move Frequency to Standby Field

- 5) Press the **VLOC Flip-flop** Key to activate the selected frequency.
- 6) Press the small **right** knob to remove the flashing cursor.

**To view additional information for a nearby VOR:**

- 1) Select the nearest VOR Page, using the steps outlined in Section 8.1.
- 2) Press the small **right** knob to activate the cursor.
- 3) Turn the large right knob to scroll through the list, highlighting the identifier of the desired VOR (Figure 8-18).



Figure 8-18 Nearest VOR Page

- 4) Press the **ENT** Key to display the VOR Page for the selected VOR.
- 5) To return to the nearest VOR Page, verify that 'Done?' is highlighted by the flashing cursor and press the **ENT** Key (or press the **CLR** Key).
- 6) Press the small **right** knob to remove the flashing cursor.

## 8.6 NEAREST USER WAYPOINT PAGE

The Nearest User Waypoint Page displays the name, bearing and distance to the nine nearest user waypoints (within 200 nm of the present position).

## 8.7 NEAREST CENTER (ARTCC) PAGE

The Nearest Center Page (Figure 8-19) displays the facility name, bearing to, and distance to the five nearest ARTCC points of communication (within 200 nm of the present position). For each ARTCC listed, the Nearest Center Page also indicates the frequency(ies) and may be used to quickly tune the COM transceiver to the center's frequency. The selected frequency is placed in the standby field of the COM Window and activated using the **COM Flip-flop** Key.

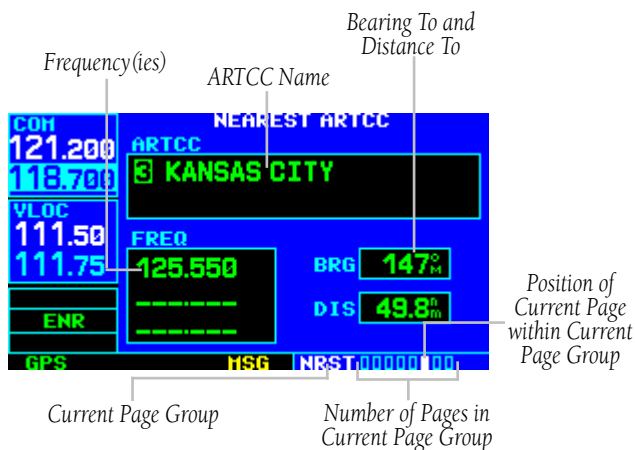

Figure 8-19 Nearest ARTCC Page

**To quickly tune an ARTCC's frequency from the Nearest Center Page:**

- 1) Select the Nearest Center Page, using the steps outlined in Section 8.1.

- 2) Press the small **right** knob to activate the cursor.
- 3) Turn the large **right** knob to scroll through the list, selecting the desired ARTCC (Figure 8-19).
- 4) Turn the large **right** knob to scroll down the page, highlighting the desired frequency (Figure 8-20).



Figure 8-20 Frequency Field Highlighted

- 5) Press the **ENT** Key to place the selected frequency in the standby field of the COM Window (Figure 8-21).



Figure 8-21 Frequency Moved to Standby Field

- 6) Press the **COM Flip-flop** Key to activate the selected frequency.
- 7) Press the small **right** knob to remove the flashing cursor.

## 8.8 NEAREST FLIGHT SERVICE STATION (FSS) PAGE

The Nearest Flight Service Station Page (Figure 8-22) displays the facility name, bearing to, and distance to the five nearest FSS points of communication (within 200 nm of the present position). For each FSS listed, the Nearest Flight Service Station Page also indicates the frequency(ies) and may be used to quickly tune the COM transceiver to the FSS's frequency. The selected frequency is placed in the standby field of the COM Window and activated using the **COM Flip-flop** Key.

For duplex operations, 'RX' and 'TX' indications appears beside the listed frequencies, indicating 'receive only' or 'transmit only' frequencies. The associated VOR is also provided for reference.

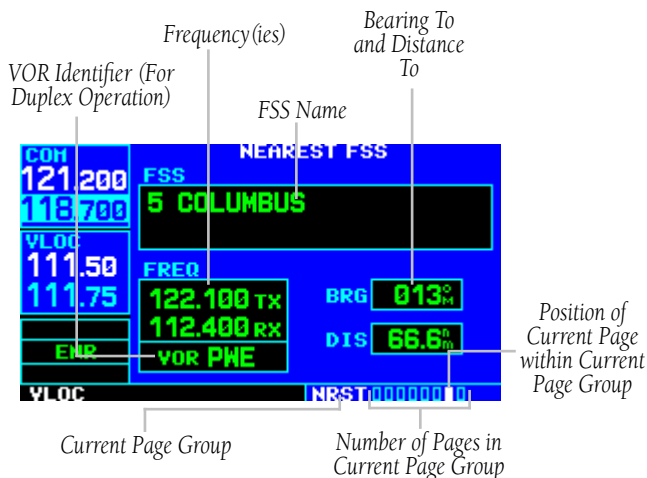

Figure 8-22 Nearest FSS Page

To quickly tune an FSS's frequency from the Nearest Flight Service Station Page:

- 1) Select the Nearest Flight Service Station Page, using the steps outlined in Section 8.1 (Figure 8-22).
- 2) Press the small **right** knob to activate the cursor.
- 3) Turn the small **right** knob to scroll through the list, selecting the desired FSS (Figure 8-23).



Figure 8-23 FSS Field Selected

- 4) Turn the large **right** knob to scroll down the page (Figure 8-24), highlighting the desired frequency (COM frequency[ies] or VOR frequency for duplex operation).



Figure 8-24 Frequency Field Highlighted

- 5) Press the **ENT** Key to place the selected frequency in the standby field of the COM or VLOC Window (figure 8-25).



**Figure 8-25** Frequency Moved to Standby Field

- 6) Press the **COM Flip-flop** or **VLOC Flip-flop** Key, as appropriate, to activate the selected frequency.
- 7) Press the small **right** knob to remove the flashing cursor.

## 8.9 NEAREST AIRSPACE PAGE

The last page in the NRST group, the Nearest Airspace Page alerts the pilot to as many as nine controlled or special use airspaces near or in the flight path. Alerts are provided according to the following conditions:

- If the aircraft's projected course will take it inside an airspace within the next ten minutes, the alert message 'Airspace ahead -- less than 10 minutes' appears (Figure 8-26). The Nearest Airspace Page shows the airspace as 'Ahead'.



**Figure 8-26** Airspace Messages

- If the aircraft is within two nautical miles of an airspace and the current course will take it inside the airspace, the message 'Airspace near and ahead' appears (Figure 8-26). The Nearest Airspace Page shows 'Within 2nm of airspace'.
- If aircraft is within two nautical miles of an airspace and the current course will not take it inside the airspace, the message 'Near airspace less than 2nm' appears. The Nearest Airspace Page shows the airspace as 'Ahead < 2nm'.

- If the aircraft has entered an airspace, the message 'Inside Airspace' appears (Figure 8-27). The Nearest Airspace Page shows 'Inside of airspace'.



Figure 8-27 Airspace Messages

Note that the airspace alerts are based on three-dimensional data (latitude, longitude, and altitude) to avoid nuisance alerts. The alert boundaries for controlled airspace are also sectorized to provide complete information on any nearby airspace. Once one of the described conditions exists, the message annunciator flashes, alerting the pilot of an airspace message.

**To view an airspace alert message:**

- 1) When the message annunciator above the **MSG** Key flashes, press the **MSG** Key.
- 2) Press the **MSG** Key again to return to the previous page.

Once an airspace alert message appears, detailed information concerning the specific airspace is provided on the Nearest Airspace Page (Figure 8-28). The Nearest Airspace Page displays the airspace name, status ('Ahead', 'Ahead < 2nm', etc., as described on the preceding page), and a time to entry (if applicable). By selecting any airspace name listed on the Nearest Airspace Page, additional details are provided—including controlling agency, communication frequencies, and floor/ceiling limits.

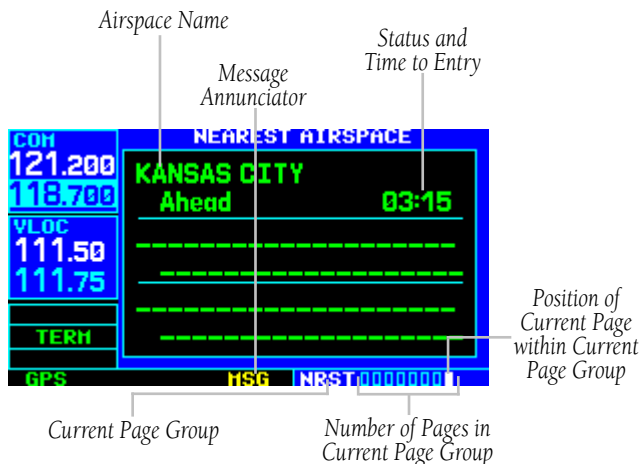

Figure 8-28 Nearest Airspace Page

**To view additional details for an airspace listed on the Nearest Airspace Page:**

- 1) Select the Nearest Airspace Page, using the steps outlined in Section 8.1 (Figure 8-29).



Figure 8-29 Nearest Airspace Page

- 2) Press the small **right** knob to activate the cursor.

- Turn the large **right** knob to scroll through the list, highlighting the desired airspace (Figure 8-30).



Figure 8-30 Airspace Highlighted

- Press the **ENT** Key to display the Airspace Page for the selected nearby airspace (Figure 8-31).

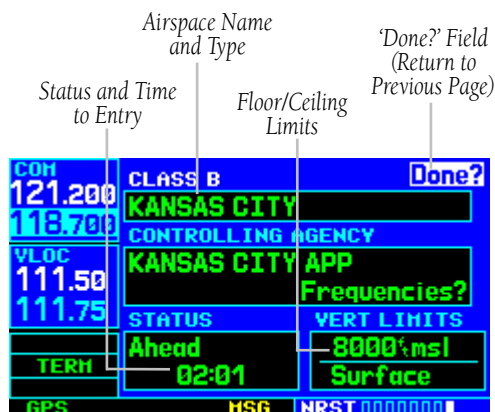

Figure 8-31 Airspace Page

- To return to the Nearest Airspace Page, verify that 'Done?' is highlighted by the flashing cursor and press the **ENT** Key.
- Press the small **right** knob to remove the flashing cursor.

**To view and quickly tune the frequency for a controlling agency:**

- Follow steps 1 through 4 on the preceding page to display the Airspace Page (Figure 8-31) for the desired controlled or special use airspace.
- Turn the large **right** knob to highlight 'Frequencies?' and press the **ENT** Key.
- Turn the large **right** knob to scroll through the list, highlighting the desired frequency (Figure 8-32).

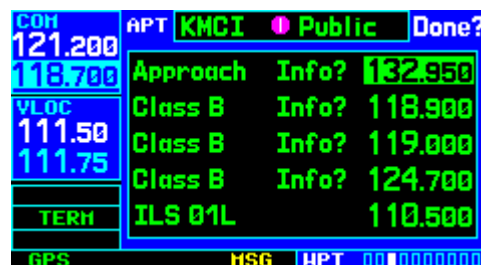

Figure 8-32 Frequency Highlighted

- Press the **ENT** Key to place the selected frequency in the standby field of the COM Window.
- Press the **COM Flip-flop** Key to activate the selected frequency (Figure 8-33).

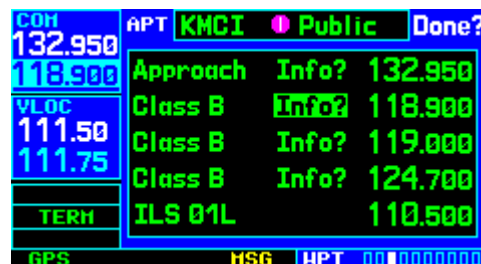

Figure 8-33 Frequency Moved to Active Field



- 6) To return to the Airspace Page, turn the large **right** knob to highlight 'Done?' and press the **ENT** Key (or press the **CLR** Key).
- 7) To return to the Nearest Airspace Page, turn the large **right** knob to highlight 'Done?' and press the **ENT** Key (or press the **CLR** Key).
- 8) Press the small **right** knob to remove the flashing cursor.

The Airspace Page displays (and airspace alert messages are provided for) the following airspace types (Figures 8-34, 8-35, and 8-36):

- Alert
- Class B
- Class D
- Danger
- Prohibited
- TMA
- TRSA
- Warning
- Caution
- Class C
- CTA
- MOA
- Restricted
- Training
- Unspecified

The bottom right-hand corner of the Airspace Page displays the floor and ceiling limits of the airspace.

The following are examples of what may appear as vertical limits for an airspace:

- 5000ft msl (5000 feet mean sea level)
- 5000ft agl (5000 feet above ground level)
- MSL (at mean sea level)
- NOTAM (Notice to Airmen)
- Unknown
- See Chart
- Unlimited
- Surface

All airspace alert messages, except for prohibited areas, may be turned on or off from the Airspace Alarms Page. An altitude buffer is also provided on the Airspace Alarms Page to provide an extra margin of safety above/below the published limits (Section 10.4, Setup 1 Page: Airspace Alarms for additional details).



Figure 8-34 Airspace Page for Class C Airspace



Figure 8-35 Airspace Page for MOA

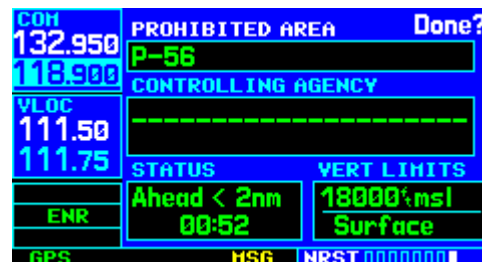

Figure 8-36 Airspace Page for Prohibited Area

Blank Page

## SECTION 9: VLOC RECEIVER

### 9.1 VLOC (VOR/LOCALIZER/GLIDESLOPE) RECEIVER OPERATIONS

The GNS 430 includes digitally-tuned VOR/localizer and glideslope receivers with the desired frequency selected in the VLOC Window, along the left-hand side of the display (Figure 9-1). Frequency selection is performed by pressing the small **left** knob and turning the small and large **left** knobs to select the desired frequency.



Figure 9-1 VLOC Window

#### Ident Audio and Volume

VLOC ident is enabled by pressing the **VLOC Volume** Knob. When VLOC ident is enabled, an 'ID' indication appears in the upper right corner of the VLOC Window, to the immediate right of 'VLOC' (Figure 9-1).

VLOC audio volume is adjusted using the **VLOC Volume** Knob. Turn the **VLOC Volume** Knob clockwise to increase volume, or counterclockwise to decrease volume.

#### VLOC Window and Tuning

VLOC frequencies are tuned with the large and small **left** knobs when the tuning cursor is in the standby VLOC frequency field. The standby frequency always appears below the active frequency. The active frequency is the frequency currently in use.

The tuning cursor remains in the COM Window. To select a VOR/Localizer/ILS frequency, press the small **left** knob momentarily to place the cursor in the VLOC Window.



*NOTE: The tuning cursor normally appears in the COM Window, unless placed in the VLOC Window by pressing the small **left** knob. When the tuning cursor is in the VLOC Window, it automatically returns to the COM Window after 30 seconds of inactivity. The active frequency in either window cannot be accessed directly—only the standby frequency is highlighted by the tuning cursor.*

#### To select a VOR/localizer/ILS frequency:

- 1) If the tuning cursor is not currently in the VLOC Window, press the small **left** knob momentarily (Figure 9-2).

Tuning Cursor in VLOC Window



Figure 9-2 Tuning Cursor in VLOC Window

- Turn the large **left** knob to select the desired megahertz (MHz) value. For example, the '117' portion of the frequency '117.60' (Figure 9-3).



Figure 9-3 Select VOR Megahertz Frequency

- Turn the small **left** knob to select the desired kilohertz (kHz) value. For example, the '.80' portion of the frequency '117.80' (Figure 9-4).



Figure 9-4 Select VOR Kilohertz Frequency

- To make the standby frequency the active frequency, press the **VLOC Flip-flop** Key.

## Auto-Tuning

A frequency may also be quickly selected from the database by simply highlighting the desired frequency on the VOR Page (Section 7.10) or the Nearest VOR Page (Section 8.5) and pressing the **ENT** Key. This process is referred to as auto-tuning. Once a frequency is selected in the standby field, it may be transferred to the active frequency by pressing the **VLOC Flip-flop** Key. (Auto-tuning can also be performed from VLOC frequencies listed on the NAV/COM Page, the Airport Frequency Page, and the Nearest Flight Service Station Page.)

### To select a VLOC frequency from the VOR Page or Nearest VOR Page:

- Select the desired page from the main pages (as discussed in the preceding paragraph).
- Press the small **right** knob momentarily to activate the flashing cursor
- Turn the large right knob to highlight the frequency for the desired VOR (Figure 9-5).



Figure 9-5 Highlight Frequency

- 4) Press the **ENT** Key to place the frequency in the standby field of the VLOC Window (Figure 9-6).



Figure 9-6 Frequency in Standby Field

- 5) Press the **VLOC Flip-flop** Key to activate the selected frequency.
- 6) Press the small **right** knob to remove the flashing cursor.



**NOTE:** For duplex COM operations, the VLOC receiver may be auto-tuned from the Nearest Flight Service Station Page. See Section 8.8 for more info.

When selecting a VOR or ILS approach, manual tuning of the VLOC receiver is not required. Once the approach procedure is 'Loaded' or 'Activated', the GNS 430 automatically places the proper frequency in the standby field of the VLOC Window. To use this frequency, press the **VLOC Flip-flop** Key to activate the frequency. Additional information on approach procedures is provided in Section 6.1.

### To select an approach and automatically tune the proper VLOC frequency:

- 1) Select the destination airport using the **Direct-to** Key or as the last waypoint in the active flight plan.
- 2) Press the **PROC** Key to display the Procedures Page.
- 3) Turn the large **right** knob to highlight 'Select Approach?' and press the **ENT** Key (Figure 9-7).

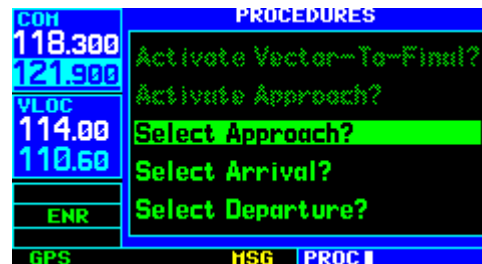

Figure 9-7 Procedures Page

- 4) A window appears listing the available procedures. Turn the small **right** knob to highlight the desired procedure and press the **ENT** Key. (When a direct-to destination is selected, departures are offered for the nearest airport.)
- 5) A second window appears listing available transitions. Turn the small **right** knob to highlight the desired transition waypoint and press the **ENT** Key. (The approach 'Vectors' option assumes the pilot will receive vectors to the final course segment of the approach and will provide navigation guidance to intercept this final course.)

- Turn the large **right** knob to highlight 'Load?' or 'Activate?' (Figure 9-8) and press the **ENT** Key. ('Load?' adds the procedure to the flight plan without immediately using it for navigation guidance. This allows the pilot to continue navigating the original flight plan, but keeps the procedure available on the Active Flight Plan Page for quick activation when needed.)



Figure 9-8 Highlight 'Load?'

- For VOR and ILS approaches, the standby field of the VLOC Window is automatically tuned to the proper frequency. To activate the frequency press the **VLOC Flip-flop** Key. To display VLOC course information on the external CDI (or HSI) press the **CDI** Key and verify that 'VLOC' is displayed at the bottom left corner of the screen, directly above the **CLR** Key.
- For precision approaches and some non-precision approaches, a reminder window appears indicating that GPS guidance on such approaches is strictly for monitoring only—use the VLOC receivers and external CDI (or HSI) for primary navigation. To confirm this reminder, highlight 'Yes?' and press the **ENT** Key.

### CDI Key

The GNS 430's **CDI** Key is used to couple the GPS or VLOC receiver to the external CDI (or HSI). When the external CDI (or HSI) is being driven by the GPS receiver, 'GPS' appears at the bottom left corner of the page, directly above the **CDI** Key. When the external CDI (or HSI) is being driven by the VLOC receiver, 'VLOC' appears instead.

To couple the external CDI (or HSI) to the GPS receiver or VLOC receiver, press the **CDI** Key to display 'GPS' or 'VLOC', as desired (Figures 9-9 and 9-10).



↳ 'GPS' Annunciator

Figure 9-9 GPS Coupled to External CDI



↳ 'VLOC' Annunciator

Figure 9-10 VLOC Coupled to External CDI



**NOTE:** The external CDI (or HSI) must be coupled to the VLOC receiver for approaches which are not approved for GPS. See ILS example in Section 6.3.

## SECTION 10: AUX PAGES

### 10.1 AUX PAGE GROUP

Section 3.1 introduced the GNS 430's main page groups (Table 10-1)—NAV, WPT, AUX, NRST—and described each page in the NAV group. The third page group (AUX) allows the pilot to change unit settings. The AUX pages (Figure 10-1) also provide E6B functions, such as trip planning, fuel planning, density altitude, true airspeed, and winds aloft calculations.

| Page Groups   |               |             |               |
|---------------|---------------|-------------|---------------|
| NAV Group     | WPT Group     | AUX Group   | NRST Group    |
| see Section 3 | see Section 7 | 4 AUX pages | see Section 8 |

Table 10-1 Page Groups



Figure 10-1 AUX Pages

To quickly select an AUX page:

- 1) From any page, press and hold the **CLR** Key to select the Default NAV Page (Figure 10-2). If any of the main pages are already being displayed, this step may be skipped.



Figure 10-2 Default NAV Page

- 2) Turn the large **right** knob to select the AUX Page Group (Figure 10-3). 'AUX' appears in the lower right corner of the screen.

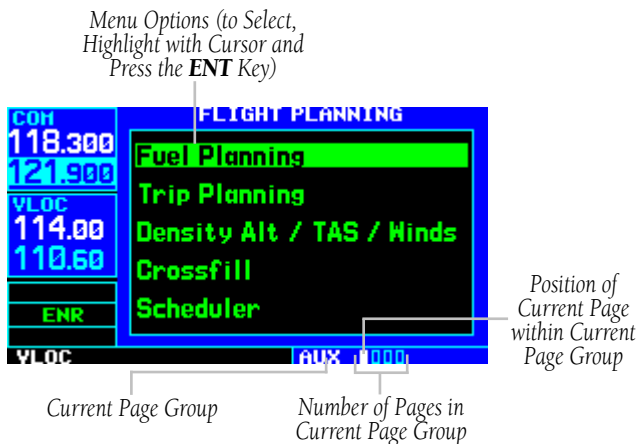

Figure 10-3 Flight Planning Page

- 3) Turn the small **right** knob to select the desired AUX page.

**10.2 FLIGHT PLANNING PAGE**

The Flight Planning Page (Figure 10-4) provides access (via ‘menu options’) to E6B functions for fuel planning, trip planning, density altitude/true airspeed/winds aloft calculations and a ‘Crossfill’ function to transfer flight plans/user waypoints to a second GNS 430. When a menu option is selected, the corresponding page appears providing additional information and features.

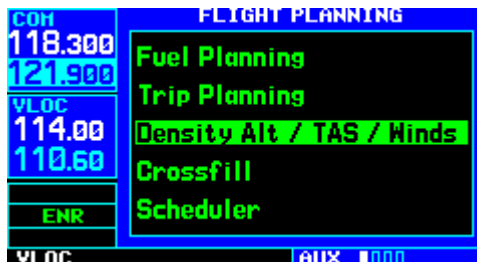

**Figure 10-4 Flight Planning Page**

**To select a menu option from the Flight Planning Page:**

- 1) Press the small **right** knob momentarily, to activate the flashing cursor (Figure 10-4).

- 2) Turn the large **right** knob to select the desired menu option (Figure 10-5), and press the **ENT** Key (Figure 10-6).



**Figure 10-5 Density Alt/TAS/Winds Highlighted**

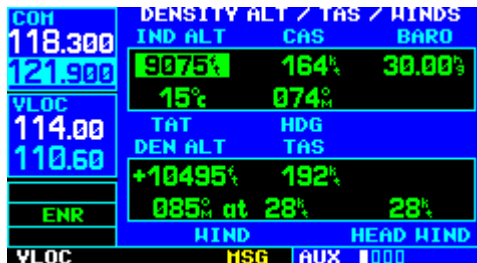

**Figure 10-6 Density Alt/TAS/Winds Page**



The following menu options are available:

- Fuel Planning - When equipped with fuel flow (FF) and/or fuel on board (FOB) sensors, this option displays current fuel conditions along the active direct-to or flight plan. The pilot may also manually enter fuel flow, ground speed (GS) and (in some instances) fuel on board figures for planning purposes. Fuel planning figures can be displayed not only for the currently active flight plan or direct-to, but also point-to-point between two specified waypoints and for any programmed flight plan.
- Trip Planning - Allows the pilot to view desired track (DTK), distance (DIS), estimated time enroute (ETE), enroute safe altitude (ESA), and estimated time of arrival (ETA) information for a direct-to, point-to-point between two specified waypoints, or for any programmed flight plan.



---

**NOTE:** *Point-to-point waypoints, flight plans, and/or ground speed (default is current GPS-calculated ground speed) entered on the Fuel Planning Page automatically transfers to the Trip Planning Page, and vice versa.*

---

- Density Alt/TAS/Winds - Indicates the theoretical altitude at which the aircraft can perform depending upon several environmental conditions, including indicated altitude (IND ALT), barometric pressure (BARO), and total air temperature (TAT; the temperature, including the heating effect of speed, read on a standard outside temperature gauge). This menu option computes true airspeed (TAS), based upon the factors above and the calibrated airspeed (CAS). Also, this menu option determines winds aloft (the wind direction and speed) and a head wind/tail wind component, based upon the calculated density altitude (DEN ALT), true airspeed, aircraft heading (HDG), and ground speed.
- Crossfill - Allows the pilot to transfer the active flight plan, any stored flight plan, a user waypoint, or all user waypoints between two 400-Series Garmin units (GNS 430/GNC 420/GPS 400) in a dual-unit installation. See Section 5.1, Flight Plan Catalog Options and information following in this section for details.
- Scheduler - Displays reminder messages (such as 'Change oil', 'Switch fuel tanks', 'Overhaul', etc.). One-time, periodic, and event-based messages are allowed. One-time messages appear once the timer expires and reappear each time the GNS 430 is powered on, until the message is deleted. Periodic messages automatically reset to the original timer value, once the message is displayed. Event-based messages do not use a timer, but rather a specific date and time.

### Flight Planning Page: Fuel Planning

**To perform fuel planning operations:**

- 1) Select 'Fuel Planning' from the Flight Planning Page, using the steps described in Section 10.2.
- 2) The current fuel planning 'mode' is displayed at the top of the page (Figure 10-7): 'POINT TO POINT' or 'FPL' (for a flight plan). To change the mode, press the **MENU** Key to display the Fuel Planning Page Menu (Figure 10-8) for the other mode, then press the **ENT** Key to accept the other mode.

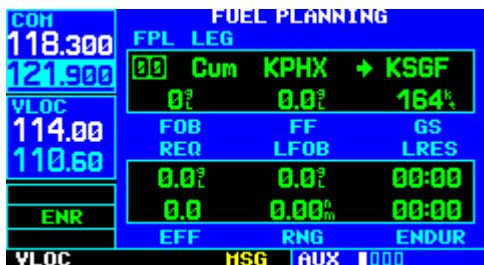

Figure 10-7 Fuel Planning Page



Figure 10-8 Fuel Planning Page Menu

- 3) For point-to-point fuel planning (Figure 10-9), turn the small and large **right** knobs to enter the identifier of the 'from' waypoint. Once the waypoint's identifier is entered, press the **ENT** Key to accept the waypoint. The flashing cursor moves to the 'to' waypoint. Again, turn the small and large **right** knobs to enter the identifier of the 'to' waypoint and press the **ENT** Key to accept the waypoint. **OR**,

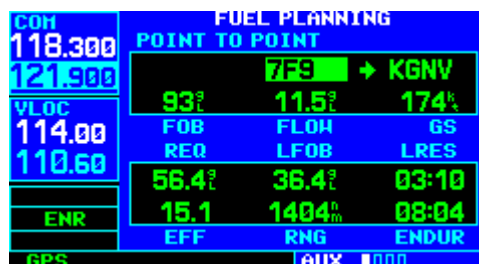

Figure 10-9 Fuel Planning Page, Point-to-Point

- 4) For flight plan fuel planning (Figure 10-10), turn the small **right** knob to select the desired flight plan by number (already stored in memory; 00 is the active flight plan). Turn the large **right** knob to highlight the 'LEG' field and turn the small **right** knob to select the desired leg of the flight plan, or select 'Cum' to apply fuel planning calculations to the entire flight plan.

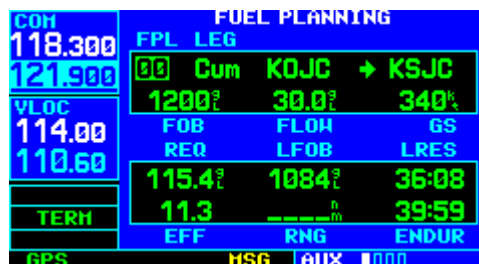

Figure 10-10 Fuel Planning Page Flight Plan

- If the fuel management system does not enter the data automatically, turn the large **right** knob to highlight the fuel on board (FOB) field (Figure 10-11).



Figure 10-11 FOB Highlighted

- Use the small and large **right** knobs to enter the amount of fuel on board. Press the **ENT** Key when finished.
- The flashing cursor moves to the fuel flow (FF) field. Use the small and large **right** knobs to enter the fuel flow rate. Press the **ENT** Key when finished. Note that if a fuel system is providing current fuel flow, the fuel flow field defaults to this value.
- The flashing cursor moves to the ground speed (GS) field. Use the small and large **right** knobs to enter the ground speed. Press the **ENT** Key when finished.
- With all variables entered, the following information is provided (Figure 10-12):

- REQ - Quantity of fuel required
- LFOB - Left-over fuel on board
- LRES - Left-over fuel reserve time
- EFF - Efficiency, expressed in distance per fuel units (e.g., nautical miles per gallon)
- RNG - Range (distance)
- ENDUR - Flight endurance, or total available flight time

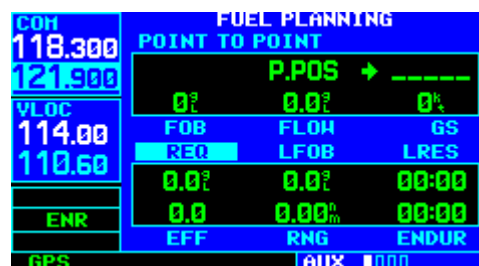

Figure 10-12 REQ Highlighted

- To re-configure the data fields press the **MENU** Key to display the options window (Figure 10-13). Turn the small **right** knob to highlight the 'change fields?' option. Press the **ENT** Key to re-configure the data fields. Turn the large **right** knob to select the desired field. Turn the small **right** knob to highlight the desired data. Press the **ENT** Key to select the data configuration.



Figure 10-13 Select Field Type Window

**Fuel planning figures can be entered and displayed based upon one of three possible configurations:**

- 1) No fuel sensors connected - In this instance fuel flow is manually entered and is used to calculate fuel on board. When fuel flow or fuel on board is manually entered, the figures are retained the next time the page is displayed (with fuel on board continuously recalculated).
- 2) Fuel flow sensor installed, but no fuel on board sensor - Fuel on board is manually entered. Fuel flow is automatically provided by sensor. If fuel flow is manually entered (to override the sensor), it does not affect the FOB figure and is not retained the next time the page is displayed.
- 3) Fuel flow and fuel on board sensors installed - Fuel flow and fuel on board are automatically provided by sensors. Fuel on board can NOT be entered manually. Fuel flow can be entered manually, but does not affect the FOB figure and is not retained the next time the page is displayed.

**Flight Planning Page: Trip Planning**

**To perform trip planning operations:**

- 1) Select 'Trip Planning' from the Flight Planning Page, using the steps described in this section.
- 2) The current trip planning 'leg mode' is displayed at the top of the page: 'POINT TO POINT' or 'FPL LEG' (for a flight plan leg). To change the leg mode, press the **MENU** Key to display the Flight Planning Page Menu for the other leg mode, then press the **ENT** Key to accept the other leg mode.

- 3) For point-to-point trip planning, turn the small and large **right** knobs to enter the identifier of the 'from' waypoint. Once the waypoint's identifier is entered, press the **ENT** Key to accept the waypoint. The flashing cursor moves to the 'to' waypoint (Figure 10-14). Again, turn the small and large **right** knobs to enter the identifier of the 'to' waypoint and press the **ENT** Key to accept the waypoint. **OR**,



Figure 10-14 Trip Planning Page, Point-to-Point

- 4) For 'flight plan leg' trip planning, turn the small **right** knob to select the desired flight plan (already stored in memory), by number. Turn the large **right** knob to highlight the 'LEG' field (Figure 10-15) and turn the small **right** knob to select the desired leg of the flight plan, or select 'Cum' to apply trip planning calculations to the entire flight plan.



Figure 10-15 Trip Planning Page, Flight Plan Leg

- 5) Turn the large **right** knob to highlight the departure time (DEP TIME) field.
- 6) Use the small and large **right** knobs to enter the departure time. Press the **ENT** Key when finished. (Departure time may be entered in local or UTC time, depending upon unit settings, see Section 10.4, Setup 1 Page: Date/Time.)
- 7) The flashing cursor moves to the ground speed (GS) field. Use the small and large **right** knobs to enter the ground speed. Press the **ENT** Key when finished.
- 8) With all variables entered, the following information is provided (Figure 10-16):



Figure 10-16 Trip Planning Page

- DTK - Desired track or desired course
- DIS - Distance
- ETE - Estimated time enroute
- ESA - Enroute safe altitude
- ETA - Estimated time of arrival

## Flight Planning Page: Density Alt/TAS/Winds

To calculate density altitude, true airspeed, winds aloft:

- 1) Select 'Density Alt/TAS/Winds' from the Flight Planning Page (Figure 10-17), using the steps described at the beginning of this section.



Figure 10-17 Density Alt/TAS/Winds Highlighted

- 2) The flashing cursor highlights the indicated altitude (IND ALT) field. Use the small and large **right** knobs to enter the altitude indicated on the altimeter. Press the **ENT** Key when finished.
- 3) The flashing cursor moves to the calibrated airspeed (CAS) field (Figure 10-18). Use the small and large **right** knobs to enter the airspeed from the airspeed indicator. Press the **ENT** Key when finished.

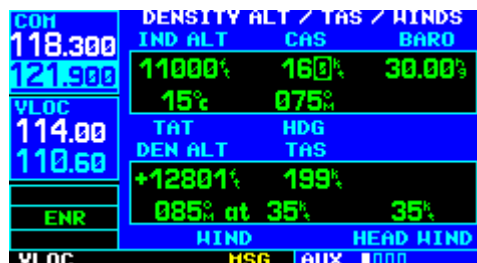

Figure 10-18 Calibrated Airspeed Field Selected

- 4) The flashing cursor moves to the barometric pressure (BARO) field. Use the small and large **right** knobs to enter the barometric pressure (altimeter setting). Press the **ENT** Key when finished.
- 5) The flashing cursor moves to the total air temperature (TAT) field. Use the small and large **right** knobs to enter the temperature. Press the **ENT** Key when finished.
- 6) The flashing cursor moves to the aircraft heading (HDG) field. Use the small and large **right** knobs to enter the aircraft heading (Figure 10-19) from the directional gyro or compass. Press the **ENT** Key when finished.



Figure 10-19 Heading Field Highlighted

- 7) With all variables entered, the following information is provided:
  - DEN ALT - Density altitude
  - TAS - True airspeed
  - WIND - Wind direction and speed
  - HEAD/TAIL WIND - Magnitude of head wind or tail wind component



*NOTE: If the installation includes components (such as an airdata sensor) to provide any of the variables above, the Density Alt/TAS/Winds Page data defaults to the values provided by these components.*

## Flight Planning Page: Crossfill

Select 'Crossfill?' from the Flight Planning Page (Figure 10-20), the Default NAV Page (Figure 10-21), or Active Flight Plan Page (Figure 10-22), by pressing the **MENU** Key, and then scrolling down to 'Crossfill?' and pressing the **ENT** key.



Figure 10-20 Flight Planning Page



Figure 10-21 Default NAV Page Menu



Figure 10-22 Flight Plan Page Menu

- Automatic Operation - If both units are set to automatic, a change in the active flight plan of one unit is also be seen in the other. Initiating a direct-to to a waypoint on one unit also initiates a direct-to to the same waypoint on the other unit.

If one unit is set for automatic crossfill and the other is set for manual crossfill, then only the auto unit automatically sends data to the manual unit. In this configuration, the auto unit could be thought of as the master unit.

- Manual Operation - If manual operation is desired, the pilot must invoke all transfers from that unit. When a unit is configured for automatic transfer, a manual transfer can also be done on command. If either of the messages 'data transfer error' or 'data transfer cancelled' are received during an automatic or manual transfer, the pilot must force another transfer.

### To transfer flight plans or user waypoints to/from a second 400 Series unit:

- 1) Select 'Crossfill' from the Flight Planning Page, using the steps described at the beginning of this section.
- 2) The flashing cursor highlights the method field. Turn the small **right** knob to select 'Auto' or 'Manual' (Figure 10-23). 'Auto' automatically transfers any selection of (or any change to) a direct-to destination or active flight plan to a second 400 or 500 Series Garmin unit.

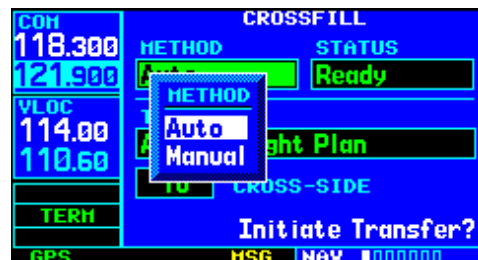

Figure 10-23 Crossfill Method Window



*NOTE: Crossfill requires both 400 and/or 500 Series units to have the same Jeppesen NavData database cycle number.*

- 3) The flashing cursor highlights the transfer data option (TRANSFER) field (Figure 10-24). Turn the small **right** knob to display a window of available data options (Figure 10-25).

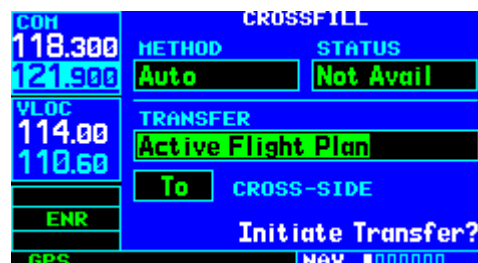

Figure 10-24 Transfer Field Highlighted

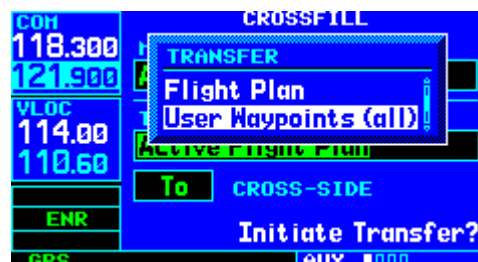

Figure 10-25 Transfer Window

- Active Flight Plan - Transfer the active flight plan to/from a second 400-Series Garmin unit (GNS 430/GNC 420/GPS 400) in a dual unit installation. This option is the default when selecting 'Crossfill' from the Active Flight Plan Page.
  - Flight Plan - Transfer any stored flight plan to/from a second 400-Series unit, by selecting the flight plan by number. This option is the default when selecting 'Crossfill' from the Flight Plan Catalog Page. See also Section 5.1, Flight Plan Catalog Page Options.
  - User Waypoints (all) - Transfer all stored user waypoints to/from a second 400-Series unit.
  - User Waypoint - Transfer the specified user waypoint to a second 400-Series unit.
- 4) Continue turning the small **right** knob to select the desired data option. Press the **ENT** Key when finished.
  - 5) For a stored flight plan ('Flight Plan' data option), the flight plan number field is highlighted. Turn the small **right** knob to select the desired flight plan and press the **ENT** Key.
  - 6) For a specified user waypoint ('User Waypoint' data option), the waypoint identifier field is highlighted. Use the small and large **right** knobs to enter the identifier of the desired user waypoint. Press the **ENT** Key when finished.
  - 7) The flashing cursor moves to the 'CROSS-SIDE' field. Turn the small **right** knob to select 'To' or 'From' and press the **ENT** Key.

- 8) The flashing cursor moves to the 'Initiate Transfer?' confirmation field (Figure 10-26). Press the **ENT** Key to transfer the selected data.

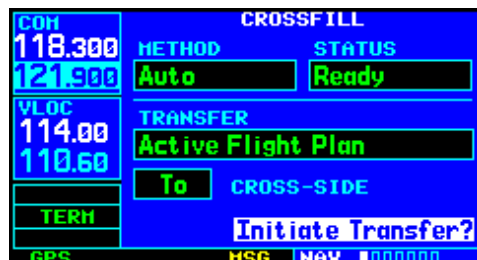

Figure 10-26 'Initiate Transfer' Highlighted

## Flight Planning Page: Scheduler

### To enter a scheduled message:

- 1) Select 'Scheduler' from the Flight Planning Page, using the steps described in this section.
- 2) The flashing cursor highlights the first message field. If necessary, turn the large **right** knob to highlight the first blank message field.
- 3) Use the small and large **right** knobs to enter the message text. Press the **ENT** Key when finished. (The GNS 430 stores up to nine scheduled messages holding 20 characters each.)



- 4) The flashing cursor moves to the type field under the new message (Figure 10-27). Turn the small **right** knob to display a window of available options, (Figure 10-28): Event, One Time, Periodic. Press the **ENT** Key to select.



Figure 10-27 Type Field Highlighted

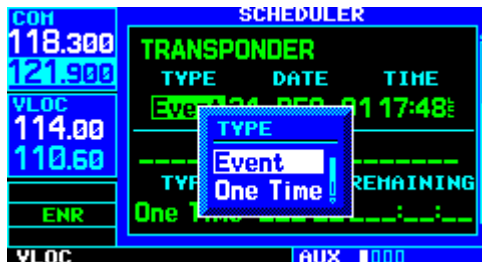

Figure 10-28 Type Window

- 5) The flashing cursor moves to the time/date field. Use the small and large **right** knobs to set the time or date required before the message is displayed. Time is entered as hours/minutes/seconds (hhh:mm:ss). Event-based messages expire at a specific date and time. Press the **ENT** Key when finished.

#### To edit a scheduled message:

- 1) Select 'Scheduler' from the Flight Planning Page, using the steps described at the beginning of this section.
- 2) The flashing cursor highlights the first message field.
- 3) To edit the message text, turn the large **right** knob to highlight the desired message field. Use the small and large **right** knobs to edit the message text—entering the new text directly over the old message. Press the **ENT** Key when finished.
- 4) To edit the time field, turn the large **right** knob to highlight the field. Use the small and large **right** knobs to edit the new date or time—entering the new value directly over the old figure. Press the **ENT** Key when finished.

#### To delete a scheduled message:

- 1) Select 'Scheduler' from the Flight Planning Page, using the steps described in this section.
- 2) The flashing cursor highlights the first message field. Turn the large **right** knob to highlight the desired message field.
- 3) Press the **CLR** Key to delete the message text, followed by the **ENT** Key to confirm the deletion.

### 10.3 UTILITY PAGE

The Utility Page (Figure 10-29) provides access (via 'menu options') to checklists, a count down/up timer, trip timers, trip statistics, RAIM (Receiver Autonomous Integrity Monitoring) prediction, sunrise/sunset time calculations, software versions, database versions, and terrain database version information. When a menu option is selected, the corresponding page appears providing additional information and features.



**NOTE:** Scroll down to view the last 3 items (Software Versions, Database Versions, and Terrain Database Versions) listed on the Utility Page.

Menu Options (to Select, Highlight with Cursor and Press the ENT Key)

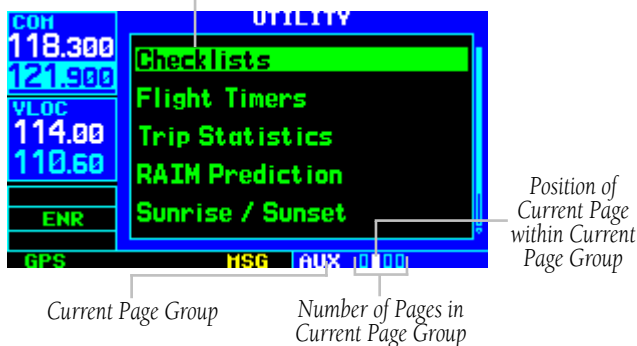

**Figure 10-29 Utility Page**

#### To select a menu option from the Utility Page:

- 1) Press the small **right** knob momentarily, to activate the flashing cursor (Figure 10-29).

- 2) Turn the large **right** knob to select the desired menu option (Figure 10-30), and press the **ENT** Key (Figure 10-31).



**Figure 10-30 Sunrise/Sunset Highlighted**

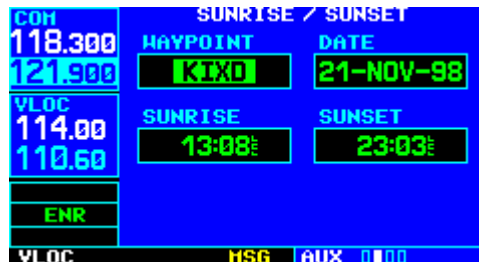

**Figure 10-31 Waypoint Field Highlighted**

The following menu options are available:

- Checklists - Provides up to nine different user-defined checklists containing up to 30 items each.
- Flight Timers - Provides count up/down timers, plus automatic recording of departure time and total trip time. Departure and total trip time recording can be configured to run either any time GNS 430 power is on, or only when the ground speed exceeds 30 knots.
- Trip Statistics - Provides readouts for trip odometers, average speed, and maximum speed. These readouts are resettable (individually or all at once) by pressing the **MENU** Key to display the Trip Statistics Page Menu.

- RAIM Prediction - Predicts if GPS coverage is available for the current location or at a specified waypoint at any time and date. Receiver Autonomous Integrity Monitoring (RAIM) performs checks to ensure that the GNS 430 will have adequate satellite geometry during the flight. RAIM availability is near 100% in Oceanic, Enroute, and Terminal phases of flight. Because the FAA's TSO requirements for non-precision approaches specify significantly better satellite coverage than other flight phases, RAIM may not be available when flying some approaches. The GNS 430 automatically monitors RAIM during approach operations and warns the pilot if RAIM is not available. In such cases, use the GNS 430's VLOC receiver instead for many of the non-precision and precision approaches stored on the Jeppesen NavData card. RAIM prediction helps the pilot plan for a pending flight to confirm GPS operation during an approach.

An 'INTEG' annunciation at the bottom left corner of the screen (Figure 10-32) indicates that satellite coverage is insufficient to pass built-in (RAIM) tests. When this occurs, the GPS receiver continues to provide navigation information, but should not be used for primary navigation guidance. Use the GNS 430's VLOC receiver or another suitable navigation source.

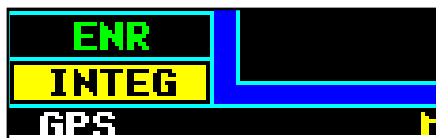

Figure 10-32 'INTEG' Annunciation

If a 'WARN' annunciation appears at the bottom left corner, GPS satellite coverage may be sufficient, but the GNS 430 has detected a position error which exceeds protection limits. In this condition, all GPS navigation data on the GNS 430 is disabled. Use the GNS 430's VLOC receiver or an alternate navigation source.

- Sunrise/Sunset - Allows the pilot to calculate the time of sunrise and sunset at any waypoint or the present position for a specified date.
- Software Versions - Provides software version information for the operating software within the GPS receiver, COM transceiver, VOR/localizer receiver, glideslope receiver, and main processor board.
- Database Versions - Displays the current Jeppesen database type and expiration date, along with the version and type of built-in land database.
- Terrain Database Versions - Displays the current version and area of coverage of each terrain and obstacle database. If a database is found to be missing and/or deficient, the TERRAIN system fails the self-test and issues a failure message.

## Utility Page: Checklists

### To create a checklist:

- 1) Select 'Checklist' from the Utility Page (Figure 10-33), using the steps described at the beginning of this section (10.3). Press the **ENT** Key to display a list of checklists.

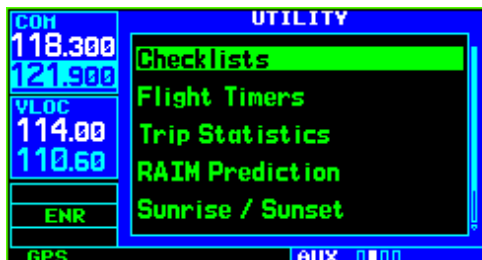

Figure 10-33 Checklists Highlighted

- 2) Press the **MENU** Key to display an options menu. Turn the large **right knob** to select 'Create New Checklist?' and press the **ENT** Key.
- 3) Use the small and large **right** knobs to enter the name of a checklist. Press the **ENT** Key when finished. (Up to nine different checklists can be created and stored in the GNS 430.)
- 4) Use the small and large **right** knobs to enter each checklist item, followed each time by the **ENT** Key. (Each checklist may contain up to 30 line items of as much as 16 characters long.)

### To execute a checklist:

- 1) With the Checklists Page displayed (Figure 10-34), turn the large **right knob** to select the desired checklist and press the **ENT** Key.



Figure 10-34 Desired Checklist Highlighted

- 2) As each checklist item is completed, press the **ENT** Key to move to the next item on the list (Figure 10-35).



Figure 10-35 Desired Checklist Item Highlighted

### To edit a checklist:

- 1) With the Checklists Page displayed, turn the large **right knob** to select the desired checklist and press the **ENT** Key.
- 2) Press the **MENU** Key to display an options menu. Select 'Edit Item?' and press the **ENT** Key, then use the small and large **right** knobs to edit each checklist item. Press the **ENT** Key when finished.

**To insert a checklist step into an existing checklist:**

- 1) With the Checklists Page displayed, turn the large **right** knob to select the desired checklist and press the **ENT** Key.
- 2) Turn the large **right** knob to highlight the existing checklist entry which immediately follows the new checklist step.
- 3) Turn the small and large **right** knobs to enter the new checklist step. Press the **ENT** Key when finished.

**To delete a checklist or all checklists:**

- 1) With the Checklists Page displayed, press the **MENU** Key to display an options menu.
- 2) Turn the large **right** knob to select 'delete checklist' or 'delete all checklists' and press the **ENT** Key to remove the checklist or all checklists from memory.

**To copy a checklist:**

- 1) With the Checklists Page displayed and the desired checklist selected, press the **MENU** Key.
- 2) Turn the large **right** knob to select 'Copy Checklist?' and press the **ENT** Key to copy the checklist to an empty checklist memory location.

**To sort the checklists by name or entry:**

- 1) With the Checklists Page displayed, press the **MENU** Key to display an options menu.
- 2) Turn the large **right** knob to select 'Sort List By Entry?' or 'Sort List By Name?' and press the **ENT** Key.

**Utility Page: Flight Timers****To view, use, or reset the generic timer:**

- 1) Select 'Flight Timers' from the Utility Page (Figure 10-36), using the steps described at the beginning of this section (10.3).

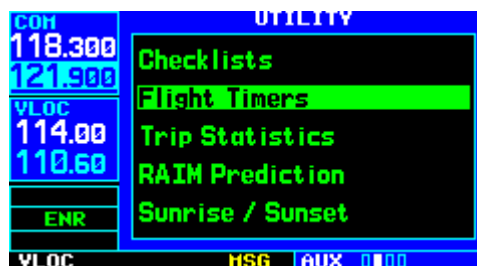

Figure 10-36 Flight Timers Highlighted

- 2) The flashing cursor highlights 'Start?'. To start the generic timer, press the **ENT** Key. (Count up timers typically begin with this step; however, for count down timers, to enter a count direction and time before starting the timer, see the following steps.)
- 3) To change the count direction, turn the large **right** knob to highlight the count direction field (Figure 10-37): 'Down' or 'Up'. Turn the small **right** knob to select the desired count direction. Press the **ENT** Key when finished.

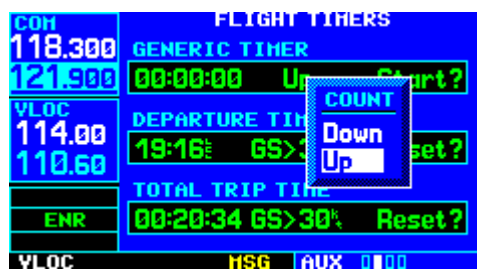

Figure 10-37 Count Window

- 4) For a count down timer, turn the large **right** knob to highlight the time field. Use the small and large **right** knobs to enter the count down time—in hours, minutes, and seconds. Press the **ENT** Key when finished.
- 5) To stop the generic timer, turn the large **right** knob to highlight 'Stop?' and press the **ENT** Key.
- 6) To reset the generic timer, turn the large **right** knob to highlight the time field. Press the **CLR** Key, followed by the **ENT** Key.

**To record or reset the departure time:**

- 1) Select 'Flight Timers' from the Utility Page, using the steps described at the beginning of this section (10.3).
- 2) Turn the large **right** knob to highlight the reset mode field, under 'Departure Time'. (The reset mode field indicates 'Pwr-on' or 'GS>30kt'.)
- 3) Turn the small **right** knob to select the desired reset mode (Figure 10-38). ('Pwr-on' records a departure time when the GNS 430 is turned on. 'GS>30kt' records a departure time once the GPS-computed ground speed exceeds 30 knots.)



Figure 10-38 Reset Mode Window

- 4) Press the **ENT** Key when finished.
- 5) To reset the departure time, turn the large **right** knob to highlight 'Reset?' and press the **ENT** Key.

**To view, use or reset total trip time:**

- 1) Select 'Flight Timers' from the Utility Page, using the steps described at the beginning of this section.
- 2) Turn the large **right** knob to highlight the reset mode field, under 'Total Trip Time'. (The reset mode field indicates 'Pwr-on' or 'GS>30kt'.)
- 3) Turn the small **right** knob to select the desired reset mode. ('Pwr-on' records trip time, in hours/minutes/seconds, any time the GNS 430 is turned on. 'GS>30kt' records trip time any time the GPS-computed ground speed exceeds 30 knots.)
- 4) Press the **ENT** Key when finished.
- 5) To reset the total trip time, turn the large **right** knob to highlight 'Reset?' (Figure 10-39) and press the **ENT** Key.



Figure 10-39 'Reset?' Highlighted

## Utility Page: Trip Statistics

To reset trip statistics readouts:

- 1) Select 'Trip Statistics' from the Utility Page (Figure 10-40), using the steps described at the beginning of this section.

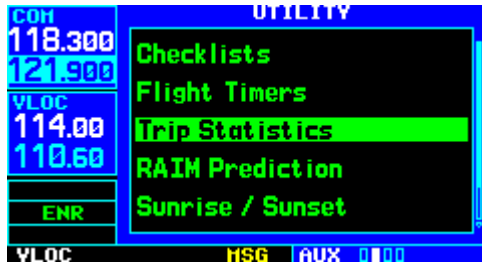

Figure 10-40 Trip Statistics Highlighted

- 2) Press the **MENU** Key to display the Trip Statistics Page Menu (Figure 10-41):

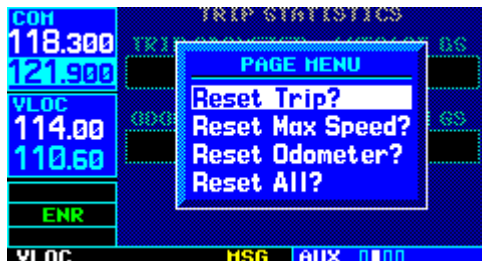

Figure 10-41 Trip Statistics Page Menu

- Reset Trip? - Resets trip odometer and average ground speed readouts
  - Reset Max Speed? - Resets maximum speed readout only
  - Reset Odometer? - Resets odometer readout only
  - Reset All? - Resets all trip statistics readouts
- 3) Turn the large right knob to select the desired reset option and press the **ENT** Key.

## Utility Page: RAIM Prediction

To predict RAIM availability:

- 1) Select 'RAIM Prediction' from the Utility Page (Figure 10-42), using the steps described at the beginning of this section.

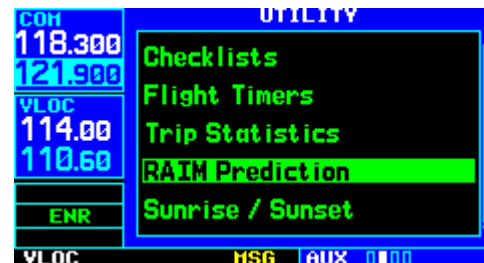

Figure 10-42 RAIM Prediction Highlighted

- 2) The flashing cursor highlights the waypoint field (Figure 10-43). Use the small and large **right** knobs to enter the identifier of the waypoint at which the pilot wants to determine RAIM availability. Press the **ENT** Key when finished. (To determine RAIM availability for the present position, press the **CLR** Key, followed by the **ENT** Key.)

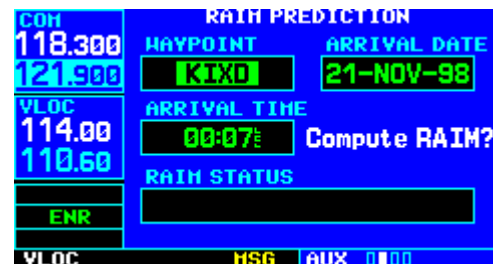

Figure 10-43 RAIM Prediction Page

- 3) The flashing cursor moves to the arrival date field. Use the small and large **right** knobs to enter the date for which the pilot wants to determine RAIM availability. Press the **ENT** Key when finished.
- 4) The flashing cursor moves to the arrival time field. Use the small and large **right** knobs to enter the time for which the pilot wants to determine RAIM availability. Press the **ENT** Key when finished.
- 5) The flashing cursor moves to 'Compute RAIM?' (Figure 10-44). Press the **ENT** Key to begin RAIM prediction. Once calculations are complete, the GNS 430 displays one of the following in the RAIM status field:

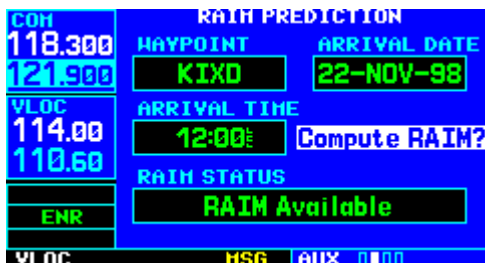

Figure 10-44 'Compute RAIM?' Highlighted

- RAIM Not Available - Satellite coverage is predicted to NOT be sufficient for reliable operation during non-precision approaches
- RAIM Available - Satellite coverage is predicted to be sufficient for reliable operation during all flight phases, including non-precision approaches



*NOTE: RAIM computations predict satellite coverage within ±15 minutes of the specified arrival date and time. Refer to Section 10.4 for specific information regarding RAIM protection limits, also refer to Section 12 for FDE (Fault Detection and Exclusion) information.*

### Utility Page: Sunrise/Sunset

**To calculate sunrise and sunset times at any waypoint or the present position:**

- 1) Select 'Sunrise/Sunset' from the Utility Page, using the steps described at the beginning of this section (Figure 10-45).

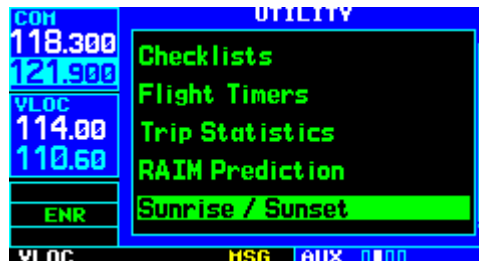

Figure 10-45 Sunrise Sunset Highlighted

- 2) The flashing cursor highlights the waypoint field. Use the small and large **right** knobs to enter the identifier of the waypoint at which the pilot wants to determine sunrise and sunset times. Press the **ENT** Key when finished. (To determine sunrise/sunset times for the present position, press the **CLR** Key, followed by the **ENT** Key.)
- 3) The flashing cursor moves to the date field (Figure 10-46). Use the small and large **right** knobs to enter the date for which the pilot wants to determine sunrise and sunset times.

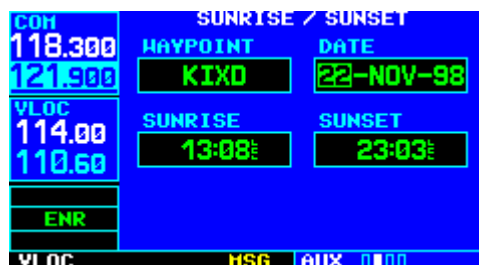

Figure 10-46 Date Field Highlighted



- 4) Press the **ENT** Key to calculate sunrise and sunset times for the selected location and date (Figure 10-47).

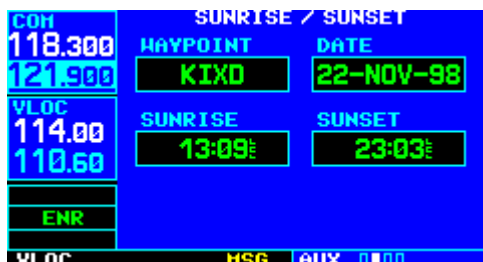

Figure 10-47 Sunrise/Sunset Page

### Utility Page: Software Versions

The Software Versions Page (Figure 10-48) displays software version information for each of the various subsystems contained within the GNS 430. This page is for information purposes only—no user functions are available from this page.

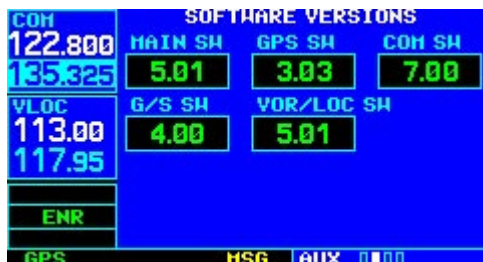

Figure 10-48 Software Versions Page

### Utility Page: Database Versions

The Database Versions Page (Figure 10-49) displays the navigation database type and version information as well as the land database type and version. This page is for information purposes only—no user functions are available from this page.



Figure 10-49 Database Versions Page

### Utility Page: Terrain Database Versions

The Terrain Database Versions Page (Figure 10-50) displays the current version and area of coverage of each terrain and obstacle database. This page is for information purposes only—no user functions are available from this page.



Figure 10-50 Terrain Database Versions Page

## 10.4 SETUP 1 PAGE

The Setup 1 Page (Figure 10-51) provides access (via ‘menu options’) to airspace alarms, CDI scale adjustment, an arrival alarm, units of measure settings, position formats, map datums, and settings for local or UTC time display. When a menu option is selected, the corresponding page appears providing access to the various unit settings.

### To select a menu option from the Setup 1 Page:

*Menu Options (to Select, Highlight with Cursor and Press the ENT Key)*

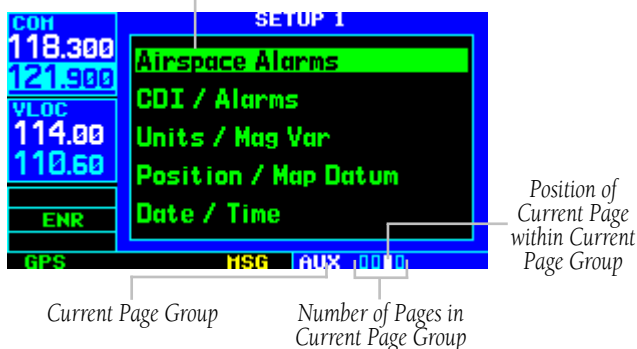

**Figure 10-51 Setup 1 Page**

- 1) Press the small **right** knob momentarily, to activate the flashing cursor (Figure 10-51).
- 2) Turn the large **right** knob to select the desired menu option (Figure 10-52), and press the **ENT** Key (Figure 10-53).



**Figure 10-52 'Units/Mag Var' Highlighted**



**Figure 10-53 Units/Mag Var Page**

The following menu options are available:

- ‘Airspace Alarms’ - Allows the pilot to turn the controlled/special-use airspace message alerts on or off. This does not affect the alerts listed on the Nearest Airspace Page or the airspace boundaries depicted on the Map Page. It simply turns on/off the warning provided when the aircraft is approaching or near an airspace.

An altitude buffer is also provided which ‘expands’ the vertical range above or below an airspace. For example, if the buffer is set at 500 feet, and the aircraft is more than 500 feet above or below an airspace, the pilot is not notified with an alert message; if the aircraft is less than 500 feet above or below an airspace and projected to enter it, the pilot is notified with an alert message. The default is 200 feet.

- ‘CDI/Alarms’ - Allows the pilot to define the scale for the GNS 430’s on-screen course deviation indicator. The scale values represent full scale deflection for the CDI to either side (Figure 10-54). The default setting is ‘Auto’. At this setting, the CDI scale is set to 5 nm during the enroute/oceanic phase of flight. Within 30 nm of the destination airport the CDI scale gradually ramps down to 1.0 nm (terminal area). Likewise when leaving the departure airport the CDI scale is set to 1.0 nm and gradually ramps UP to 5 nm beyond 30 nm (from the departure airport).

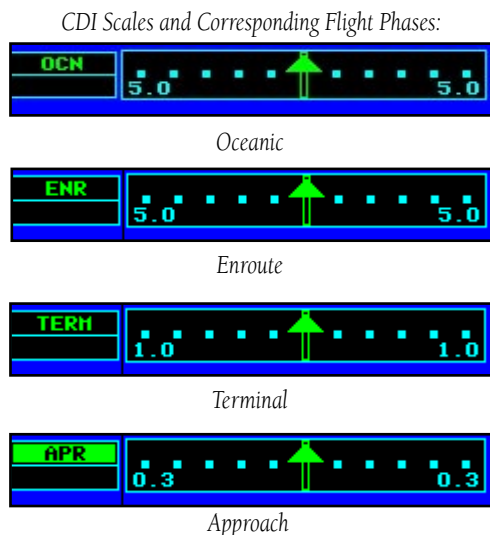

**Figure 10-54** CDI Scales

During approach operations the CDI scale gradually ramps down even further, to 0.3 nm. This transition normally occurs within 2.0 nm of the final approach fix (FAF). If a lower CDI scale setting is selected (i.e., 1.0 nm or 0.3 nm) the higher scale settings are not selected during any phase of flight. For example, if 1.0 nm is selected, the GNS 430 uses this for the enroute and terminal phase and ramp down to 0.3 nm during an approach. Note that the Receiver Autonomous Integrity Monitoring (RAIM) protection limits listed in Table 10-2 follow the selected CDI scale and corresponding modes:

| CDI Scale/Flight Phase:    | RAIM Protection: |
|----------------------------|------------------|
| Auto (oceanic)             | 4.0 nm           |
| ±5.0 nm or Auto (enroute)  | 2.0 nm           |
| ±1.0 nm or Auto (terminal) | 1.0 nm           |
| ±0.3 nm or Auto (approach) | 0.3 nm           |

**Table 10-2** CDI Scales

An ‘auto’ ILS CDI selection allows the GNS 430 to automatically switch the external CDI from the GPS receiver to the VLOC receiver, when established on the final approach course (Section 6.3). Or, select ‘manual’ to manually switch the external CDI connection, as needed.

An arrival alarm, provided on the CDI/Alarms Page, may be set to notify the pilot with a message when a user-defined distance to the final destination (the direct-to waypoint or the last waypoint in a flight plan) has been reached. Once the aircraft has reached the set distance (up to 99.9 units), an ‘Arrival at [waypoint]’ message is displayed.

- ‘Units/Mag Var’ - Allows the pilot to configure the displayed data to standard or metric units of measure. This setting applies to distance, speed, altitude, fuel, pressure, and temperature. Also provides three magnetic variation (heading) options: True, Auto, or User-defined. If ‘Auto’ is selected, all track, course and heading information is corrected to the magnetic variation computed by the GPS receiver. The ‘True’ setting references all information to true north, and the ‘User’ setting corrects information to an user-entered value.

- ‘Position/Map Datum’ - Configures position readout information to the desired position format and datum. The NavData card contains over 100 map datums to adjust the position reading, making it conform to specific paper charts. If using a chart based on another datum, the pilot must set the GNS 430 to use the same datum. Using a map datum that does not match the charts used by the pilot can result in significant differences in position information. If the pilot is using the paper charts for reference only, the GNS 430 still provides correct navigation guidance to the waypoints contained in the database, regardless of the datum selected.
- ‘Date/Time’ - Provides settings for time format (local or UTC; 12- or 24-hour) and time offset. The time offset is used to define current local time. UTC (also called ‘GMT’ or ‘zulu’) date and time are calculated directly from the GPS satellites’ signals and cannot be changed. To use local time, simply designate the offset by adding or subtracting the correct number of hours.

## Setup 1 Page: Airspace Alarms

**To set the airspace warning messages or change the altitude buffer:**

- 1) Select ‘Airspace Alarms’ from the Setup 1 Page (Figure 10-55), using the steps described at the beginning of this section.



Figure 10-55 Airspace Alarms Highlighted

- 2) Turn the large **right** knob to highlight the ‘On’/‘Off’ field next to the desired airspace type. (‘Other SUAs’ includes alert, caution, danger, training, and warning areas.)
- 3) Turn the small **right** knob to select ‘On’ or ‘Off’, as desired (Figure 10-56). Press the **ENT** Key to accept the selection.



Figure 10-56 TWR/CTL Zone Alarm Window

- 4) To change the altitude buffer, turn the large **right** knob to highlight the ‘Altitude Buffers’ field (Figure 10-57). Use the small and large **right** knobs to enter the desired buffer distance. Press the **ENT** Key when finished.

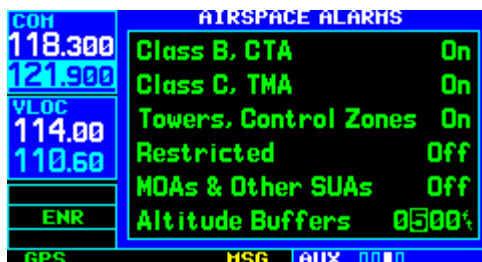

Figure 10-57 Buffer Distance Field Selected



*NOTE: When an approach has been loaded into the active flight plan, airspace alert messages are disabled within 30nm of the destination airport.*

## Setup 1 Page: CDI Scale/Alarms

### To change the CDI scale:

- 1) Select 'CDI/Alarms' from the Setup 1 Page (Figure 10-58), using the steps described at the beginning of this section.



Figure 10-58 CDI/Alarms Highlighted

- 2) The flashing cursor highlights the 'Selected CDI' field. Turn the small **right** knob to select the desired CDI scale. The selected scale and any lower scale settings are used during the various phases of flight as described at the beginning of this section.

- 3) Press the **ENT** Key to accept the selected scale. The 'System CDI' field displays the CDI scale currently in use (Figure 10-59). The 'System CDI' setting may differ from the 'Selected CDI' depending upon the current phase of flight.



Figure 10-59 Selected CDI Field Highlighted

### To change the ILS CDI selection:

- 1) Select 'CDI/Alarms' from the Setup 1 Page, using the steps described at the beginning of this section.
- 2) Turn the large **right** knob to highlight the 'Auto'/'Manual' ILS CDI field.
- 3) Turn the small **right** knob to select 'Auto' or 'Manual', as desired (Figure 10-60). Press the **ENT** Key to accept the selection.



Figure 10-60 ILS CDI Window

**To set the arrival alarm and alarm distance:**

- 1) Select 'CDI/Alarms' from the Setup 1 Page, using the steps described at the beginning of this section.
- 2) Turn the large **right** knob to highlight the 'On'/'Off' field (directly below 'Arrival Alarm').
- 3) Turn the small **right** knob to select 'On' or 'Off', as desired. Press the **ENT** Key to accept the selection.
- 4) The flashing cursor moves to the alarm distance field (to the immediate right of 'On' or 'Off'). To enter an arrival alarm distance, use the small and large **right** knobs to enter the desired alarm distance. Press the **ENT** Key when finished.



*NOTE: The CDI scale is always measured in nautical miles, regardless of the current distance units of measure selected on the Units/Mag Var Page.*

**Setup 1 Page: Units/Mag Var**

**To set the magnetic variation:**

- 1) Select 'Units/Mag Var' from the Setup 1 Page (Figure 10-61), using the steps described at the beginning of this section.

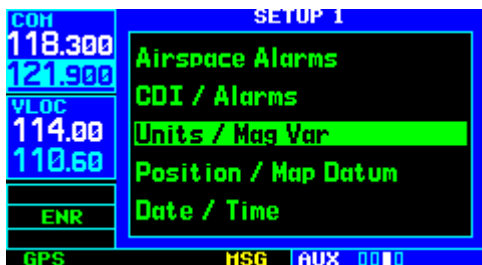

Figure 10-61 Units/Mag Var Highlighted

- 2) The flashing cursor highlights the heading mode field. Turn the small **right** knob to select the desired heading mode: Auto, True, or User (Figure 10-62). Press the **ENT** Key to accept the selection. (The heading modes are described at the beginning of this section.)



Figure 10-62 Heading Mode Window

- 3) If 'User' is selected, the flashing cursor moves to the user value field (to the immediate right of 'User'). Use the small and large **right** knobs to enter the desired magnetic variation direction and value. Press the **ENT** Key when finished.

**To change the units of measure:**

- 1) Select 'Units/Mag Var' from the Setup 1 Page, using the steps described at the beginning of this section.
- 2) Turn the large **right** knob to highlight the desired units of measure category (Figure 10-63). The following categories, and corresponding units of measure, are available:



Figure 10-63 Units Mag/Var Page

- DIS, SPD - Distance and speed in Nautical (nautical miles/knots), Statute (miles/miles per hour), or Metric (kilometers/kilometers per hour) terms.
  - ALT, VS - Altitude and vertical speed in Feet/feet per minute, Meters/meters per minute, or Meters/meters per second.
  - PRESSURE - Barometric pressure in Inches or Millibars.
  - TEMP - Temperature in degrees Celsius or Fahrenheit.
  - FUEL - Fuel units in Gallons, Imperial Gallons, Kilograms, Liters, or Pounds.
- 3) Turn the small **right** knob to select the desired units of measure for the selected category. Press the **ENT** Key to accept the selection.

### Setup 1 Page: Position Format/Map Datum

#### To change the position format:

- 1) Select 'Position Format/Map Datum' from the Setup 1 Page (Figure 10-64), using the steps described at the beginning of this section.
- 2) The flashing cursor is on the position format field (Figure 10-65). Turn the small **right** knob to select the desired position format.
- 3) Press the **ENT** Key to accept the selected format.



Figure 10-64 Position/Map Datum Highlighted



Figure 10-65 Position Format Window

The following position formats are available:

- hddd°mm.mmm' - Latitude and longitude in degrees and decimal minutes
  - hddd°mm'ss.s' - Latitude and longitude in degrees, minutes, and decimal seconds
  - MGRS - Military Grid Reference System
  - UTM/UPS - Universal Transverse Mercator/ Universal Polar Stereographic grids
- 3) Press the **ENT** Key to accept the selected format.

**To change the map datum:**

- 1) Select 'Position Format/Map Datum' from the Setup 1 Page, using the steps described at the beginning of this section.
- 2) Turn the large **right** knob to highlight the map datum field (Figure 10-66).



Figure 10-66 Map Datum Field Highlighted

- 3) Turn the small **right** knob to display a window showing the available map datums.
- 4) Continue turning the small **right** knob to select the desired map datum. (Appendix C for a list of available map datums.)
- 5) Press the **ENT** Key to accept the selected datum.



*NOTE: Per TSO C129a, the WGS-84 map datum should be used in the United States. For use outside the U.S., select the geodetic datum required by that country. See complete listing of map datums in Appendix C.*

**Setup 1 Page: Date/Time**

**To display local time or UTC:**

- 1) Select 'Date/Time' from the Setup 1 Page, using the steps described at the beginning of this section.

- 2) The flashing cursor highlights the time format field (Figure 10-67). Turn the small **right** knob to display a window of available time formats: Local 12hr, Local 24hr, or UTC.

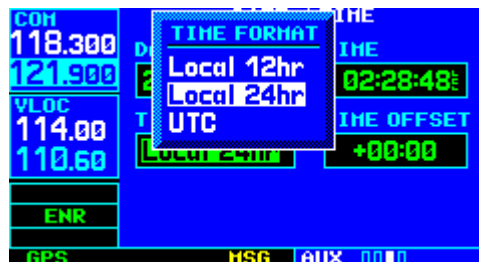

Figure 10-67 Time Format Window

- 3) Continue turning the small **right** knob to select the desired time format.
- 4) Press the **ENT** Key to accept the selection.

**To set the local time:**

- 1) Select 'Date/Time' from the Setup 1 Page, using the steps described at the beginning of this section.
- 2) Turn the large **right** knob to highlight the time offset field (Figure 10-68).



Figure 10-68 Time Offset Field Highlighted



- 3) Use the small and large **right** knobs to enter the desired offset, beginning by entering a minus (-) or plus (+) sign to indicate whether the offset is behind UTC or ahead of UTC. (In the United States, all local time offsets use minus, or behind UTC.)
- 4) Press the **ENT** Key to accept the selected offset.

### Restoring Factory Settings

When making changes to any Setup 1 Page option, a 'Restore Defaults?' menu selection allows the pilot to restore the original factory settings (for the selected option only). For example, with the Airspace Alarms Page displayed, the 'Restore Defaults?' option restores all Airspace Alarms Page settings to the original factory values.

#### To restore a Setup 1 option to the original factory settings:

- 1) Select the desired menu option from the Setup 1 Page, using the steps described at the beginning of this section.
- 2) Press the **MENU** Key to display the Date/Time Page Menu (Figure 10-69).



Figure 10-69 Date/Time Page Menu

- 3) With 'Restore Defaults?' highlighted, press the **ENT** Key.

### 10.5 SETUP 2 PAGE

The Setup 2 Page (Figure 10-70) provides access (via 'menu options') to display adjustments, parameters which define the nearest airport search, and COM transceiver channel spacing. When a menu option is selected, the corresponding page appears providing access to the various unit settings.

#### To select a menu option from the Setup 2 Page:

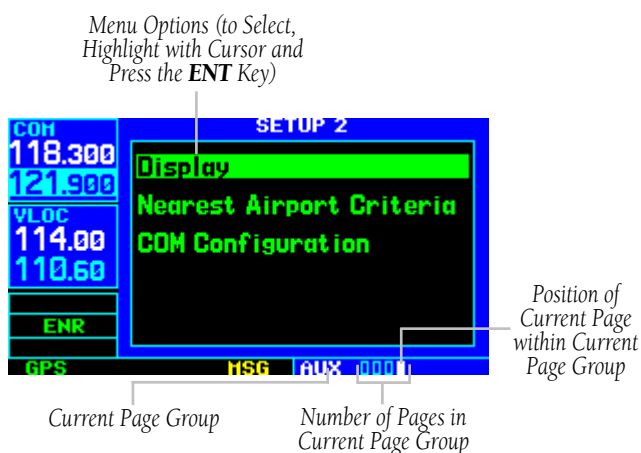

Figure 10-70 Setup 2 Page

- 1) Press the small **right** knob momentarily, to activate the flashing cursor (Figure 10-70).

- 2) Turn the large **right** knob to select the desired menu option (Figure 10-71), and press the **ENT** Key (Figure 10-72).



**Figure 10-71 Nearest Airport Criteria Highlighted**

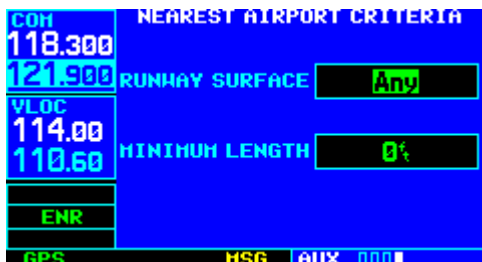

**Figure 10-72 Nearest Airport Criteria Page**

The following menu options are available:

- ‘Display’ - Allows the pilot to adjust the display for optimum viewing in any condition. Automatic backlighting is available which uses a built-in photocell (at the top left corner of the display bezel) to make the proper display adjustments without any user intervention. Automatic contrast adjustment varies the screen contrast level based upon current unit temperature. The pilot may also select manual control of the display contrast and backlighting of the GNS 430’s display.

- ‘Nearest Airport Criteria’ - Defines the minimum runway length and surface type used when determining the nine nearest airports to display on the Nearest Airport Page. A minimum runway length and/or surface type may be entered to prevent airports with small runways, or runways that are not of appropriate surface, from being displayed. The default settings are ‘0 feet (or meters)’ for runway length and ‘any’ for runway surface type.
- ‘COM Configuration’ - Allows selection of 8.33 kHz or 25.0 kHz COM frequency channel spacing.



*NOTE: 8.33 kHz VHF communication frequency channel spacing is not approved for use in the United States.*

## Setup 2 Page: Display

### To change the backlighting intensity:

- 1) Select ‘Display’ from the Setup 2 Page (Figure 10-73), using the steps described at the beginning of this section (10.5).



**Figure 10-73 Display Highlighted**

- 2) The flashing cursor highlights the backlight mode field. Turn the small **right** knob to select the desired mode: Auto or Manual (Figure 10-74). Press the **ENT** Key to accept the selection.



Figure 10-74 Backlight Mode Window

- 3) If 'Manual' is selected, the flashing cursor moves to the backlight level field. Turn the small **right** knob to select the desired level. Press the **ENT** Key to accept the selection.

#### To change the display contrast:

- 1) Select 'Display' from the Setup 2 Page, using the steps described at the beginning of this section.
- 2) Turn the large **right** knob to highlight the contrast mode field (Figure 10-75).



Figure 10-75 Contrast Mode Field Highlighted

- 3) Turn the small **right** knob to select the desired mode: Auto or Manual. Press the **ENT** Key to accept the selection.
- 4) If 'Manual' is selected, the flashing cursor moves to the contrast level field. Turn the small **right** knob to select the desired level. Press the **ENT** Key to accept the selection.

## Setup 2 Page: Nearest Airport Criteria

### To set the minimum runway length and runway surface:

- 1) Select 'Nearest Airport Criteria' from the Setup 2 Page, using the steps described at the beginning of this section.
- 2) The flashing cursor highlights the runway surface field (Figure 10-76). Turn the small **right** knob to select the desired surface. The following options are available:
  - Any surface
  - Hard surfaces only
  - Hard or Soft surfaces
  - Water landings only



Figure 10-76 Surface Type Window

- 3) Press the **ENT** Key to accept the runway surface selection.

- The flashing cursor moves to the minimum runway length field (Figure 10-77). To enter a different minimum runway length, use the small and large **right** knobs to enter the desired length. Press the **ENT** Key when finished.



Figure 10-77 Minimum Runway Length Field Selected

### Setup 2 Page: COM Configuration

To set the COM channel spacing:

- Select 'COM Configuration' from the Setup 2 Page, using the steps described at the beginning of this section.
- The flashing cursor highlights the channel spacing field (Figure 10-78). Turn the small **right** knob to select the desired channel spacing: 8.33 kHz or 25.0 kHz. Press the **ENT** Key when finished.



Figure 10-78 Channel Spacing Window

### Restoring Factory Settings

When making changes to any Setup 2 Page option, a 'Restore Defaults?' menu selection restores the original factory settings (for the selected option).

To restore a Setup 2 option to the original factory settings:

- Select the desired menu option from the Setup 2 Page, using the steps described at the beginning of this section.
- Press the **MENU** Key to display the COM Setup Page Menu (Figure 10-79).

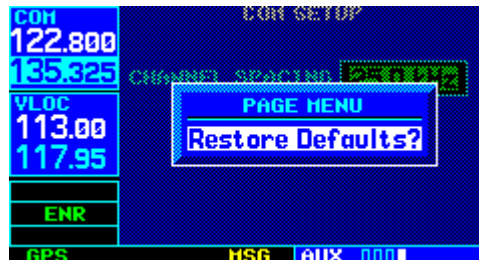

Figure 10-79 COM Setup Page Menu

- With 'Restore Defaults?' highlighted, press the **ENT** Key.

## SECTION 11: TERRAIN INTERFACE

### 11.1 INTRODUCTION

#### Overview

Garmin TERRAIN is a non-TSO-C151b-certified terrain awareness system incorporated into GNS 430 units to increase situational awareness, and aid in reducing controlled flight into terrain (CFIT). TERRAIN functionality is a standard feature found in GNS 430 units with main software version 5.01 or above, along with appropriate hardware upgrades.



---

**NOTE:** *Not all GNS 430 units are equipped with or configured for TERRAIN. See the 400 Series Installation Manual (190-00140-02) for TERRAIN configuration information.*

---

#### Operating Criteria

The Garmin TERRAIN system requires the following to operate properly:

- The system must have a valid 3D GPS position solution
- The system must have valid terrain and obstacle databases

#### Advisory Only

The TERRAIN function displays altitudes of terrain and obstructions relative to the aircraft's altitude and are advisory in nature only. Individual obstructions may be shown if available in the database. Not all obstructions may be available in the database and data may be inaccurate—do not maneuver or navigate to avoid obstacles using this information. Terrain information is based on terrain elevation data contained in a database, which may contain inaccuracies. Terrain information should be used as an aid to visual acquisition—do not use terrain information to navigate or maneuver to avoid terrain.

## 11.2 TERRAIN OPERATION

### Power Up

During power-up of the GNS 430 unit, the terrain and obstacle database versions are displayed along with a disclaimer (Figure 11-1). At the same time, the TERRAIN system self-test begins. A failure message is issued if the test fails (Section 11.3).



Figure 11-1 Terrain Database Page

### TERRAIN Page

See Section 3.5 for a complete description of the TERRAIN Page and its operation.

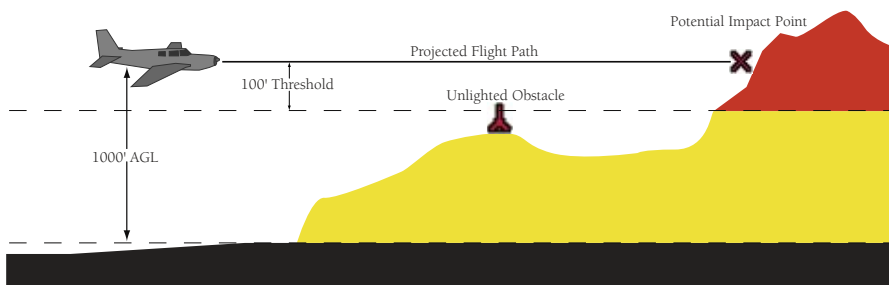

Figure 11-2 TERRAIN Altitude/Color Correlation

### Color Interpretation

The Garmin TERRAIN system uses black, yellow, and red to depict terrain information relative to aircraft altitude (Figure 11-2 and Table 11-1).

| Color  | Terrain/Obstacle Location   |
|--------|---|
| Red    | Terrain/Obstacle is within 100 feet above or below aircraft altitude.           |
| Yellow | Terrain/Obstacle is between 1000 feet and 100 feet below the aircraft altitude. |
| Black  | Terrain/Obstacle is more than 1000 feet below aircraft altitude.                |

Table 11-1 TERRAIN Color Symbology

## General Database Information

The Garmin TERRAIN system uses terrain and obstacle information supplied by government sources. The data undergoes verification by Garmin to confirm accuracy of the content. However, the information displayed should never be understood to be all-inclusive. Pilots must familiarize themselves with the appropriate sectional charts for safe flight.



**NOTE:** *The data contained in the terrain and obstacle databases comes from government agencies. Garmin accurately processes and cross-validates the data, but cannot guarantee the accuracy and completeness of the data.*

The terrain and obstacle databases are contained on a datacard which is inserted in the right-hand slot of the GNS 430 unit, see Appendix A for more information.

## Database Versions

The version and area of coverage of each terrain and obstacle database is shown on the Terrain Database Versions Page, located in the AUX Page Group (Figure 11-3). Databases are checked for integrity at power-up. If a database is found to be missing and/or deficient, the TERRAIN system fails the self-test and issues a failure message (Section 11.3).



Figure 11-3 Terrain Database Versions Page

## Database Updates

Terrain and obstacle databases are updated periodically with the latest terrain and obstacle data. Visit the Garmin website to check for newer versions of terrain and obstacle databases (compare database cycle numbers to determine if a newer version is available). Updated terrain data cards may be obtained by calling Garmin at one of the numbers listed in the front of this document.

### To update the terrain or obstacle database:

- 1) Acquire a new terrain data card from Garmin, or download the terrain and obstacle database from the Garmin website ([www.garmin.com](http://www.garmin.com)).
- 2) Turn off the power to the GNS 430.
- 3) Remove the old terrain data card from and insert the new card into the right-most slot of the GNS 430.
- 4) Turn on the GNS 430 and verify that the TERRAIN system passes the self-test.

**Terrain and obstacle Database Areas of Coverage**

The following describes the area of coverage available in each database. Regional definitions may change without notice.

**Worldwide (WW):**

Latitudes: S60 to N75  
Longitudes: W180 to E180

**Americas (AME):**

Latitudes: S60 to N75  
Longitudes: W180 to W30

**Atlantic (ATL):**

Latitudes: S60 to N75  
Longitudes: W30 to E90

**Pacific (PAC):**

Latitudes: S60 to N75  
Longitudes: E60 to E180

**United States (US):**

Limited to the United States plus some areas of Canada, Mexico, Caribbean, and the Pacific.



---

**CAUTION:** *Obstacles 200 feet and higher are included in the Obstacle Database. It is very important to note that not all obstacles are necessarily charted and therefore may not be contained in the Obstacle Database.*

---

**Navigation Database**

As explained in the ‘Premature Descent Alerting (PDA)’ section (Section 11.3), the Garmin TERRAIN premature descent alerting (PDA) algorithms utilize data contained in the Navigation Database. It is therefore important to also have the latest Navigation Database installed to ensure correct TERRAIN alerting.

**TERRAIN Phase of Flight**

The TERRAIN Phase of Flight definitions are listed below.

- Enroute Phase - Defined as when the aircraft is more than 15 nm from the destination airport, or when the conditions for Terminal, Approach, and Departure Phases are not met.
- Terminal Phase - Defined as when all three of the following conditions are met:
  - 1) The aircraft is 15 nm or less from the destination runway.
  - 2) The distance to the destination runway threshold is decreasing.
  - 3) The aircraft is at or below (lower than) a straight line drawn between the two points specified in Table 11-2 (relative to the destination runway).

| Distance-to-Runway | Height-above-Runway |
|--------------------|---------------------|
| 15 nm              | 3500 Feet           |
| 5 nm               | 1900 Feet           |

**Table 11-2 Terminal Phase Distance-to-Runway Versus Height-Above-Runway**



- Approach Phase – Defined as when all three of the following conditions are met:
  - 1) The distance to destination runway threshold is equal to or less than 5 nm.
  - 2) The height above the destination runway threshold elevation is equal to or less than 1900 feet.
  - 3) The distance to the destination runway threshold is decreasing.
- Departure Phase – Defined as when all five of the following conditions are met:
  - 1) It has been determined that the aircraft was previously ‘on-ground’.
  - 2) The aircraft has a vertical velocity greater than zero.
  - 3) The aircraft has a groundspeed greater than 35 knots.
  - 4) The aircraft has an altitude greater than 150 feet AGL and less than 1500 feet AGL.
  - 5) The aircraft is within 15 nm of the departure airport.



**NOTE:** *There are additional factors beyond those outlined in the preceding paragraphs that may alter the determined TERRAIN flight phase.*

## Nearest Airport Criteria and Terrain Phase of Flight

Changes to the Nearest Airport Criteria Page (Figure 11-4) affect how the TERRAIN system performs. The Nearest Airport List is used to derive the terrain destination airport when there is no loaded active flight plan or when deviating from the active flight plan (when the terrain algorithms go into estimation mode). In turn, the Nearest Airport List is used to determine the terrain phase of flight. The terrain phase of flight dictates the Required Terrain Clearance (RTC) levels at which Forward Looking Terrain Avoidance (FLTA) alerting occurs, as described in Section 11.3. PDA alerting is also affected as described in Section 11.3.



Figure 11-4 Nearest Airport Criteria Page

As an example, if the pilot configures the unit to include only airports with runways 5000 feet or longer, only these are added to the Nearest Airport List. The terrain phase of flight is affected in that all airport runways under 5000 feet are not included in terrain calculations. During a cross-country flight with this configuration, only airports runways 5000 feet or greater cause the unit to go into Terminal or Approach Mode from Enroute mode. If the pilot makes an emergency landing at an airport that did not show up in the Nearest Airport List, FLTA alerts would be issued throughout the descent.

## **TERRAIN Destination Airport**

The TERRAIN destination airport is considered to be the next airport in the flight plan while adhering to the flight plan path. If no flight plan is entered, or if the aircraft is not adhering to the entered flight plan path, the terrain destination airport is estimated using the Nearest Airport Criteria as described in the section above.

## **GPS Position and GPS-MSL Altitude**

Garmin TERRAIN uses information provided by the GNS 430 GPS receiver to provide a horizontal position and altitude. GPS altitude is derived from satellite measurements. GPS altitude is converted to a Mean Sea Level (MSL)-based altitude (GPS-MSL Altitude) and is used to determine terrain alerts. GPS-MSL altitude accuracy is affected by factors such as satellite geometry, but is not subject to variations in pressure and temperature that normally affect pressure altitude devices. GPS-MSL altitude does not require local altimeter settings to determine MSL Altitude. Therefore, GPS altitude provides a highly accurate and reliable MSL altitude source to calculate terrain and obstacle alerts.

## **TERRAIN Alerting using the GPS Position/GPS-MSL Altitude**

The Garmin TERRAIN system utilizes terrain and obstacle databases that are referenced to Mean Sea Level (MSL). Using the GPS Position and GPS-MSL Altitude, Garmin TERRAIN portrays a 2D picture of the surrounding terrain and obstacles relative to the position and altitude of the aircraft. Furthermore, the GPS Position and GPS-MSL Altitude are used to calculate and ‘predict’ the aircraft’s flight path in relation to the surrounding terrain and obstacles. In this manner, the Garmin TERRAIN system can provide advanced alerts of predicted dangerous terrain conditions. Detailed alert information is given in Section 11.3.

## **Baro-Corrected Altitude versus GPS-MSL Altitude**

Baro-Corrected Altitude (or Indicated Altitude) is derived by adjusting the altimeter setting for the local atmospheric conditions. The most accurate Baro-Corrected Altitude can be achieved by frequently updating the altimeter setting to the nearest reporting station along the flight path. However, because actual atmosphere conditions seldom match the standard conditions defined by the International Standard Atmosphere model (where pressure, temperature, and lapse rates have fixed values), it is common for the Baro-Corrected Altitude (as read from the altimeter) to differ from the GPS-MSL Altitude. This variation results in the aircraft’s True Altitude differing from the Baro-Corrected Altitude.

### 11.3 TERRAIN ALERTS

TERRAIN alerts are issued when flight conditions meet parameters that are set within the TERRAIN system software algorithms. When an alert is issued, visual annunciations are displayed. Annunciations appear in a dedicated field in the lower left corner of the display (Figure 11-5).

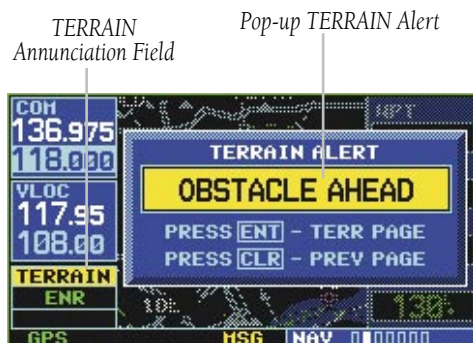

**Figure 11-5 TERRAIN Annunciation and Pop-up Alerts**

#### Pop-up Alerts

On any page except the TERRAIN Page, when a terrain or obstacle alert is issued, a pop-up window is displayed with the appropriate alert (Figure 11-5).

**To acknowledge the pop-up alert and return to the currently viewed page:**

Press the **CLR** Key.

**To acknowledge the pop-up alert and quickly display the TERRAIN Page:**

Press the **ENT** Key.

#### Forward Looking Terrain Avoidance

The Forward Looking Terrain Avoidance alert, or FLTA, is used by the TERRAIN system and is composed of two elements:

- **Reduced Required Terrain Clearance (RTC) Avoidance** - Provides alerts when the aircraft flight path is above terrain, yet is projected to come within minimum clearance values outlined in Table 11-3. When an RTC alert is issued, a potential impact point (Section 3.5) is displayed on the TERRAIN Page.
- **Imminent Terrain Impact (ITI) Avoidance** - Provides alerts when the aircraft is below the elevation of a terrain cell in the aircraft's projected path. ITI alerts are accompanied by a potential impact point displayed on the TERRAIN Page. The alert is given when the projected vertical flight path is calculated to come within minimum clearance altitudes in the Table 11-3.

| TERRAIN Phase of Flight | Level Flight | Descending |
|-------------------------|--------------|------------|
| Enroute                 | 700 feet     | 500 feet   |
| Terminal                | 350 feet     | 300 feet   |
| Approach                | 150 feet     | 100 feet   |
| Departure               | 100 feet     | 100 feet   |

**Table 11-3 Minimum Terrain and Obstacle Clearance Values for FLTA Alerts**



**NOTE:** See the *TERRAIN Phase of Flight definition* in Section 11.2.

During the final approach phase of flight, RTC/ITI alerts are automatically inhibited when the aircraft is below 200 feet AGL while within 0.5 nm of the approach runway or is below 125 feet AGL while within 1 nm of the threshold.

**FLTA Alerts**

- ‘TERRAIN ADVISORY’ advisory - Estimated potential impact in approximately 60 seconds after pop-up alert and annunciation (Figure 11-6). Similarly, an ‘OBSTACLE ADVISORY’ alert is also provided.



Figure 11-6 ‘TERRAIN ADVISORY’ Advisory

- ‘TERRAIN AHEAD’ alert (flashing) - Estimated potential impact in approximately 30 seconds after pop-up alert and annunciation (Figure 11-7). Similarly, an ‘OBSTACLE AHEAD’ alert is also provided.

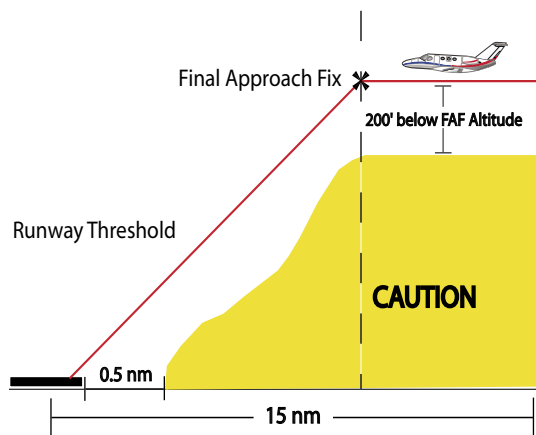

Figure 11-7 ‘TERRAIN AHEAD’ Alert (flashing)

**Premature Descent Alerting (PDA)**

The TERRAIN system issues a Premature Descent alert when the system detects that the aircraft is significantly below the normal approach path to a runway. There are three different scenarios to consider with PDA:

- No Approach Loaded - PDA alerting begins when the aircraft is within 15 nm of the destination airport and ends when the aircraft is either 0.5 nm from the runway threshold OR is at an altitude of 125 feet AGL while within 1 nm of the threshold. During the final descent, algorithms set a threshold for alerting based on altitude, distance, and other parameters.



**Figure 11-8 Non-Precision Approach PDA Alert Threshold**

- ILS Approach Loaded - PDA alerting begins when the aircraft is within 15 nm of the destination airport and the aircraft is on the flight plan path. Prior to crossing the FAF, the pilot receives a PDA alert if the aircraft descends more than 200 feet below the FAF crossing altitude. Once the aircraft crosses the FAF and is inbound to the runway, PDA alerts the pilot if the aircraft descends  $0.7^\circ$  below the ILS glideslope (Figure 11-9). PDA alerting ends 0.5 nm from the runway threshold OR at an altitude of 125 feet AGL while within 1 nm of the threshold.

- Non-Precision Approach Loaded - PDA alerting begins when the aircraft is within 15 nm of the destination airport and the aircraft is on the flight plan path. The threshold for the descent is computed by algorithms based on varying flight conditions (Figure 11-8). PDA alerting ends at 0.5 nm from the runway threshold OR at an altitude of 125 feet AGL while within 1 nm of the threshold.

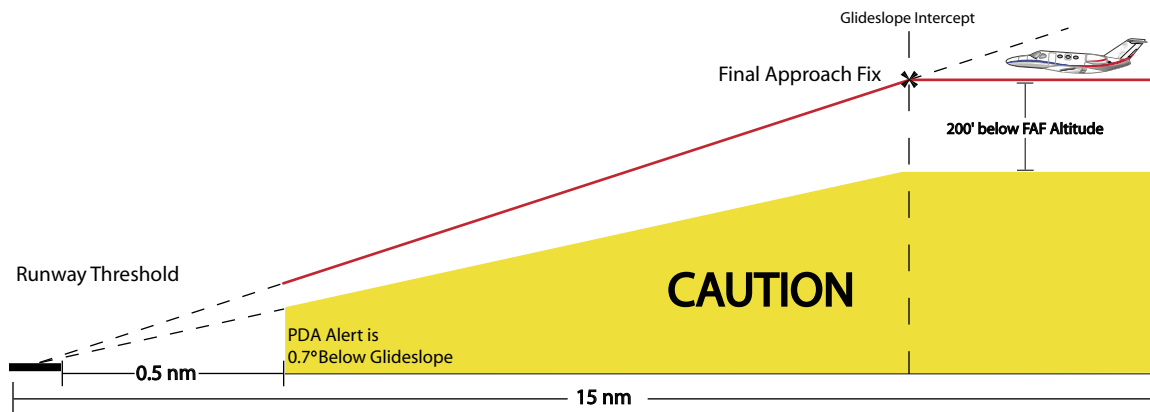

**Figure 11-9 ILS Approach PDA Alert Threshold**

**PDA Alert**

- CAUTION - The annunciation and pop-up terrain alert shown in Figure 11-10 are displayed during a PDA alert.



**Figure 11-10 PDA Alert**

**Premature Descent Alerting (PDA) using GPS-MSL Altitude**

The Premature Descent Alert (PDA) is annunciated when the aircraft is below the recommended minimum altitude for an approach (Section 11.3, Premature Descent Alerting (PDA) for details). The aircraft’s GPS-MSL altitude is compared to a calculated Above-Ground-Level (AGL) altitude along the estimated path to the airport. When the aircraft descends below the calculated minimum altitude for the estimated path, the PDA alert is annunciated. PDA alerting is provided for both non-published visual approaches and published instrument approaches to airports.

When an instrument approach is loaded in the active flight plan, the PDA function can provide a greater margin of safety by alerting for altitude deviations below minimum approach altitudes. Minimum altitudes are typically known for the segment prior to the final approach fix and for step-down fixes prior to the missed approach point. Minimum descent altitudes, decision altitudes, and decision heights are not known for instrument approaches. These minimum altitudes, as shown on instrument approach procedures, are published as MSL altitudes and flown by reference to barometric altitude provided on the altimeter. Non-standard atmospheric conditions, as described in the previous section, may result in differences between GPS-MSL altitude and Baro-Corrected altitude. These differences may reach a level that can trigger a PDA when flying the published minimum altitude as indicated on the altimeter. Operations in below-standard-temperature environments may require the pilot to compensate for the non-standard temperature by increasing the minimum altitude that is defined in the approach procedure for standard atmospheric conditions.

Differences between GPS-MSL altitude and Baro-Corrected altitude typically increase as height above ground level increases due to non-standard atmospheric effects. In response to PDAs, the pilot should always ascertain the appropriate altitude is being flown in consideration of atmospheric conditions.

## TERRAIN Failure Alert

The TERRAIN system continually monitors several system-critical items, such as database validity, hardware status, and GPS status. Should the system detect a failure, a message is annunciated 'TERRAIN has failed' (Figure 11-11).



Figure 11-11 'TERRAIN has failed' Message

## 'TERRAIN Not Available' Alert

The TERRAIN system requires a 3D GPS navigation solution along with specific vertical accuracy minimums. Should the navigation solution become degraded, if the terrain and obstacle database is not available, or if the aircraft is out of the database coverage area, the annunciation 'TERRAIN NOT AVAILABLE' is displayed on the TERRAIN Page (Figure 11-12).



Figure 11-12 'TERRAIN NOT AVAILABLE' Annunciation

**TERRAIN Alert Summary**

Table 11-4 summarizes the TERRAIN alerts.

| Alert Type                                 | Annuciation                  | Pop-Up Alert                        |
|--|------------------------------|-------------------------------------|
| TERRAIN Failure                            | <b>TER FAIL</b>              | None                                |
| TERRAIN Inhibited                          | <b>TER INHB</b>              | None                                |
| TERRAIN Not Available                      | <b>TER N/A</b>               | None                                |
| Required Terrain Clearance (RTC) Advisory  | <b>TERRAIN</b>               | <b>TERRAIN ADVISORY</b>             |
| Required Terrain Clearance (RTC) Alert     | <b>TERRAIN</b><br>(FLASHING) | <b>TERRAIN AHEAD</b><br>(FLASHING)  |
| Imminent Terrain Impact (ITI) Advisory     | <b>TERRAIN</b>               | <b>TERRAIN ADVISORY</b>             |
| Imminent Terrain Impact (ITI) Alert        | <b>TERRAIN</b><br>(FLASHING) | <b>TERRAIN AHEAD</b><br>(FLASHING)  |
| Required Obstacle Clearance (ROC) Advisory | <b>TERRAIN</b>               | <b>OBSTACLE ADVISORY</b>            |
| Required Obstacle Clearance (ROC) Alert    | <b>TERRAIN</b><br>(FLASHING) | <b>OBSTACLE AHEAD</b><br>(FLASHING) |
| Imminent Obstacle Impact (IOI) Advisory    | <b>TERRAIN</b>               | <b>OBSTACLE ADVISORY</b>            |
| Imminent Obstacle Impact (IOI) Alert       | <b>TERRAIN</b><br>(FLASHING) | <b>OBSTACLE AHEAD</b><br>(FLASHING) |
| Premature Descent Alert (PDA)              | <b>TERRAIN</b>               | <b>TOO LOW - TERRAIN</b>            |

**Table 11-4 TERRAIN Alerts Summary**



## SECTION 12: FAULT DETECTION AND EXCLUSION

FDE is an acronym that stands for Fault Detection and Exclusion. FDE was incorporated in the Garmin GNS 430 Main and GPS Software version 3.00 and higher. FDE algorithms, provide a basis for approval per the requirements for 'GPS as a Primary Means of Navigation for Oceanic/Remote Operations' per FAA Notice N8110.60. The oceanic flight phase is used by the GNS 430 when the aircraft is more than 200 nm from the nearest airport. FDE requires no pilot interaction during flight, but predicting the capability of the GPS constellation to provide service during a flight is done by the pilot prior to departure.

### 12.1 DETECTION AND EXCLUSION

FDE consists of two distinct parts, fault detection and fault exclusion. The detection function refers to the capability to detect a satellite failure which can affect navigation. Upon detection, the exclusion function excludes one or more failed satellites and prevent them from being used during navigation. This allows the GPS to return to normal performance without interruption. The process is entirely automated and does not require pilot interaction during flight. On the Satellite Status Page, the pilot can view information related to FDE operation. To enhance safety, FDE functionality is provided for other phases of flight (non-precision approach, terminal, enroute). The FDE functionality for non-oceanic flight phases adheres to the same missed alert probability, false alert probability, and failed exclusion probability specified by N8110.60.

Figure 12-1 shows satellite number 9 exclusion during oceanic phase of flight. No message notifying the user of exclusion appears. In addition to the EPE and DOP fields, there is the Horizontal Uncertainty Level (HUL) field which displays a 99% confidence level that the aircraft position is within a circle with a radius of the value displayed in the HUL field.

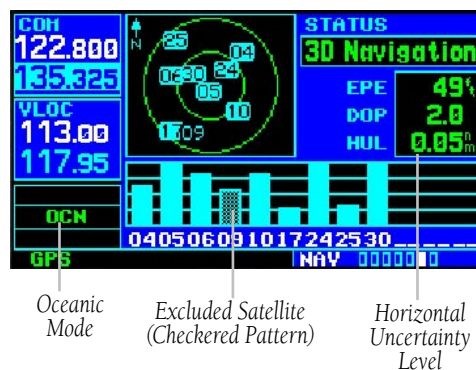

Figure 12-1 Satellite Status Page

## 12.2 PRE-DEPARTURE VERIFICATION OF FDE

Since FDE is based upon the exclusion of ‘bad’ satellites, it is necessary to ensure there will be an adequate number of satellites in the GPS constellation that are still able to provide a navigation solution. An FDE prediction must be performed prior to departure for a flight involving:

- Oceanic/Remote operation where GPS is to be the sole source of navigation per FAA Notice 8110.60
- U.S. Area Navigation (RNAV) routes, Standard Instrument Departures (SIDs), or Standard Terminal Arrival Routes (STARs) if a NOTAM indicates a GPS satellite (or satellites) is scheduled to be out-of-service, per FAA AC 90-100 ‘U.S. Terminal and En Route Area Navigation (RNAV) Operations’

Prior to departure, the operator must use the FDE Prediction Program supplied with the 400 Series Trainer Software (Figure 12-2) to demonstrate that there are no outages in the capability to navigate on the specified route of flight (the FDE Prediction Program determines whether the GPS constellation is robust enough to provide a navigation solution for the specified route of flight). The trainer software and the document ‘400/500 Series FDE Prediction Instructions’ (190-00643-00) are available on Garmin’s web site for free download ([www.garmin.com](http://www.garmin.com)).



Figure 12-2 Garmin 400 Series Trainer Software

## SECTION 13: MESSAGES, ABBREVIATIONS, AND NAV TERMS

### 13.1 MESSAGES

The GNS 430 uses a flashing 'MSG' annunciator at the bottom of the screen (directly above the **MSG** Key) to alert the pilot of any important information or warnings. While most messages are advisory in nature, warning messages may require pilot intervention.

When the 'MSG' annunciator flashes, press the **MSG** Key to display the message. Press the **MSG** Key again to return to the previous page.

The following is a list of available messages and their meanings:

**Airspace ahead -- less than 10 minutes** - The GPS-calculated course is projected to enter a special use airspace within 10 minutes. This message is automatically disabled within 30 nm of an arrival airport, when an approach is loaded.

**Airspace near and ahead** - The GPS-calculated position is within 2 nm of the boundary of a special use airspace and the course is projected to enter the airspace within 10 minutes. This message is automatically disabled within 30 nm of an arrival airport, when an approach is loaded.

**All data referenced to True North** - The GNS 430 has not detected a NavData card in the left data card slot.

**Altitude input failure** - The GNS 430 is configured to receive altitude serializer data (Icarus, Rosetta, or Shadin) and it is not being received. Or, the data was being received, but has been interrupted. If a grey code altitude input is available, it is used instead. If the problem persists, contact a Garmin dealer and check the installation and installation settings. When this message occurs, no pilot action is required if enough satellites are available for a 3D position fix (provided no RAIM warnings are present). However, if only a 2D position fix is possible, the pilot should maintain the GPS altitude within 1,000 feet of pressure altitude by entering the altitude on the Position Page.

**Approach is not active** - The approach could not transition to 'active', at 2 nm or closer to the FAF. Verify that 'SUSP' DOES NOT appear directly above the **OBS** Key, indicating the auto waypoint sequencing is suspended. This message also appears if Receiver Autonomous Integrity Monitoring (RAIM) has determined that sufficient GPS satellite coverage DOES NOT exist for the current phase of flight (along with a 'RAIM not available from FAF to MAP' message).

**Approaching target altitude** - The current GPS-computed altitude is within 500 feet of the final Vertical Navigation target altitude.

**Approaching VNAV profile** - The aircraft is within one minute of reaching the initial Vertical Navigation descent, or climb, point.

**Arrival at waypoint [waypoint name]** - The aircraft is within the arrival alarm circle for the indicated waypoint. The size of the arrival alarm circle is defined from the 'CDI/Alarms' menu option on the Setup 1 Page.

**Cannot navigate locked FPL** - The pilot has attempted to navigate a flight plan (FPL) with one or more locked waypoints. A waypoint can be 'locked' when the NavData card is replaced and the waypoint(s) does not exist in the new database.

**Can't change an active waypoint** - An attempt has been made to modify the position of the active 'to' or 'from' waypoint. The GNS 430 does not allow modifications to user waypoints currently being utilized for navigation guidance.

**Can't delete an active or FPL waypoint** - An attempt has been made to delete the active 'to' or 'from' waypoint. The GNS 430 will not allow the deletion of user waypoints currently being utilized for navigation guidance.

**CDI key stuck** - The **CDI** Key is stuck in the enabled (or pressed) state. Try pressing the **CDI** Key again to cycle its operation. If the message persists, contact a Garmin dealer for assistance.

**Check unit cooling** - The GNS 430 has detected excessive display backlighting temperature. The backlighting has been automatically dimmed to reduce the temperature. Check for adequate ventilation or check cooling air flow. Contact a Garmin dealer for assistance.

**COM has failed** - The GNS 430 has detected a failure in its communications transceiver. The COM transceiver is not available and the unit should be returned to a Garmin dealer for service.

**COM is not responding** - Internal system-to-system communication between the main processor and the COM transceiver has failed. Operational status of the COM transceiver is unknown and the unit should be returned to a Garmin dealer for service.

**COM needs service** - The GNS 430 has detected a failure in its communications transceiver. The COM transceiver may still be usable, but the unit should be returned (at the earliest convenience) to a Garmin dealer for service.

**COM push-to-talk key stuck** - The external push-to-talk (PTT) switch is stuck in the enabled (or pressed) state. Try pressing the PTT switch again to cycle its operation. If the message persists, contact a Garmin dealer for assistance.

**COM remote transfer key is stuck** - The remote COM transfer switch is stuck in the enabled (or pressed) state. Try pressing the switch again to cycle its operation. If the message persists, contact a Garmin dealer for assistance.

**COM transfer key stuck** - The **COM Flip-flop** Key is stuck in the enabled (or pressed) state. Try pressing the **COM Flip-flop** Key again to cycle its operation. If the message persists, contact a Garmin dealer for assistance.

**COM transmitter power has been reduced** - The GNS 430 has detected excessive unit temperature and/or an insufficient voltage level. The COM transceiver transmit power has been automatically reduced to compensate for the condition. For excessive temperatures, check for adequate ventilation or check cooling air flow. If the message persists, contact a Garmin dealer for assistance.

**Data card failure** - The GNS 430 has detected a problem with the NavData card. The data is not usable and the card should be returned to Jeppesen or a Garmin dealer.

**Data transfer cancelled (crossfill is busy)**

- An attempt to transfer flight plan data during a unit-to-unit crossfill was cancelled. The host unit is busy or unable to communicate. Wait until any previous crossfill operation is complete before attempting the transfer again.

**Data transfer cancelled (data invalid)** - An attempt to transfer a single user waypoint during a unit-to-unit crossfill was cancelled. No waypoint was specified on the Crossfill Page. Select a user waypoint and attempt the transfer again.

**Data transfer cancelled (version mismatch)**

- An attempt to transfer data during a unit-to-unit crossfill was cancelled. The database versions of the two GNC 420s are not identical. If necessary, update the database(s) so they match. Contact Jeppesen or your Garmin dealer for assistance.

**Data transfer error, please re-transmit** - An error was detected during unit-to-unit crossfill of user data (user waypoints and/or flight plans). The data transfer should be attempted again.

**Data transfer is complete** - The unit-to-unit crossfill of user waypoint data has finished.

**Database changed, validate user modified procedures** - One or more approaches, departures, or arrivals have been modified from their original published form. When the NavData card is replaced (database update), the changes in the new database must be manually verified. This message occurs each time a flight plan containing a modified procedure (generated from a prior database version) is activated. To eliminate the message, re-create the flight plan from the new database, then make the desired modifications.

**Degraded accuracy** - GPS position accuracy has been degraded and RAIM is not available. Poor satellite geometry (or coverage) has resulted in a horizontal DOP greater than 4.0. Additional cross-checking using another navigation source is required to verify the integrity of the GPS position.

**Display backlight failure** - The GNC 420 has detected a failure in the display backlighting. The unit should be taken to your Garmin dealer for service.

**Do not use for navigation** - The GNC 420 is in Demo Mode and must not be used for actual navigation.

**FPL has been truncated** - The flight plan (FPL) was truncated because not enough room existed to insert an approach, departure, or arrival. This message also appears when an approach has been deleted from a stored flight plan because an approach could not be found. These conditions may occur upon power up when a database change increases the number of waypoints in, or removes an approach from, an instrument procedure.

**FPL is full - remove unnecessary waypoints** - An attempt has been made to add more than 31 waypoints to a flight plan (FPL). The GNC 420 does not allow more than 31 waypoints per flight plan.

**FPL leg will not be smoothed** - The upcoming flight plan (FPL) leg is too short for smooth waypoint transitions. Expect a rapid change in the CDI.

**FPL waypoint is locked** - At least one flight plan (FPL) waypoint is locked because the waypoint has been removed from the current NavData card (database change), the data card is missing, or the data card has failed.

**FPL waypoint moved** - The position data for one or more flight plan (FPL) waypoints moved at least 0.33 arc minutes in the current NavData card (database change).

**FPL waypoint was deleted** - At least one flight plan (FPL) waypoint is no longer available when a new NavData card was installed (database change).

**G/S has failed** - The GNS 430 has detected a failure in its glideslope receiver. The glideslope receiver is not available and the unit should be returned to a Garmin dealer for service.

**G/S is not responding** - Internal system-to-system communication between the main processor and the glideslope receiver has failed. Operational status of the glideslope receiver is unknown and the unit should be returned to a Garmin dealer for service.

**G/S needs service** - The GNS 430 has detected a failure in its glideslope receiver. The glideslope receiver may still be usable, but the unit should be returned (at the earliest convenience) to a Garmin dealer for service.

**GPS has failed** - The GNS 430 has detected a failure in its GPS receiver. The GPS receiver is not available and the unit should be returned to a Garmin dealer for service.

**GPS is not responding** - Internal system-to-system communication between the main processor and the GPS receiver has failed. Operational status of the GPS receiver is unknown and the unit should be returned to a Garmin dealer for service.

**GPS needs service** - The GNS 430 has detected a failure in its GPS receiver. The GPS receiver may still be usable, but the unit should be returned (at the earliest convenience) to a Garmin dealer for service.

**GPS stored data was lost** - Satellite almanac, ephemeris and time data have been lost due to a memory battery failure, system reset, or data expiration (data over six months old).

**Heading input failure** - The heading selection on the external HSI's (or CDI's) OBS course selector cannot be read properly. A Garmin dealer may need to check the installation.

**Inside airspace** - A GPS-calculated position lies within the boundaries of a special use airspace. This message is automatically disabled within 30 nm of an arrival airport, when an approach is loaded.

**Invalid closest pt of FPL** - A closest point cannot be created from the waypoint entered on the 'Closest point of flight plan' window. This occurs when the selected waypoint is beyond the limits of all legs in the flight plan, too far away, or when a unique waypoint name for the closest point cannot be created.

**Invalid FPL modification** - An attempt was made to modify the final course segment (FAF to MAP) of an instrument approach. The GNS 430 does not allow the modifications.

**Invalid waypoint ident** - An attempt was made to create a user waypoint with an invalid name. The GNS 430 does not allow spaces between characters in the waypoint name.

**MAIN processor requires service** - The GNS 430 has detected a failure in the main system processor. The GNS 430 is not usable and should be taken to a Garmin dealer for service.

**Memory battery low** - The internal battery that sustains user memory is low and should be replaced by a Garmin dealer as soon as possible. Failure to do so may result in loss of stored data, including flight plans, user waypoints, unit settings, and satellite data.

**Near airspace -- less than 2 nm** - The GPS-calculated position is within 2 nm of a special use airspace boundary, but the aircraft is not projected to enter the airspace. This message is automatically disabled within 30 nm of an arrival airport, when an approach is loaded.

**Need altitude - display position page** - The GPS receiver needs altitude input in order to start and/or continue 2D navigation. Select the Position Page and verify the altitude reading. If the altitude is in error by more than 500 feet, enter the current altitude as accurately as possible. An inaccurate altitude directly translate into inaccurate position information.

**No altitude input is being received** - No altitude data is being received from RS-232 (Serializer: Icarus, Rosetta or Shadin) or grey code inputs. If the problem persists, contact a Garmin dealer and check the installation and installation settings. When this message occurs, no pilot action is required if enough satellites are available for a 3D position fix (provided no RAIM warnings are present). However, if only a 2D position fix is possible, the pilot should maintain the GPS altitude within 1,000 feet of pressure altitude by entering the altitude on the Position Page.

**No basemap data available** - The GNS 430 has detected a failure in the built-in basemap (land data) memory. Land data does not appear on the Map Page. Other unit functions continue to work normally, however the GNS 430 should be taken to a Garmin dealer for service at the earliest convenience.

**Non-WGS84 wpt navigation** - The active 'to' and/or 'from' waypoints are based upon a map datum other than WGS 84 and cannot be converted from that map datum to WGS 84. Expect some error in the position of the waypoint(s) and cross-check with an alternate means of navigation.

**Not receiving input data on 429 Channel 1** - No data has been received on the ARINC 429 channel 1 connection for a period exceeding five seconds. If the problem persists, the installation should be checked by a Garmin dealer.

**Not receiving input data on 429 Channel 2** - No data has been received on the ARINC 429 channel 2 connection for a period exceeding five seconds. If the problem persists, the installation should be checked by a Garmin dealer.

**Not receiving input data on 232 Channel 1 -**

No data has been received on the RS-232 channel 1 connection for a period exceeding ten seconds. If the problem persists, the installation should be checked by a Garmin dealer.

**OBS key stuck** - The **OBS** Key is stuck in the enabled (or pressed) state. Try pressing the **OBS** Key again to cycle its operation. If the message persists, contact a Garmin dealer for assistance.

**Poor GPS coverage** - The GPS receiver cannot acquire a sufficient number of satellites to compute a position and provide navigation.

**Power down and re-initialize** - The GNS 430 cannot calculate a position due to abnormal satellite conditions. The unit is unusable until power has been cycled off and back on. Abnormal satellite conditions may exist and the pilot may need to use an alternate means of navigation.

**RAIM is not available** - Receiver Autonomous Integrity Monitoring (RAIM) has determined that sufficient GPS satellite coverage does not exist for the current phase of flight. (The CDI/HSI NAV flag also appears.) Select an alternate source for navigation guidance, such as the GNS 430's VLOC receiver.

**RAIM not available from FAF to MAP waypoints** - When performing an instrument approach, Receiver Autonomous Integrity Monitoring (RAIM) has determined that sufficient GPS satellite coverage does not exist to meet the required protection limits. Select an alternate source for navigation guidance, such as the GNS 430's VLOC receiver (for a VOR or localizer-based approach).

**RAIM position warning** - Although sufficient GPS satellite coverage may exist, Receiver Autonomous Integrity Monitoring (RAIM) has determined the information from one or more GPS satellites may be in error. The resulting GPS position may be in error beyond the limits allowed for the current phase of flight. Cross-check the position with an alternate navigation source. If the warning occurs during a final approach segment (FAF to MAP), execute the published missed approach.

**Scheduler message - [user entered text]** - The user-entered scheduler message time has expired, and the scheduler message is displayed.

**Searching the sky** - The GNS 430 is searching the sky for GPS satellite almanac data or the GPS receiver is in AutoLocate Mode. Allow the unit to complete data collection (approximately five minutes) before turning it off.

**Select appropriate frequency for approach** - The aircraft is inbound and within 3 nm of the FAF; and the active VLOC frequency does not match the published frequency for the approach. Tune the standby VLOC frequency to the proper frequency and press the **VLOC Flip-flop** Key to 'activate' the frequency.

**Select auto sequence mode** - The **OBS** Key was pressed, disabling auto sequencing of waypoints (in a flight plan or instrument procedure). The **OBS** Key should be pressed again to enable auto sequencing, because 1) no destination waypoint has been selected or 2) the GPS receiver cannot currently determine its position.



**Select VLOC on CDI for approach** - The aircraft is inbound and within 3 nm of the FAF; and the active approach is not a GPS-approved approach. Verify that the VLOC receiver is tuned to the proper frequency and press the **CDI** Key to display 'VLOC' (directly above the **CDI** Key).

**Set course to [###]°** - The course select for the external CDI (or HSI) should be set to the specified course. The message only occurs when the current selected course is greater than 10° different from the desired track.

**Steep turn ahead** - This message appears approximately one minute prior to a turn in one of the following three conditions: 1) the turn requires a bank angle in excess of 25° in order to stay on course, 2) the turn requires a course change greater than 175°, or 3) during a DME arc approach the turn anticipation distance exceeds 90 seconds.

**Stored data was lost** - All user waypoints, flight plans, and system settings have been lost due to a memory battery failure or system reset.

**Terrain** - See Section 11.3 for complete list of TERRAIN related Alerts and Annunciations.

**Terrain configuration conflict** - The hardware configuration does not match the terrain software configuration. The operational status of the terrain components is unknown and the unit should be returned to a Garmin dealer for service.

**Terrain configuration has changed** - The software has detected a change in the terrain configuration.

**Terrain has failed** - The terrain functionality self-test has failed. The operational status of the terrain components is unknown and the unit should be returned to a Garmin dealer for service.

**Timer has expired** - The count down timer has reached zero.

**Traffic device needs service** - Either the TCAD battery or the TCAD interrogation device has failed. If the message persists, contact a Garmin dealer for assistance.

**Unit configuration has changed** - The GNS 430 has detected a failure (during initial power up) in its system configuration. Some system components may be unusable. Try cycling power off and back on. If the message persists, contact a Garmin dealer for assistance.

**User card format unknown** - A data card has been inserted, but the format of the card is not recognized.

**VLOC has failed** - The GNS 430 has detected a failure in its VLOC receiver. The VLOC receiver is not available and the unit should be returned to a Garmin dealer for service.

**VLOC is not responding** - Internal system-to-system communication between the main processor and the VLOC receiver has failed. Operational status of the VLOC receiver is unknown and the unit should be returned to a Garmin dealer for service.

**VLOC needs service** - The GNS 430 has detected a failure in its VLOC receiver. The VLOC receiver may still be usable, but the unit should be returned (at the earliest convenience) to a Garmin dealer for service.

**VLOC remote transfer key is stuck** - The remote VLOC transfer switch is stuck in the enabled (or pressed) state. Try pressing the switch again to cycle its operation. If the message persists, contact a Garmin dealer for assistance.

**VLOC transfer key stuck** - The **VLOC Flip-flop** Key is stuck in the enabled (or pressed) state. Try pressing the **VLOC Flip-flop** Key again to cycle its operation. If the message persists, contact a Garmin dealer for assistance.

**Waypoint already exists** - The name just entered for a user waypoint already exists in memory.

**Waypoint(s) have been replaced** - One or more user waypoints were updated during a unit-to-unit crossfill operation.

**Waypoint memory is full** - The pilot has used all 1000 user waypoint locations in the GNS 430's memory. Delete unwanted waypoint to make room for new entries.

**WGS 84 datum has been selected** - The system map datum was changed to WGS 84 because the selected map datum was removed from the current NavData card (database update), the data card is missing, or the data card has failed.

## 13.2 ABBREVIATIONS

The following is a list of abbreviations used on the GNS 430 and their meanings:

|                  |                                   |              |                               |
|------------------|-----------------------------------|--------------|-------------------------------|
| <b>ACTV</b>      | Active                            | <b>CUM</b>   | Cumulative                    |
| <b>ALT</b>       | Altitude                          | <b>DB</b>    | Database                      |
| <b>APPRCHING</b> | Approaching                       | <b>DEN</b>   | Density                       |
| <b>APR</b>       | Approach                          | <b>DEP</b>   | Departure                     |
| <b>APT</b>       | Airport                           | <b>DIS</b>   | Distance                      |
| <b>ARSPC</b>     | Airspace                          | <b>DME</b>   | Distance Measuring Equipment  |
| <b>ARTCC</b>     | Air Route Traffic Control Center  | <b>DOP</b>   | Dilution of Precision         |
| <b>ARVL</b>      | Arrival                           | <b>DTK</b>   | Desired Track                 |
| <b>AUX</b>       | Auxiliary                         | <b>EFF</b>   | Efficiency                    |
| <b>AVGAS</b>     | Aviation Grade Gasoline           | <b>ELEV</b>  | Elevation                     |
| <b>AVTN</b>      | Aviation                          | <b>ENDUR</b> | Endurance                     |
| <b>BARO</b>      | Barometric Pressure               | <b>ENR</b>   | Enroute                       |
| <b>BRG</b>       | Bearing To                        | <b>ENT</b>   | Enter                         |
| <b>°C</b>        | Degree Celsius                    | <b>EPE</b>   | Estimated Position Error      |
| <b>C/V</b>       | COM/VLOC                          | <b>ESA</b>   | Enroute Safe Altitude         |
| <b>CAS</b>       | Calibrated Airspeed               | <b>ETA</b>   | Estimated Time of Arrival     |
| <b>CDI</b>       | Course Deviation Indicator        | <b>ETE</b>   | Estimated Time Enroute        |
| <b>CLR</b>       | Clear                             | <b>°F</b>    | Degrees Fahrenheit            |
| <b>COM</b>       | Communications Transceiver        | <b>FDE</b>   | Fault Detection and Exclusion |
| <b>CRSR</b>      | Cursor                            | <b>FF</b>    | Fuel Flow                     |
| <b>CTA</b>       | ICAO Control Area                 | <b>FLOW</b>  | Total Fuel Flow               |
| <b>CTAF</b>      | Common Traffic Advisory Frequency | <b>FOB</b>   | Fuel On Board                 |
| <b>CTR</b>       | Center (ARTCC)                    | <b>FPL</b>   | Flight Plan                   |
| <b>CTS</b>       | Course To Steer                   | <b>fpm</b>   | Feet Per Minute               |
|                  |                                   | <b>FREQ</b>  | Frequency                     |
|                  |                                   | <b>FSS</b>   | Flight Service Station        |

## SECTION 13 – MESSAGES, ABBREVIATIONS, & NAV TERMS

|                |                              |               |                              |
|----------------|------------------------------|---------------|------------------------------|
| <b>ft</b>      | Feet                         | <b>LOC</b>    | Localizer                    |
| <b>G/S</b>     | Glideslope                   | <b>LRES</b>   | Left-over Fuel Reserve Time  |
| <b>gl</b>      | Gallons                      | <b>Lrg</b>    | Large                        |
| <b>GPS</b>     | Global Positioning System    | <b>lt</b>     | Liters                       |
| <b>GS</b>      | Ground Speed                 | <b>°M</b>     | Degrees Magnetic             |
| <b>HDG</b>     | Heading                      | <b>m</b>      | Meters                       |
| <b>hg</b>      | Inches of Mercury            | <b>mb</b>     | Millibars of Pressure        |
| <b>HUL</b>     | Horizontal Uncertainty Level | <b>Med</b>    | Medium                       |
| <b>HWY</b>     | Highway                      | <b>MHz</b>    | Megahertz                    |
| <b>ID</b>      | Identifier                   | <b>mi</b>     | Statute Miles                |
| <b>ig</b>      | Imperial Gallons             | <b>MOA</b>    | Military Operations Area     |
| <b>ILS</b>     | Instrument Landing System    | <b>mph</b>    | Statute Miles Per Hour       |
| <b>IND</b>     | Indicated                    | <b>mpm</b>    | Meters Per Minute            |
| <b>INT</b>     | Intersection                 | <b>mps</b>    | Meters Per Second            |
| <b>INTEG</b>   | Integrity                    | <b>MSA</b>    | Minimum Safe Altitude        |
| <b>kg</b>      | Kilograms                    | <b>MSG</b>    | Message                      |
| <b>kHz</b>     | Kilohertz                    | <b>MSL</b>    | Mean Sea Level               |
| <b>km</b>      | Kilometers                   | <b>mul</b>    | Multicom                     |
| <b>kph</b>     | Kilometers Per Hour          | <b>NATNL</b>  | National                     |
| <b>kt</b>      | Knots                        | <b>NAV</b>    | Navigation                   |
| <b>LAT/LON</b> | Latitude/Longitude           | <b>NAVAID</b> | Navigational Aid             |
| <b>lb</b>      | Pounds                       | <b>NDB</b>    | Non-Directional Radio Beacon |
| <b>LCL</b>     | Local                        | <b>nm</b>     | Nautical Miles               |
| <b>LFOB</b>    | Left-over Fuel On Board      | <b>NRST</b>   | Nearest                      |
|                |                              | <b>NUM</b>    | Number                       |
|                |                              | <b>OBS</b>    | Omnibearing Selector         |

|                  |  |              |   |
|------------------|--|--------------|---|
| <b>OCN</b>       | Oceanic                                  | <b>TERM</b>  | Terminal  |
| <b>PPOS</b>      | Present Position                         | <b>TKE</b>   | Track Angle Error                                     |
| <b>PROC</b>      | Procedure(s)                             | <b>TMA</b>   | ICAO Terminal Control Area                            |
| <b>PROV</b>      | Province                                 | <b>TRANS</b> | Transition  |
| <b>PWR</b>       | Power                                    | <b>TRFC</b>  | Traffic   |
| <b>RAD</b>       | Radial                                   | <b>TRK</b>   | Track (also Ground Track)                             |
| <b>RAIM</b>      | Receiver Autonomous Integrity Monitoring | <b>TRSA</b>  | Terminal Radar Service Area                           |
| <b>REF</b>       | Reference                                | <b>twr</b>   | Tower   |
| <b>REQ</b>       | Required/Requirements                    | <b>TX</b>    | Transmit  |
| <b>RESTRICTD</b> | Restricted                               | <b>uni</b>   | Unicom  |
| <b>RNG</b>       | Range                                    | <b>UTC</b>   | Coordinated Universal Time (also GMT or 'zulu')       |
| <b>RX</b>        | Receive                                  | <b>VAR</b>   | Variation   |
| <b>SID</b>       | Standard Instrument Departure            | <b>VER</b>   | Version   |
| <b>Sml</b>       | Small                                    | <b>VFR</b>   | Visual Flight Rules                                   |
| <b>SPD</b>       | Speed                                    | <b>VLOC</b>  | VOR/Localizer Receiver                                |
| <b>SQ</b>        | Squelch                                  | <b>VNAV</b>  | Vertical Navigation                                   |
| <b>SRFC</b>      | Surface                                  | <b>VOL</b>   | Volume  |
| <b>STAR</b>      | Standard Terminal Arrival Route          | <b>VOR</b>   | VHF (Very High Frequency) Omnidirectional Radio Range |
| <b>SUA</b>       | Special Use Airspace                     | <b>VS</b>    | Vertical Speed  |
| <b>°T</b>        | Degree True                              | <b>VSR</b>   | Vertical Speed Required                               |
| <b>TACAN</b>     | Tactical Air Navigation                  | <b>WPT</b>   | Waypoint  |
| <b>TAS</b>       | True Airspeed                            | <b>WX</b>    | Weather   |
| <b>TAT</b>       | Total Air Temperature                    | <b>XTK</b>   | Crosstrack Error                                      |
| <b>TEMP</b>      | Temperature                              |              |   |

### 13.3 NAVIGATION TERMS

The following navigation terms are used on the GNS 430 and in this Pilot's Guide. Refer to Figures 11-1 and 11-2 for graphic representation of navigation terms.

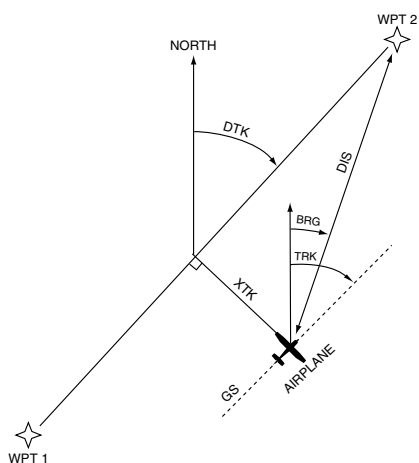

**Figure 13-1 Illustrated NAV Terms**

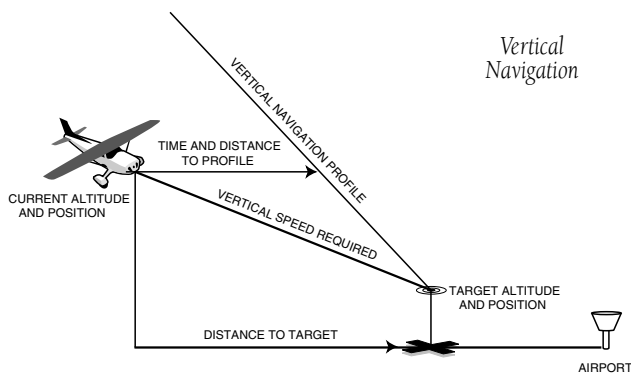

**Figure 13-2 Illustrated Vertical NAV Terms**

**ALT (altitude)** - Height above mean sea level (MSL).

**BRG (bearing)** - The compass direction from the present position to a destination waypoint.

**CAS (calibrated airspeed)** - Indicated airspeed corrected for instrument errors.

**CTS (course to steer)** - The recommended direction to steer in order to reduce course error or stay on course. Provides the most efficient heading to get back to the desired course and proceed along the flight plan.

**CUM (cumulative)** - The total of all legs in a flight plan (such as 'cumulative distance').

**DIS (distance)** - The 'great circle' distance from the present position to a destination waypoint.

**DOP (dilution of precision)** - A measure of satellite geometry quality on a scale of one to ten (lowest numbers are best, highest numbers are worst).

**DTK (desired track)** - The desired course between the active 'from' and 'to' waypoints.

**EFF (efficiency)** - A measure of fuel consumption, expressed in distance per fuel units (e.g., nautical miles per gallon).

**ENDUR (endurance)** - Flight endurance, or total available flight time based upon available fuel.

**EPE (estimated position error)** - A measure of satellite geometry quality and additional factors, expressed as a horizontal position error in feet or meters.

**ESA (enroute safe altitude)** - The recommended minimum altitude within ten miles, left or right, of the desired course on an active flight plan or direct-to.

**ETA (estimated time of arrival)** - The estimated time at which the aircraft will reach the destination waypoint, based upon current speed and track.

**ETE (estimated time enroute)** - The time it will take to reach the destination waypoint, from present position, based upon current ground speed.

**FF (fuel flow)** - The fuel flow rate, expressed in fuel units per time (e.g., gallons per hour).

**FOB (fuel on board)** - The total amount of usable fuel on board the aircraft.

**GS (ground speed)** - The velocity the aircraft is travelling relative to a ground position.

**HDG (heading)** - The direction an aircraft is pointed, based upon indications from a magnetic compass or a properly set directional gyro.

**IND (indicated)** - Information provided by properly calibrated and set instrumentation in the aircraft panel (e.g., 'indicated altitude').

**LFOB (left-over fuel onboard)** - The amount of fuel remaining on board after the completion of a one or more legs of a flight plan (or a direct-to).

**LRES (left-over fuel reserve)** - The amount of fuel remaining on board after the completion of a one or more legs of a flight plan (or a direct-to), expressed in time and based upon a known fuel consumption (flow) rate.

**MSA (minimum safe altitude)** - Uses Grid Minimum Off-route Altitudes (Grid MORAs) to determine a safe altitude within ten miles of the present position. Grid MORAs are one degree latitude by one degree longitude in size and clear all reference points within the grid by 1000 feet in areas where the highest reference point is 5000 feet MSL or lower. If the highest reference point is above 5000 feet, the Grid MORA will clear the highest reference point by 2000 feet.

**TKE (track angle error)** - The angle difference between the desired track and the current track. An arrow indicates the proper direction to turn to reduce TKE to zero.

**TRK (track)** - The direction of movement relative to a ground position. Also referred to as 'ground track'.

**VSR (vertical speed required)** - The vertical speed necessary to descend/climb from current position and altitude to a defined target position and altitude, based upon the current ground speed.

**XTK (crosstrack error)** - The distance the aircraft is off a desired course in either direction, left or right.

Blank Page



## APPENDIX A: DATA CARD USE

The Jeppesen NavData card, and the Terrain Data Card (if applicable) supplied with the GNS 430 can be installed or removed when the GNS 430 is on or off. If the NavData card is not present when the unit is turned on, a 'No Jeppesen Aviation Database - Limited to user defined waypoints' message appears on the Database Confirmation Page. If the NavData card is removed during operation, a 'Data card removed - Unit will restart in 30 seconds' warning is displayed. A counter begins to count down and, if the card is not replaced within 30 seconds, the GNS 430 automatically re-initializes. Pressing the **ENT** Key will manually re-initialize the unit.

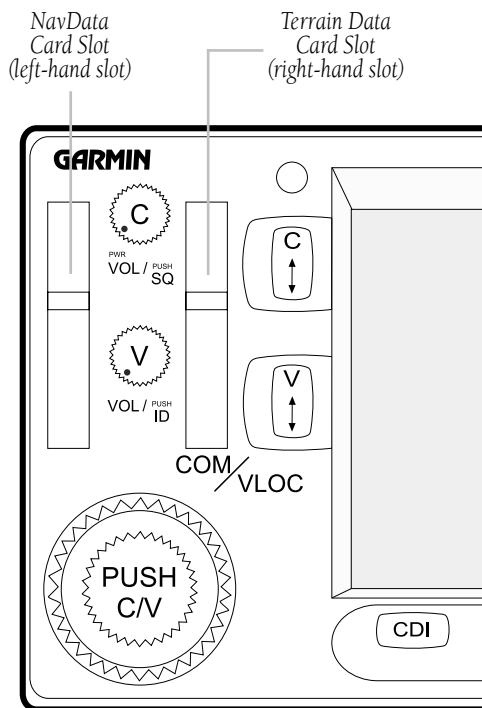

Figure A-1 Data Card Slot Locations



*NOTE: There are two data card slots on the face of the GNS 430 (Figure A-1). The Jeppesen NavData card should be inserted in the left-hand slot. The right-hand slot is provided for the Terrain Data Card.*

### To insert the NavData or Terrain Data card (Figure A-2):

- 1) Place the card into the appropriate card slot, with the label facing to the left and the swing arm handle at the bottom front.
- 2) Press the data card into place until it seats on the internal connector and the front of the card is flush with the face of the GNS 430 unit.
- 3) If the swing arm handle is up, gently lower the handle and push it into place—flush with the face of the GNS 430 unit.

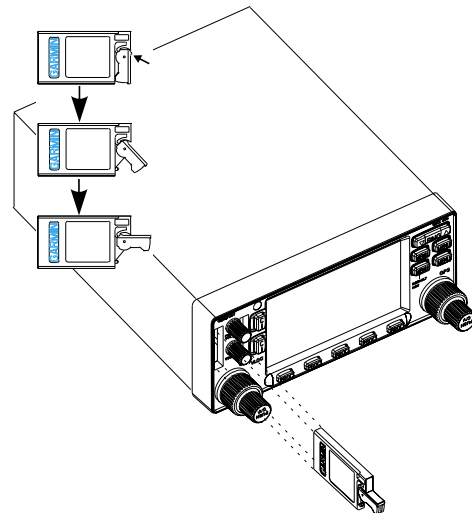

Figure A-2 Data Card Insertion/Removal Detail

**To remove the NavData or Terrain data card  
(Figure A-2):**

- 1) Gently press on the tab—using a slight upward motion—at the front center of the data card. This partially deploys the swing arm handle.
- 2) Rotate the swing arm handle upward (and outward) until it locks into place, perpendicular to the face of the GNS 430 unit.
- 3) Grasp the top and bottom surfaces of the swing arm handle between your thumb and forefinger, and pull directly away from the face of the GNS 430 unit to remove the data card.

## **APPENDIX B: SPECIFICATIONS**

### **PHYSICAL**

Unit Size: 6.25'W x 11.00'D x 2.65'H  
(159 mm x 279 mm x 67 mm)

Unit Weight: 6.6 pounds installed (3.0 kg)

### **POWER\***

Input: 28 Vdc (early 430, all 430A units)  
14/28 Vdc (later 430 units)

### **ENVIRONMENTAL**

Temperature: -20°C to +55°C (operating range)  
(-4°F to +131°F)

Humidity: 95% non-condensing

Altitude: -1,500 ft to 50,000 ft  
(-457 m to 15,240 m)

### **GPS PERFORMANCE**

Receiver: 12 parallel channel PhaseTrac12™

Acquisition Time: 12 seconds (warm)  
45 seconds (cold)

Update Rate: Once per second, continuous

Accuracy: Position - 15 meters (49 ft) RMS\*\*  
Velocity - 0.1 knot RMS steady state

Dynamics: 999 kts maximum velocity  
6g maximum acceleration

### **VHF COM PERFORMANCE**

Channels: 760 (25 kHz spacing)  
or 2280 (8.33 kHz spacing)

Frequency Range: 118.000 MHz to 136.975 MHz

Transmit Power: 10 watts minimum (430)  
16 watts minimum (430A)

### **VOR PERFORMANCE**

Frequency Range: 108.00 MHz to 117.95 MHz

### **LOCALIZER PERFORMANCE**

Frequency Range: 108.10 MHz to 111.95 MHz

### **GLIDESLOPE PERFORMANCE**

Frequency Range: 329.15 MHz to 335.00 MHz

### **INTERFACES**

ARINC 429; Aviation RS-232; CDI/HSI;  
RMI (digital:clock/data); Superflag Out;  
Altitude (serial: Icarus, Shadin, Rosetta, or  
encoded: Gillham/Greycodes); Fuel Sensor; Fuel/  
Air Data

*\* Earlier versions of the 430 were designed to be used with 28 Vdc power only. For questions on a particular installation, please refer to a Garmin authorized service center.*

*\*\*Subject to accuracy degradation to 100m 2DRMS under the U.S. DOD-imposed Selective Availability Program.*

Blank Page

## APPENDIX C: MAP DATUMS

|                             |   |                              |  |
|-----------------------------|---|------------------------------|--|
| <b>Adindan</b>              | Ethiopia, Mali, Senegal, Sudan                                | <b>European 1950</b>         | Austria, Belgium, Denmark, Finland, France, Germany, Gibraltar, Greece, Italy, Luxembourg, Netherlands, Norway, Portugal, Spain, Sweden, Switzerland |
| <b>Afgooye</b>              | Somalia   | <b>European 1979</b>         | Austria, Finland, Netherlands, Norway, Spain, Sweden, Switzerland  |
| <b>AIN EL ABD 1970</b>      | Bahrain Island, Saudi Arabia                                  | <b>Finland Hayford 1910</b>  | Finland  |
| <b>Anna 1 Astro 1965</b>    | Cocos Islands   | <b>G. SEGARA</b>             | Borneo   |
| <b>ARC 1950</b>             | Botswana, Lesotho, Malawi, Swaziland, Zaire, Zambia, Zimbabwe | <b>Gandajika Base</b>        | Republic of Maldives   |
| <b>ARC 1960</b>             | Kenya, Tanzania   | <b>Geodetic Datum 1949</b>   | New Zealand  |
| <b>Ascension Is 1958</b>    | Ascension Island  | <b>GGRS 87</b>               | Greece   |
| <b>Astro B4 Sorol Atoll</b> | Tern Island   | <b>Guam 1963</b>             | Guam Island  |
| <b>Astro Beacon 'E'</b>     | Iwo Jima Island   | <b>Gux 1 Astro</b>           | Guadalcanal Island   |
| <b>Astro Dos 71/4</b>       | St. Helena Island   | <b>Herat North</b>           | Afghanistan  |
| <b>Astronomic Stn 1952</b>  | Marcus Island   | <b>Hjorsey 1955</b>          | Iceland  |
| <b>Australian Geod 1966</b> | Australia, Tasmania Island                                    | <b>Hong Kong 1963</b>        | Hong Kong  |
| <b>Australian Geod 1984</b> | Australia, Tasmania Island                                    | <b>HU-TZU-SHAN</b>           | Taiwan   |
| <b>AUSTRIA NS</b>           | Austria   | <b>Indian Bngldsh NEPAL</b>  | Bangladesh, India, Nepal   |
| <b>BELGIUM 1950</b>         | Belgium   | <b>INDIAN MEAN VALUE</b>     | India  |
| <b>Bellevue (IGN)</b>       | Efate and Erromango Islands                                   | <b>Indian Thailand Vietn</b> | Thailand, Vietnam  |
| <b>Bermuda 1957</b>         | Bermuda Islands   | <b>INDONESIA 74</b>          | Indonesia  |
| <b>Bogota Observatory</b>   | Colombia  | <b>Ireland 1965</b>          | Ireland  |
| <b>BUKIT RIMPAH</b>         | Indonesia   | <b>ISTS 073 Astro 1969</b>   | Diego Garcia   |
| <b>CAMP AREA ASTRO</b>      | Antarctica  | <b>Johnston Island 1961</b>  | Johnston Island  |
| <b>Campo Inchauspe</b>      | Argentina   | <b>KANDAWALA</b>             | Sri Lanka  |
| <b>Canton Astro 1966</b>    | Phoenix Islands   | <b>Kerguelen Island</b>      | Kerguelen Island   |
| <b>Cape</b>                 | South Africa  | <b>Kertau 1948</b>           | West Malaysia, Singapore   |
| <b>Cape Canaveral</b>       | Florida, Bahama Islands                                       | <b>L.C. 5 Astro</b>          | Cayman Brac Island   |
| <b>Carthage</b>             | Tunisia   | <b>Liberia 1964</b>          | Liberia  |
| <b>CH-1903</b>              | Switzerland   | <b>LUZON MEAN VALUE</b>      | Philippines  |
| <b>Chatham 1971</b>         | Chatham Island (New Zealand)                                  | <b>Luzon Mindanao Is</b>     | Mindanao Island  |
| <b>Chua Astro</b>           | Paraguay  | <b>Luzon Philippines</b>     | Philippines<br>(excluding Mindanao Isl.)   |
| <b>Corrego Alegre</b>       | Brazil  | <b>Mahe 1971</b>             | Mahe Island  |
| <b>DANISH GI 1934</b>       | Denmark   | <b>Marco Astro</b>           | Salvage Islands  |
| <b>Djakarta (BATAVIA)</b>   | Sumatra Island (Indonesia)                                    | <b>Massawa</b>               | Eritrea (Ethiopia)   |
| <b>Dos 1968</b>             | Gizo Island<br>(New Georgia Islands)                          | <b>Merchich</b>              | Morocco  |
| <b>Easter Island 1967</b>   | Easter Island   | <b>Midway Astro 1961</b>     | Midway Island  |
|                             |   | <b>Minna</b>                 | Nigeria  |
|                             |   | <b>NAD27 Alaska</b>          | North American 1927- Alaska  |

# APPENDIX C MAP DATUMS

|                             |  |                             |  |
|-----------------------------|--|-----------------------------|--|
| <b>NAD27 Bahamas</b>        | Bahamas (excluding San Salvador Island)  | <b>Prov So American '56</b> | Bolivia, Chile, Colombia, Ecuador, Guyana, Peru, Venezuela   |
| <b>NAD27 Canada</b>         | Canada (including Newfoundland Island)   | <b>Prov SO Chilean 1963</b> | South Chile  |
| <b>NAD27 Canal Zone</b>     | Canal Zone   | <b>Puerto Rico</b>          | Puerto Rico and Virgin Isl.  |
| <b>NAD27 Caribbean</b>      | Caribbean (Barbados, Caicos Islands, Cuba, Dom. Rep., Grd. Cayman, Jamaica, Leeward and Turks Islands) | <b>Qatar National</b>       | Qatar  |
| <b>NAD27 Centrl America</b> | Central America (Belize, Costa Rica, El Salvador, Guatemala, Honduras, Nicaragua)                      | <b>Qornoq</b>               | South Greenland  |
| <b>NAD27 CONUS</b>          | Mean Value (Continental U.S.)  | <b>Reunion</b>              | Mascarene Island   |
| <b>NAD27 Cuba</b>           | Cuba   | <b>Rome 1940</b>            | Sardinia Island  |
| <b>NAD27 Greenland</b>      | Greenland (Hayes Peninsula)  | <b>RT 90</b>                | Sweden   |
| <b>NAD27 Mexico</b>         | Mexico   | <b>Santo (Dos)</b>          | Espirito Santo Island  |
| <b>NAD27 San Salvadr Is</b> | San Salvador Island  | <b>Sao Braz</b>             | Sao Miguel, Santa Maria Islands (Azores)   |
| <b>NAD83</b>                | North American 1983- Alaska, Canada, Central America, CONUS, Mexico                                    | <b>Sapper Hill 1943</b>     | East Falkland Island   |
| <b>Nahrwan Masirah Is</b>   | Masirah Island (Oman)  | <b>Schwarzeck</b>           | Namibia  |
| <b>Nahrwan Saudi Arabia</b> | Saudi Arabia   | <b>South American 1969</b>  | Argentina, Bolivia, Brazil, Chile, Colombia, Ecuador, Guyana, Paraguay, Peru, Venezuela, Trinidad/Tobago |
| <b>Nahrwan Unitd Arab E</b> | United Arab Emirates   | <b>South Asia</b>           | Singapore  |
| <b>Naparima BWI</b>         | Trinidad and Tobago  | <b>SouthEast Base</b>       | Porto Santo and Madeira Islands  |
| <b>Netherland TRIAG '21</b> | Netherlands  | <b>SouthWest Base</b>       | Faial, Graciosa, Pico, Sao Jorge and Terceira Islands (Azores)   |
| <b>NOU TRIAG France</b>     | France   | <b>Tananarive obsv 1925</b> | Madagascar   |
| <b>NOU TRIAG Luxembourg</b> | Luxembourg   | <b>Timbalai 1948</b>        | Brunei and East Malaysia (Sarawak and Sabah)   |
| <b>Observatorio 1966</b>    | Corvo and Flores Islands (Azores)  | <b>Tokyo</b>                | Japan, Korea, Okinawa  |
| <b>Old Egyptian</b>         | Egypt  | <b>Tristan Astro 1968</b>   | Tristan da Cunha   |
| <b>Old Hawaiian Kauai</b>   | Kauai  | <b>Viti Levu 1916</b>       | Viti Levu Island/Fiji Islands  |
| <b>Old Hawaiian Maui</b>    | Maui   | <b>Wake-Eniwetok 1960</b>   | Marshall Islands   |
| <b>Old Hawaiian MEAN</b>    | Mean Value   | <b>WGS 72</b>               | World Geodetic System 1972   |
| <b>Old Hawaiian Oahu</b>    | Oahu   | <b>WGS 84</b>               | World Geodetic System 1984   |
| <b>Oman</b>                 | Oman   | <b>YACARE</b>               | Uruguay  |
| <b>Ord Srv Grt Britain</b>  | England, Isle of Man, Scotland, Shetland Islands, Wales  | <b>Zanderij</b>             | Surinam  |
| <b>Pico De Las Nieves</b>   | Canary Islands   |                             |  |
| <b>Pitcairn Astro 1967</b>  | Pitcairn Island  |                             |  |
| <b>PORTUGUESE 1973</b>      | Portugal   |                             |  |
| <b>POTSDAM</b>              | Germany  |                             |  |

## APPENDIX D: TROUBLESHOOTING Q & A

This section is designed to answer some of the common questions regarding the GNS 430's capabilities and operation. If there is a problem operating the unit, read through this appendix and refer to the reference section noted. If the answer to a particular question is not covered here, use the index to find the appropriate section elsewhere in this manual. If, after reading through the appropriate reference section, the answer cannot be found, please see an authorized dealer or contact Garmin directly at the address or phone numbers listed on page ii. Garmin is dedicated to supporting its products and customers.

### What is RAIM, and how does it affect approach operations?

RAIM is an acronym for Receiver Autonomous Integrity Monitoring, a GPS receiver function that performs a consistency check on all tracked satellites. RAIM ensures that the available satellite geometry allows the receiver to calculate a position within a specified protection limit (4 nm for oceanic, 2 nm for enroute, 1 nm for terminal and 0.3 nm for non-precision approaches).

During oceanic, enroute and terminal phases of flight, RAIM is available nearly 100% of the time. Because of the tighter protection limit on approaches, there may be times when RAIM is not available. The GNS 430 automatically monitors RAIM and warns the pilot with an alert message (Section 12) when it is not available, and the INTEG annunciator appears at the bottom left corner of the screen. If RAIM is not available when crossing the FAF, the pilot must fly the missed approach procedure. The GNS 430's RAIM prediction function (Section 12) also allows the pilot to see whether RAIM is available for a specified date and time.



*NOTE: If RAIM is not predicted to be available for the final approach course, the approach does not become active—as indicated by an 'Approach is not active' message, a 'RAIM not available from FAF to MAP' message and INTEG annunciator.*

### Why aren't there any approaches available for my flight plan?

Approaches are available for the final destination airport in a flight plan or as a direct-to (keep in mind that some VOR/VORTAC identifiers are similar to airport identifiers). If a destination airport does not have a GPS approach, the GNS 430 indicates 'NONE' for the available procedures—as listed on the Airport Approach Page (Figure D-1). For more information on selecting an approach, see Section 6.1.



Figure D-1 Airport Approach Page

**What happens when I select an approach?  
Can I store a flight plan with an approach,  
departure, or arrival?**

When loading an approach, departure, or arrival into the active flight plan, a set of approach, departure, or arrival waypoints is inserted into the flight plan—along with a header line describing the selected instrument procedure (Figure D-2). The original enroute portion of the flight plan remains active, unless the pilot ‘activates’ the instrument procedure; which may be done when the procedure is loaded or at a later time.

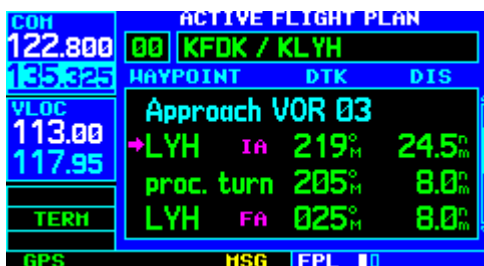

**Figure D-2 Active Flight Plan Page**

Flight plans can also be stored with an approach, departure, or arrival. Keep in mind that the active flight plan is erased when the unit is turned off and overwritten when another flight plan is activated. When storing flight plans with an approach, departure, or arrival, the GNS 430 uses the waypoint information from the current database to define the waypoints. If the database is changed or updated, the GNS 430 automatically updates the information if the procedure has not been modified. If an approach, departure or arrival procedure is no longer available, the flight plan becomes locked until the procedure is deleted from the flight plan or the correct database is installed. For information on loading an approach, departure, or arrival, see Section 6.1. See Section 5.1 for instructions on saving and copying flight plans.

**Can I file slant Golf ('/G') using my GPS?**

Yes, the pilot may file a flight plan as /G if the GNS 430 is a certified A1 or A2 installation. If flying enroute, the pilot may file /G with an expired database only after having verified all route waypoints. Non-precision approaches may not be flown with an expired database. See an approved Airplane Flight Manual Supplement for more information.

**What does the OBS key do and when do I use it?**

The **OBS** Key is used to select manual (OBS mode) or automatic sequencing of waypoints. Activating OBS mode (as indicated by an OBS annunciation directly above the **OBS** Key) holds the current ‘active to’ waypoint as the navigation reference and prevents the GPS from sequencing to the next waypoint. When OBS mode is cancelled, automatic waypoint sequencing is selected, and the GNS 430 automatically selects the next waypoint in the flight plan once the aircraft has crossed the present active-to waypoint.



| NORMAL (no 'OBS' annunciator)                  | OBS   |
|--|---|
| Automatic sequencing of waypoints              | Manual sequencing- 'holds' on selected waypoint                       |
| Change in HSI does not affect CDI deflection   | Manually select course to next waypoint from HSI                      |
| Always navigates 'TO' the active waypoint      | Indicates 'TO' or 'FROM' waypoint                                     |
| Must be in this mode for final approach course | Cannot be set for final approach course or published holding patterns |

When OBS mode is active, the GNS 430 allows the pilot to select the desired course to/from a waypoint using the HSI (much like a VOR) and display a to/from flag for the active-to waypoint. If an external course input is not available, the pilot may select the OBS course on-screen, via a 'Select OBS Course' pop-up window. With OBS mode cancelled, the CDI always displays a 'TO' indication for the next waypoint once the aircraft has crossed the active waypoint (provided the active waypoint is not the last waypoint). Refer to Section 6.2 for an example using the **OBS** Key.

One application for the **OBS** Key is holding patterns. The **OBS** Key is used to suspend waypoint sequencing and select the desired course along the waypoint side of the hold. For many approach operations, setting and resetting of waypoint sequencing is automatic. Holding patterns that are part of an approach automatically disable waypoint sequencing, then re-enable waypoint sequencing after one time around the holding pattern. A 'SUSP' annunciation appears directly above the **OBS** Key (Figure D-3) to indicate that automatic waypoint sequencing is temporarily suspended and course selection is not available. If more than one trip around the holding pattern is desired, press the **OBS** Key to again suspend waypoint sequencing. An example of this operation is an approach which begins with a holding pattern at the initial approach fix (IAF). See Section 6.2, Flying an Approach with a Hold for more information on the 'SUSP' annunciation and approaches with holding patterns.



Figure D-3 'SUSP' Annunciation

**When should I use the OBS key to return to auto sequencing, and what happens when I do?**

The most common application for using the **OBS** Key is the missed approach. The GNS 430 suspends automatic waypoint sequencing (indicated by a ‘SUSP’ annunciation directly above the **OBS** Key; see Figure D-4) when the aircraft crosses the missed approach point (MAP). This prevents the GNS 430 from automatically sequencing to the missed approach holding point (MAHP). If a missed approach is required, press the **OBS** Key to return to automatic waypoint sequencing and sequence the approach to the MAHP. See Section 6.2, Flying the Missed Approach for more information on missed approaches.



Figure D-4 ‘SUSP’ Annunciation

**Why won’t my unit automatically sequence to the next waypoint?**

The GNS 430 only sequences flight plan waypoints when automatic sequencing is enabled (i.e., no ‘OBS’ or ‘SUSP’ annunciation directly above the **OBS** Key). For automatic sequencing to occur, the aircraft must also cross the ‘bisector’ of the turn being navigated. The bisector is a perpendicular line between two flight plan legs which crosses through the waypoint common to both legs.

**How do I skip a waypoint in an approach, departure or arrival?**

The GNS 430 allows the pilot to manually select any approach, departure, or arrival leg as the active leg of the flight plan. This procedure is performed from the Active Flight Plan Page by highlighting the desired waypoint and pressing the **Direct-to** Key twice, then press the **ENT** Key to approve the selection (Figure D-5). The GPS then provides navigation along the selected flight plan leg, so be sure to have clearance to that position. See Section 5.2, Shortcuts for more information.



Figure D-5 Activate Leg Window

**How do I fly the GPS with an autopilot and DG heading bug?**

If the installation does not have an HSI, the pilot should make the course selections on the external CDI’s OBS knob and the DG heading bug.

### When does turn anticipation begin, and what bank angle is expected?

The GNS 430 smooths adjacent leg transitions based upon a nominal 15° bank angle (with the ability to roll up to 25°) and provide three pilot cues for turn anticipation:

- 1) A waypoint alert ('NEXT DTK ###°') flashes in the lower right corner of the screen 10 seconds before the turn point.
- 2) A flashing turn advisory ('TURN TO ###°') appears in the lower right corner of the screen when the aircraft is to begin the turn. Set the HSI to the next DTK value and begin the turn.
- 3) The To/From indicator on the HSI (or CDI) flips momentarily to indicate that the aircraft has crossed the midpoint of the turn. For more information on waypoint alerts and turn advisories, see Sections 6.2 and 6.3.

### When does the CDI scale change, and what does it change to?

The GNS 430 begins a smooth CDI scale transition from the 5.0 nm (enroute/oceanic mode) to the 1.0 nm (terminal mode) scale 30 nm from the destination airport (Figures D-6 and D-7). The CDI scale further transitions to 0.3 nm (approach mode) at 2 nm prior to the FAF during an active approach. If the pilot is in a missed approach situation, and would like to return the CDI to the 1 nm scale, activate the missed approach sequence by pressing the **OBS** Key, as described in Section 6.2, Flying the Missed Approach. The CDI scale is also 1.0 nm (terminal mode) within 30 nm of the departure airport.



Figure D-6 CDI at 1 nm Scale

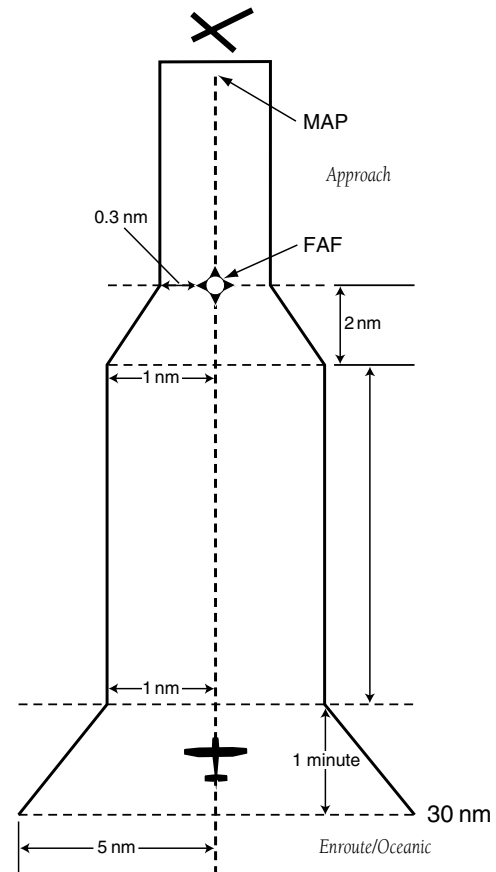

CDI Scale Transition

Figure D-7 CDI Scale Transition

## Why does my CDI not respond like a VOR when OBS mode is active?

Unlike a VOR, the CDI scale used on GPS equipment is based on the cross-track distance to the desired course, not an angular relationship to the destination (Figure D-8). Therefore, the CDI deflection on the GPS is constant regardless of the distance to the destination, and does not become less sensitive when further away from the destination. For more information on the CDI scale, see Section 10.4.

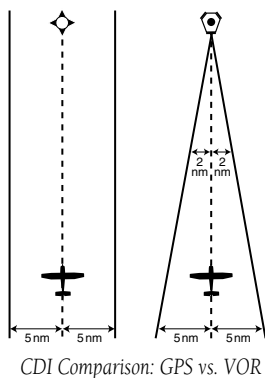

Figure D-8 CDI Comparison

## What is the correct missed approach procedure? How do I select the missed approach holding point?

To comply with TSO specifications, the GNS 430 does not automatically sequence past the MAP. The active-to waypoint sequences to the first waypoint in the missed approach procedure when the **OBS** Key is pressed after crossing the MAP. All published missed approach procedures must be followed, as indicated on the approach plate.

To execute the missed approach procedure prior to the MAP (not recommended), select the Active Flight Plan Page, highlight the MAHP, press the **Direct-to** Key, and then press the **ENT** Key twice.

## How do I re-select the same approach or activate a new approach after a missed approach?

After flying all missed approach procedures, the pilot may reactivate the same approach for another attempt from the Procedures Page. Once given clearance for another attempt, activate the approach from the Procedures Page by highlighting 'Activate Approach?' and then pressing the **ENT** Key. The GNS 430 provides navigation along the desired course to the waypoint and rejoin the approach in sequence from that point on. See Section 5.2, Active Flight Plan Options for information on activating a specific flight plan leg.

To activate a new approach for the same airport, select the new procedure from the Procedures Page. To view the Procedures Page, press the **PROC** Key and turn the large **right** knob to highlight 'Select Approach?'. Press the **ENT** Key and turn the large **right** knob to highlight the new desired approach. Press the **ENT** Key to select the approach, then select the desired transition. Finally, highlight 'Activate?' at the bottom right corner of the screen and press the **ENT** Key to activate the new approach.

To activate a new approach to a different airport, press the **Direct-to** Key and select the desired airport using the small and large **right** knobs. Press the **ENT** Key to accept the selected airport, then follow the steps in the preceding paragraph to select an approach for the new airport. See Section 6.1 for more information on selecting and activating approaches.

**A**

Abbreviations 7-4, 7-6, 7-8, 7-14, 7-15, 7-17, 13-9  
 Accessories 1-1  
 Activate an existing flight plan in reverse 5-4  
 Activate Leg 5-10, 5-15, D-4  
 Activate the approach 6-3, 6-4, 6-10, 6-19, D-6  
 Activating flight plans 5-4  
 Active flight plan options 5-8, 5-10 – 5-13  
 Active frequency 1-9, 2-1, 2-2, 2-5, 6-28, 6-33, 9-1, 9-2  
 Active leg 1-12, 3-2, 5-9, 6-7, 6-8, 6-11, 6-13, 6-17, 6-18,  
 6-21, 6-30, 6-31, 6-32, D-4  
 Airport approach page 7-8, 7-10, D-1  
 Airport frequencies 2-3, 2-5  
 Airport location page 7-2, 7-4, 8-5  
 Airport runway page 7-5  
 Airport type 7-4, 7-6, 7-8  
 Airspace alert messages 1-17, 1-18, 8-13, 10-23  
 Airspace information 1-17  
 Altitude 3-19, 3-23, 3-24, 3-25, 13-1, 13-9  
 Altitude buffer 8-13, 10-20, 10-22  
 Annunciator 1-8, 1-18, 3-16, 8-11, 13-1, D-1, D-3  
 Approach, best available 7-4  
 Approach procedures 6-1, 6-8, 6-9, 6-13, 6-17, 6-20, 6-32,  
 7-8, 9-3, 11-10, D-6  
 Arrivals 1-4, 1-14, 1-15, 5-9, 5-12, 5-14, 6-1, 7-1, 7-11,  
 13-3  
 Arrival alarm 10-20, 10-21, 10-24, 13-1  
 Auto-tuning 2-3, 9-2  
 Automatic sequencing D-3  
 Automatic squelch 1-3, 2-1  
 Automatic zoom 3-9, 3-11  
 AUX page group 10-1, 11-3  
 Aviation data 3-11, 3-15

**B**

Backlighting 10-28, 13-2, 13-3  
 Baro-corrected altitude 11-6  
 Bearing 1-6, 1-11, 1-12, 3-3, 3-7, 3-12, 3-13, 3-20, 3-21,  
 5-9, 5-13, 8-4, 8-6, 8-8, 8-9, 13-9, 13-12  
 Bottom row keys 1-4

**C**

Cautions v, 11-4, 11-10  
 CDI key 1-4, 6-26, 6-32, 6-33, 9-4, 13-2, 13-7  
 CDI scale 3-2, 6-11, 6-15, 6-19, 6-29, 6-30, 10-20, 10-21,  
 10-23, 10-24, D-5, D-6  
 CDI switching 6-33  
 Checklists 1-7, 10-12, 10-14, 10-15  
 Closest point of flight plan 13-4  
 CLR key 1-3  
 COM configuration 10-28, 10-30  
 COM flip-flop Key 1-3  
 COM power/volume knob 1-3  
 COM volume 1-5  
 COM window 1-9, 1-13, 2-2 – 2-6, 8-4, 8-8, 8-9, 8-12, 9-1  
 Contrast 10-28, 10-29  
 Copying flight plans D-2  
 Course from fix flight plan 6-21  
 Creating a flight plan 6-5  
 Creating user waypoints 7-19  
 Crossfill 3-4, 5-6, 10-2, 10-3, 10-8, 10-9, 10-10

**D**

Database confirmation page 1-6, A-1  
 Database subscriptions 1-6  
 Data fields 1-12, 3-4, 3-6, 3-12, 3-13, 3-19, 3-21, 5-10,  
 10-5  
 Date and time 10-3, 10-11, 10-18, 10-22, D-1  
 Declutter 1-11, 3-6  
 Default NAV page 1-10  
 Delete all flight plans 5-7  
 Delete user waypoints 13-2  
 Deleting flight plans 5-5  
 Density altitude 10-1, 10-2, 10-3, 10-7  
 Departures 1-4, 1-14, 1-15, 5-9, 5-12, 5-14, 6-1, 6-25, 7-1,  
 7-13, 9-3, 13-3  
 Departure time 10-7, 10-12, 10-16  
 Desired track 1-11, 1-12, 3-3, 3-6, 5-8, 6-15, 6-23, 6-25,  
 10-3, 13-7, 13-12, 13-13  
 Direct-to key 1-3  
 Direct-to navigation 4-5  
 Display backlighting 13-2, 13-3  
 Display contrast 10-28, 10-29

DIS (distance) 1-11, 1-12, 3-3, 3-6, 5-8, 5-10, 6-6, 6-15, 6-21, 6-23, 6-29, 7-14, 7-17, 7-18, 7-21, 10-3, 10-7, 10-25, 13-9, 13-12  
DME arc 3-2, 6-14  
DOP 3-22, 3-23, 12-1, 13-3, 13-9, 13-12  
Duplex operations 8-9  
Duplicate waypoints 7-3

**E**

Emergency channel select 2-5  
ENT Key 1-3  
EPE (estimated position error) 3-22, 3-23, 12-1, 13-9, 13-12  
ETA 3-3, 5-10, 10-3, 10-7, 13-9, 13-13  
ETE 1-12, 3-3, 5-10, 10-3, 10-7, 13-9, 13-13

**F**

FDE (fault detection and exclusion) 1-8, 12-1, 12-2, 13-9  
Field elevation 7-4  
Flight phases 10-13, 10-18, 12-1  
Flight planning page 10-1, 10-2, 10-4, 10-6, 10-7, 10-8  
Flight plans 1-4, 1-5, 1-18, 1-19, 4-2, 5-1, 5-6, 5-7, 10-2, 10-3, 10-9, 13-3, 13-5, 13-7, D-2  
Flight plan catalog 1-18, 1-19, 5-1, 5-2, 5-3 – 5-9, 6-4  
Flight timers 10-12, 10-15, 10-16  
FLTA (forward looking terrain avoidance) 11-5, 11-7  
FPL key 1-4  
Frequency fields 1-3  
Frequency selection 9-1  
Fuel planning 10-1 – 10-4  
Full screen map 3-12

**G**

Generic timer 10-15, 10-16  
GPS iv  
GPS-MSL altitude 11-6, 11-10  
GPS receiver status 3-22, 3-23  
GPS window 1-9  
Graphic “track” indicator 3-19  
Ground speed 1-11, 1-12, 3-3, 3-6, 3-13, 3-19, 3-23, 3-24, 6-23, 6-25, 10-3, 10-5, 10-7, 10-12, 10-16, 10-17, 13-13  
Ground track 1-11, 1-12, 3-3, 3-14, 3-19, 13-13

**H**

Hold 6-9, 6-11, 6-24  
Hold, in an approach 6-9, 6-23, D-3  
Holding pattern 5-15, 6-9 – 6-12, 6-24, D-3

**I**

Ident audio 9-1  
IFR procedures 1-14  
ILS approach 6-26, 6-28, 6-30, 6-33, 9-3  
Imminent obstacle impact 11-12  
Imminent terrain impact 11-7, 11-12  
Insert the Data card A-1  
Instrument panel self-test page 1-6  
INTEG annunciator D-1  
Intersections 1-11, 1-15, 7-1, 8-1, 8-2, 8-6  
Inverting Flight Plans 5-4  
IOI 11-12  
ITI 11-7, 11-12

**K**

Keys and knobs 1-2, 1-3  
Key and knob functions 1-2

**L**

Land data 1-5, 3-9, 3-11, 13-5  
Land data page 1-5  
Large left knob 1-3  
Large right knob 1-3  
Left-hand Keys and Knobs 1-3  
Loading an approach D-2  
Local time 10-22, 10-26, 10-27  
Locked waypoints 13-2

**M**

Magnetic variation 7-15, 10-21, 10-24  
Main page groups 8-1, 10-1  
Manual sequence 6-21, 6-24, 6-25  
MAP (missed approach point) 4-1, 6-3  
Map datums 10-20, 10-22, 10-26  
Map direct-to 3-7  
Map orientation 3-9, 3-10

Map page 1-11, 3-5, 3-6, 3-7, 3-9, 3-13, 4-5, 6-7, 6-8, 6-13, 6-17, 6-18, 6-23, 6-30, 7-17, 7-19, 10-20, 13-5  
 Map page options 3-9  
 Map panning 3-7  
 Map range 1-2, 1-3, 1-11, 3-6, 3-7, 3-11  
 Map setup 3-6  
 Max speed 10-17  
 Measurement units 1-5, 10-20, 10-21, 10-24, 10-25  
 MENU key 1-3  
 Messages 1-4, 1-17, 1-18, 3-23, 3-26, 8-13, 10-3, 10-9, 10-10, 10-11, 10-22, 10-23, 13-1  
 Message page 1-8, 1-18, 2-6  
 Missed approach 4-1, 6-3, 6-8 – 6-11, 6-13, 6-17, 6-20, 6-22, 6-23, 6-24, 6-32, 11-10, 13-6, D-1, D-4, D-5, D-6  
 MSA (minimum safe altitude) 3-3, 3-19, 13-10, 13-13  
 MSG key 1-4

## N

NAVAID iv, 3-10, 3-20, 13-10  
 NAVCOM page 1-10, 1-13, 1-15, 2-4, 3-17, 3-18, 6-5  
 NavData card 1-6, 1-14, 3-25, A-1  
 Navigation terms 1-11, 1-12, 3-13, 13-12  
 NAV page group 1-5, 2-4, 3-1  
 NDB 1-11, 1-15, 3-5, 3-20, 3-25, 6-3, 7-2, 7-4, 7-15, 7-17, 7-18, 7-21, 8-1, 8-3, 8-6, 13-10  
 Nearest (NRST) airspace page 1-17  
 Nearest (NRST) pages 1-15  
 Nearest airport criteria 10-28, 10-29, 11-5, 11-6  
 nearest airport page 1-15, 1-16, 1-17, 2-3, 8-2, 8-4, 8-5, 10-28  
 Nearest airspace 1-15  
 Nearest ARTCC 1-15, 2-4, 8-8  
 Nearest FSS 1-15, 8-2, 8-9  
 Nearest intersection page 1-15  
 Nearest NDB page 1-15  
 Nearest user waypoints page 1-15  
 Nearest VOR page 1-15  
 NRST page group 1-16, 8-1

## O

Obstacle database 11-4  
 OBS key 1-4, 6-8, 6-9, 6-11, 6-12, 6-13, 6-17, 6-20, 6-22 – 6-25, 6-32, 13-1, 13-6, D-2 – D-6  
 Odometer 10-17  
 Overzoom 3-6

## P

Packing List 1-1  
 Page groups 1-3, 3-1, 8-1, 10-1  
 PDA (premature descent alert) 11-4, 11-5, 11-8 – 11-12  
 Pointer, panning 3-7, 3-8, 3-12, 4-5, 7-19  
 Position format 1-5, 10-22, 10-25  
 Position page 3-19, 3-20, 3-21, 13-1, 13-5  
 Power on 1-3, 1-5  
 Procedures page 1-14, 6-1 – 6-4, 6-18, 7-12, 7-14, 9-3, D-6  
 Procedure turn 5-15, 6-4, 6-7, 6-27, 6-29, 6-30, 6-33  
 PROC key 1-4, 1-14, 5-9, 6-1, 6-2, 6-3, 6-5, 6-9, 6-10, 6-14, 6-17, 6-18, 6-24, 6-28, 9-3, D-6

## R

Radar coverage 7-4  
 RAIM prediction 10-13, 10-17  
 RAIM protection limits 10-18  
 Reference waypoint 3-19, 3-20, 3-21, 3-25, 5-9, 5-13, 7-17, 7-18, 7-19, 7-21, 7-23  
 Remove the Data card A-1  
 Removing approaches 5-14  
 Rename a user waypoint 7-23  
 Required terrain clearance 11-5, 11-7, 11-12  
 Right-hand keys and knobs 1-3  
 RNG key 1-3, 3-6, 3-15, 7-5, 7-6  
 Roads 3-7, 3-12  
 RTC 11-5, 11-7, 11-12  
 Runway information 1-15, 8-5

## S

Satellite status page 1-8, 3-22, 12-1  
 Scheduler message 13-6  
 Scroll bar 1-4, 3-18, 8-4, 8-6  
 Select approach 1-14, 5-11, 6-1, 6-4, 6-9, 7-10, 9-3, D-6  
 Select arrival 1-14, 5-12, 6-1  
 Select departure 1-14, 5-12, 6-1  
 Self test 1-5  
 Setup 1 page 10-20, 10-22 – 10-26  
 Setup 2 page 10-27, 10-28, 10-29  
 Shortcuts 4-4, 5-14  
 SIDs 1-14, 12-2  
 Signal strength 1-8, 3-22, 3-23  
 Sky view 3-22  
 Small left knob 1-3  
 Small right knob 1-3  
 Software/database version 10-12  
 Sort list 5-7, 5-8, 10-15  
 Specifications v, B-1  
 Squelch 2-1, 13-11  
 Standby frequency 1-9, 2-2, 7-16, 8-8, 8-10  
 STARs 1-14, 12-2  
 Stuck microphone 2-5  
 Sunrise/sunset times 10-18  
 SUSP (suspend annunciation) 6-8, 6-11, 6-13, 6-17, 6-20,  
 6-22 – 6-25, 6-32, 13-1, D-3, D-4  
 Symbols 3-2, 3-5, 3-16, 7-15

## T

Target pointer 3-7, 3-8, 7-19  
 Terms 13-1  
 Terrain i, 1-10, 3-14, 3-15, 3-16, 11-1, 11-2 – 11-8, 11-11,  
 11-12  
 Terrain/obstacle database 11-1, 11-2, 11-3, 11-11  
 Terrain alerts 11-7, 11-12  
 Terrain page 1-10, 3-14, 3-15, 3-16, 11-2, 11-7, 11-11  
 Terrain phase of flight 11-4, 11-7  
 Terrain separation iv  
 Timers 10-12, 10-15  
 Track (TRK) 1-6, 1-11, 1-12, 3-3, 3-6, 3-10, 3-12, 3-13, 3-14,  
 3-19, 3-23, 5-8, 6-15, 6-23, 6-25, 6-30, 6-33, 10-3,  
 10-7, 10-21, 13-7, 13-12, 13-13, D-6

Transitions 5-11, 5-12, 6-1, 6-5, 6-10, 6-18, 7-8, 7-9, 7-11,  
 7-13, 9-3, 13-3, D-5  
 Trip planning 10-1, 10-2, 10-3, 10-6  
 Trip statistics 10-12, 10-17  
 True airspeed 10-1, 10-2, 10-3, 10-7  
 Tuning cursor 1-3, 1-9, 2-1, 2-2, 9-1  
 Turn advisories D-5  
 Turn anticipation 13-7, D-5

## U

Units of measure 1-5, 10-20, 10-21, 10-24, 10-25  
 User waypoint list 7-22, 7-23, 7-24  
 User waypoint page 7-17, 7-18, 7-20 – 7-23, 8-8  
 Utility page 10-12, 10-14, 10-17, 10-18, 10-19

## V

Vectors-to-final 3-2, 6-17  
 Vertical navigation 3-24, 13-1, 13-11  
 Vertical navigation page 1-10  
 VLOC audio 9-1  
 VLOC flip-flop key 1-3, 1-13, 6-29, 6-33, 7-16, 8-6, 8-7, 8-  
 10, 9-2, 9-3, 9-4, 13-6, 13-8  
 VLOC volume knob 1-3, 9-1  
 VLOC window 1-9, 1-13, 2-2, 3-18, 6-26, 6-28, 7-7, 7-16,  
 8-6, 8-7, 8-10, 9-1, 9-3, 9-4  
 Volume 1-3, 1-5, 2-1, 9-1  
 VORs 1-11, 1-15, 3-10, 3-15, 4-2, 7-1, 7-15, 8-1, 8-2, 8-6  
 VSR (vertical speed required) 3-3, 3-26, 13-11, 13-13

## W

Warranty vi  
 Waypoint alerts D-5  
 Waypoint list 7-22, 7-23, 7-24  
 Waypoint sequencing 3-2, 6-12, 6-24, 13-1, D-2, D-3, D-4  
 Weather broadcast 7-15  
 Winds aloft 10-1, 10-2, 10-3, 10-7  
 WPT page group 5-15, 7-1, 7-2, 7-16







Garmin International, Inc.  
1200 East 151st Street  
Olathe, KS 66062, U.S.A.  
p: 913.397.8200 f: 913.397.8282

Garmin AT, Inc.  
2345 Turner Road SE  
Salem, OR 97302, U.S.A.  
p: 503.391.3411 f: 503.364.2138

Garmin (Europe) Ltd.  
Unit 5, The Quadrangle  
Abbey Park Industrial Estate  
Romsey, SO51 9DL, U.K.  
p: 44/0870.8501241 f: 44/0870.8501251

Garmin Corporation  
No. 68, Jangshu 2nd Road  
Shijr, Taipei County, Taiwan  
p: 886/2.2642.9199 f: 886/2.2642.9099

[www.garmin.com](http://www.garmin.com)